

USPTO Update

Andrei Iancu

*Under Secretary of Commerce for Intellectual Property and Director of the
United States Patent and Trademark Office*



UNITED STATES
PATENT AND TRADEMARK OFFICE

uspto

10 Million Patents



NOTABLE PATENTS IN AMERICAN HISTORY



1790: First US Patent Issued to Samuel Hopkins



1849: Patent Issued to Future President Abraham Lincoln

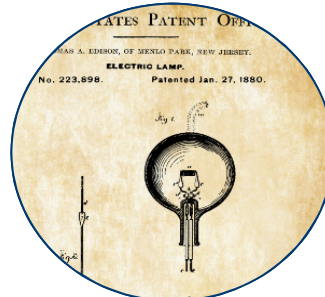

1880: Patent Issued to Thomas Edison for the Lightbulb

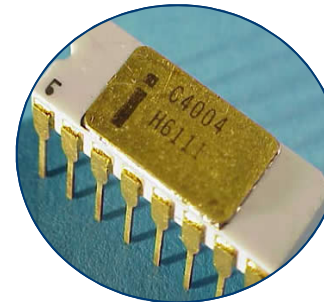

1974: Patent Issued to Ted Hoff for the Microprocessor

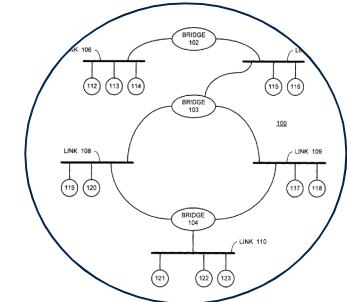

2008: Patent Issued to Radia Perlman for Internet STP

1794: Patent Issued to Eli Whitney for the Cotton Gin

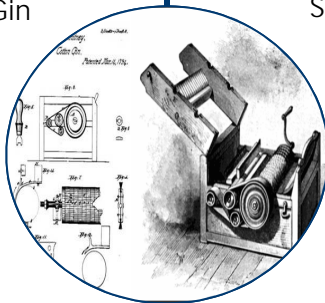

1876: Patent Issued to Alexander Bell for the Speaking Telephone

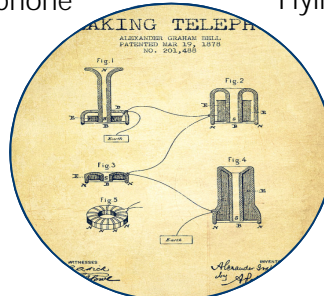

1906: Patent Issued to the Wright Brothers for a Flying Machine

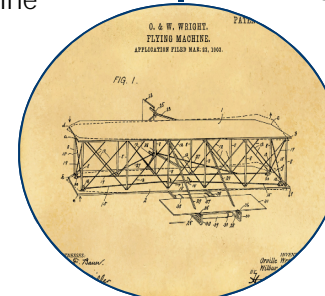

1980: Patent Issued to Cohen and Boyer for Recombinant DNA Techniques



OVERVIEW

- USPTO Statistics
- Patent Trial and Appeal Board
- Subject Matter Eligibility

fiveIPoffices

European Patent Office /// Japan Patent Office ///
Korean Intellectual Property Office /// State Intellectual
Property Office of the People's Republic of China ///
United States Patent and Trademark Office



USPTO FILING STATISTICS: Recent Applications Up, Backlog Down

From 2009- Present

Backlog - Down ~30%

Filings - Up ~32%



April 2018

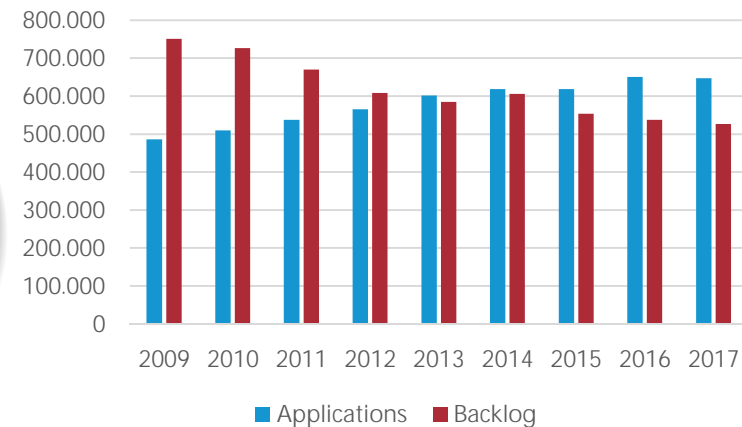

USPTO FILING STATISTICS: First Office Action Pendency Down

First Office Action Pendency

decreased ~40% since 2009.

Jan 2009	FOA Pendency = 26 months
April 2018	FOA Pendency = 15.6 months

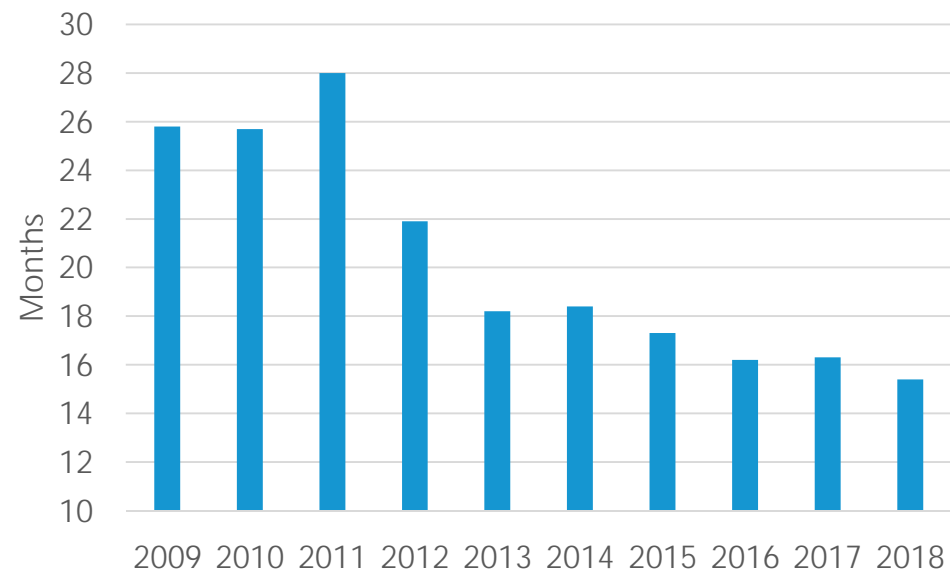

USPTO FILING STATISTICS: Total Pendency Down

Total Pendency

decreased ~29% since 2009.

Jan 2009	Total Pendency = 34 months
April 2018	Total Pendency = 24.3 months

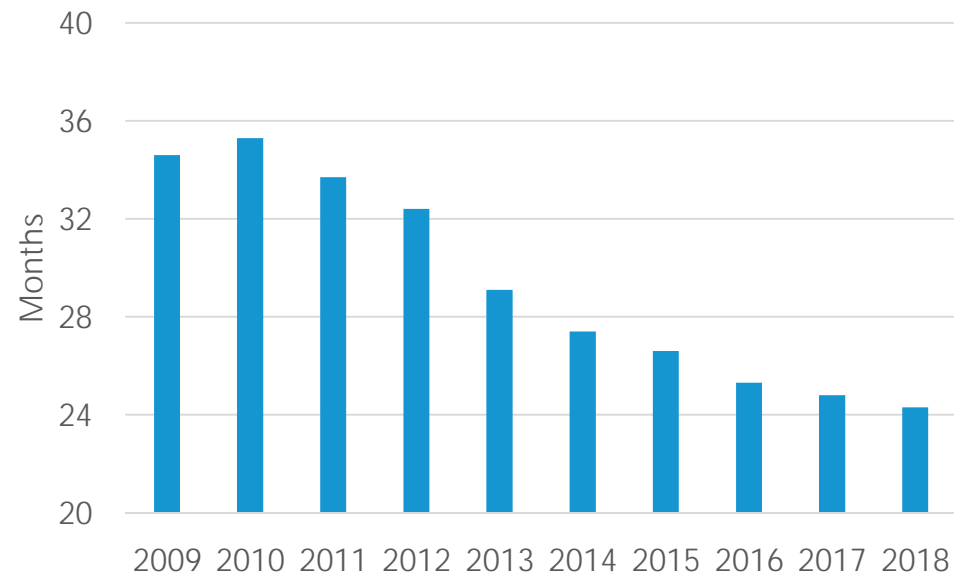

PTAB STATISTICS: Ex Parte Backlog And Pendency Down

Backlog

decreased ~52% since 2012.

FY 2012	~26,500 appeals
FY 2017	~13,000 appeals

Average Pendency

decreased ~35% since 2012.

FY 2012	Pendency = 23 months
FY 2018	Pendency = 14.9 months

Pending Appeals

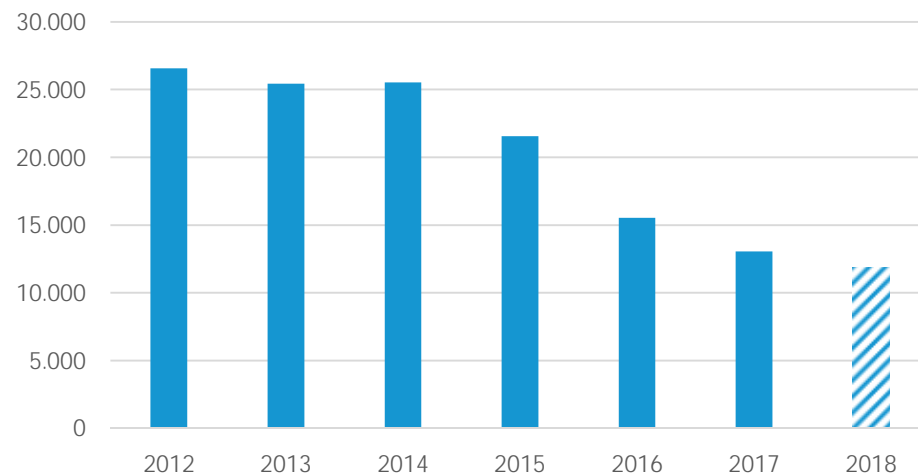

PTAB RECENT DEVELOPMENTS: Supreme Court Addresses AIA Trials



- Oil States v. Green Energy – AIA trial proceedings can continue
- SAS v. Iancu – AIA trial proceedings must address all claims challenged

PTAB RECENT DEVELOPMENTS: Consistency Of Claim Construction



FEDERAL REGISTER

The Daily Journal of the United States Government

- Proposed rule to move AIA trial proceedings from BRI claim construction standard to the standard applied by Federal Courts

83 Fed. Reg. 90 (May 9, 2018. Comment deadline July 9, 2019)



SUBJECT MATTER ELIGIBILITY: Recent Guidance Issued



Memorandum – Step 2 of the Alice/Mayo test:
Document factual support and consider § 112-like considerations

