

# **Guidelines for Examination in the European Patent Office**

November 2014



## List of Contents

### General Part

<b>Contents</b>	<b>a</b>
<b>1. Preliminary remarks</b>	<b>1</b>
<b>2. Explanatory notes</b>	<b>1</b>
2.1 Overview	1
2.2 Abbreviations	3
<b>3. General remarks</b>	<b>4</b>
<b>4. Work at the EPO</b>	<b>5</b>
<b>5. Survey of the processing of applications and patents at the EPO</b>	<b>6</b>
<b>6. Contracting States to the EPC</b>	<b>8</b>
<b>7. Extension to states not party to the EPC</b>	<b>9</b>

### Part A – Guidelines for Formalities Examination

<b>Contents</b>	<b>a</b>
<b>Chapter I Introduction</b>	<b>I-1</b>
<b>Chapter II Filing of applications and examination on filing</b>	<b>II-1</b>
<b>Chapter III Examination of formal requirements</b>	<b>III-1</b>
<b>Chapter IV Special provisions</b>	<b>IV-1</b>
<b>Chapter V Communicating the formalities report; amendment of application; correction of errors</b>	<b>V-1</b>
<b>Chapter VI Publication of application; request for examination and transmission of the dossier to Examining Division</b>	<b>VI-1</b>
<b>Chapter VII Languages</b>	<b>VII-1</b>
<b>Chapter VIII Common provisions</b>	<b>VIII-1</b>

<b>Chapter IX</b>	<b>Drawings</b>	<b>IX-1</b>
<b>Chapter X</b>	<b>Fees</b>	<b>X-1</b>
<b>Chapter XI</b>	<b>Inspection of files; communication of information contained in files; consultation of the Register of European Patents; issuance of certified copies</b>	<b>XI-1</b>

## **Part B – Guidelines for Search**

<b>Contents</b>		<b>a</b>
<b>Chapter I</b>	<b>Introduction</b>	<b>I-1</b>
<b>Chapter II</b>	<b>General</b>	<b>II-1</b>
<b>Chapter III</b>	<b>Characteristics of the search</b>	<b>III-1</b>
<b>Chapter IV</b>	<b>Search procedure and strategy</b>	<b>IV-1</b>
<b>Chapter V</b>	<b>Preclassification (routing) and official classification of European patent applications</b>	<b>V-1</b>
<b>Chapter VI</b>	<b>The state of the art at the search stage</b>	<b>VI-1</b>
<b>Chapter VII</b>	<b>Unity of invention</b>	<b>VII-1</b>
<b>Chapter VIII</b>	<b>Subject-matter to be excluded from the search</b>	<b>VIII-1</b>
<b>Chapter IX</b>	<b>Search documentation</b>	<b>IX-1</b>
<b>Chapter X</b>	<b>Search report</b>	<b>X-1</b>
<b>Chapter XI</b>	<b>The search opinion</b>	<b>XI-1</b>

## **Part C – Guidelines for Procedural Aspects of Substantive Examination**

<b>Contents</b>		<b>a</b>
<b>Chapter I</b>	<b>Introduction</b>	<b>I-1</b>
<b>Chapter II</b>	<b>Formal requirements to be met before the Division starts substantive examination</b>	<b>II-1</b>
<b>Chapter III</b>	<b>The first stage of examination</b>	<b>III-1</b>

<b>Chapter IV</b>	<b>Examination of replies and further stages of examination</b>	<b>IV-1</b>
<b>Chapter V</b>	<b>The final stage of examination</b>	<b>V-1</b>
Annex	Standard marks for indicating amendments or corrections by the Divisions	V-17
<b>Chapter VI</b>	<b>Time limits and acceleration of examination</b>	<b>VI-1</b>
<b>Chapter VII</b>	<b>Other procedures in examination</b>	<b>VII-1</b>
<b>Chapter VIII</b>	<b>Work within the Examining Division</b>	<b>VIII-1</b>
<b>Chapter IX</b>	<b>Special applications</b>	<b>IX-1</b>

## **Part D – Guidelines for Opposition and Limitation/Revocation Procedures**

<b>Contents</b>		<b>a</b>
<b>Chapter I</b>	<b>General remarks</b>	<b>I-1</b>
<b>Chapter II</b>	<b>The Opposition Division</b>	<b>II-1</b>
<b>Chapter III</b>	<b>Opposition</b>	<b>III-1</b>
<b>Chapter IV</b>	<b>Procedure up to substantive examination</b>	<b>IV-1</b>
<b>Chapter V</b>	<b>Substantive examination of opposition</b>	<b>V-1</b>
<b>Chapter VI</b>	<b>Procedure for the examination of the opposition</b>	<b>VI-1</b>
<b>Chapter VII</b>	<b>Details and special features of the proceedings</b>	<b>VII-1</b>
<b>Chapter VIII</b>	<b>Decisions of the Opposition Division</b>	<b>VIII-1</b>
<b>Chapter IX</b>	<b>Costs</b>	<b>IX-1</b>
<b>Chapter X</b>	<b>Limitation and revocation procedure</b>	<b>X-1</b>

## **Part E – Guidelines on General Procedural Matters**

<b>Contents</b>		<b>a</b>
<b>Introduction</b>		<b>1</b>

<b>Chapter I</b>	<b>Communications and notifications</b>	<b>I-1</b>
<b>Chapter II</b>	<b>Oral proceedings</b>	<b>II-1</b>
<b>Chapter III</b>	<b>Taking and conservation of evidence</b>	<b>III-1</b>
<b>Chapter IV</b>	<b>Derogations from the language of the proceedings in oral proceedings</b>	<b>IV-1</b>
<b>Chapter V</b>	<b>Examination by the EPO of its own motion; facts, evidence or grounds not submitted in due time; observations by third parties</b>	<b>V-1</b>
<b>Chapter VI</b>	<b>Interruption and stay of the proceedings</b>	<b>VI-1</b>
<b>Chapter VII</b>	<b>Time limits, loss of rights, further and accelerated processing and re-establishment of rights</b>	<b>VII-1</b>
<b>Chapter VIII</b>	<b>Applications under the Patent Cooperation Treaty (PCT)</b>	<b>VIII-1</b>
<b>Chapter IX</b>	<b>Decisions</b>	<b>IX-1</b>
<b>Chapter X</b>	<b>Appeals</b>	<b>X-1</b>
<b>Chapter XI</b>	<b>Request from a national court for a technical opinion concerning a European patent</b>	<b>XI-1</b>
<b>Chapter XII</b>	<b>Registration of changes of name, transfers, licences and other rights</b>	<b>XII-1</b>



## **Part F – The European Patent Application**

<b>Contents</b>		<b>a</b>
<b>Chapter I</b>	<b>Introduction</b>	<b>I-1</b>
<b>Chapter II</b>	<b>Content of a European patent application (other than claims)</b>	<b>II-1</b>
Annex 1	Checklist for considering the abstract (see F-II, 2.5)	II-13
Annex 2	Units recognised in international practice and complying with Rule 49(10) (see F-II, 4.13)	II-14
<b>Chapter III</b>	<b>Sufficiency of disclosure</b>	<b>III-1</b>

<b>Chapter IV</b>	<b>Claims (Art. 84 and formal requirements)</b>	<b>IV-1</b>
Annex	Examples concerning essential features	IV-27
<b>Chapter V</b>	<b>Unity of invention</b>	<b>V-1</b>
<b>Chapter VI</b>	<b>Priority</b>	<b>VI-1</b>

## **Part G – Patentability**

<b>Contents</b>		<b>a</b>
<b>Chapter I</b>	<b>Patentability</b>	<b>I-1</b>
<b>Chapter II</b>	<b>Inventions</b>	<b>II-1</b>
<b>Chapter III</b>	<b>Industrial application</b>	<b>III-1</b>
<b>Chapter IV</b>	<b>State of the art</b>	<b>IV-1</b>
<b>Chapter V</b>	<b>Non-prejudicial disclosures</b>	<b>V-1</b>
<b>Chapter VI</b>	<b>Novelty</b>	<b>VI-1</b>
<b>Chapter VII</b>	<b>Inventive Step</b>	<b>VII-1</b>
Annex	Examples relating to the requirement of inventive step – indicators	VII-14

## **Part H – Amendments and Corrections**

<b>Contents</b>		<b>a</b>
<b>Chapter I</b>	<b>The right to amend</b>	<b>I-1</b>
<b>Chapter II</b>	<b>Admissibility of amendments – general rules</b>	<b>II-1</b>
<b>Chapter III</b>	<b>Admissibility of amendments – other procedural matters</b>	<b>III-1</b>
<b>Chapter IV</b>	<b>Allowability of amendments – Art. 123(2) and (3)</b>	<b>IV-1</b>
<b>Chapter V</b>	<b>Allowability of amendments – examples</b>	<b>V-1</b>
<b>Chapter VI</b>	<b>Correction of errors</b>	<b>VI-1</b>





# General Part



## Contents

<b>1.</b>	<b>Preliminary remarks</b>	<b>1</b>
<b>2.</b>	<b>Explanatory notes</b>	<b>1</b>
2.1	Overview	1
2.2	Abbreviations	3
<b>3.</b>	<b>General remarks</b>	<b>4</b>
<b>4.</b>	<b>Work at the EPO</b>	<b>5</b>
<b>5.</b>	<b>Survey of the processing of applications and patents at the EPO</b>	<b>6</b>
<b>6.</b>	<b>Contracting States to the EPC</b>	<b>8</b>
<b>7.</b>	<b>Extension to states not party to the EPC</b>	<b>9</b>



## 1. Preliminary remarks

In accordance with Art. 10(2)(a) of the European Patent Convention (EPC), the President of the European Patent Office (EPO) had adopted, effective as at 1 June 1978, the Guidelines for Examination in the European Patent Office.

These Guidelines have been and will be updated at regular intervals to take account of developments in European patent law and practice. Usually, updates only involve amendments to specific sentences or passages on individual pages, in order to bring at least part of the text more closely into line with patent law and EPO practice as these continue to evolve. It follows that no update can ever claim to be complete. Any indication from readers drawing attention to errors as well as suggestions for improvement are highly appreciated and may be sent by e-mail to: [patentlaw@epo.org](mailto:patentlaw@epo.org)

The **most recent** and binding version of the Guidelines for Examination in the European Patent Office is published by the EPO in an electronic, searchable form on the internet via the EPO website:

<http://www.epo.org>

The Guidelines are also issued in printed paper format.

In the PDF and print versions, insertions and deletions compared with the previous version are indicated in the margins by vertical and dual horizontal lines, respectively.

In the HTML publication, modifications can be viewed by ticking the "Show modifications" box in the upper right corner, which displays inserted text with a green background and deleted text in red strikethrough font. For sections in which no changes have been made, the tick box is greyed out.

## 2. Explanatory notes

### 2.1 Overview

The main body of these Guidelines comprises the following eight parts:

Part A:	Guidelines for Formalities Examination;
Part B:	Guidelines for Search;
Part C:	Guidelines for Procedural Aspects of Substantive Examination;
Part D:	Guidelines for Opposition and Limitation/Revocation Procedures;
Part E:	Guidelines on General Procedural Matters;
Part F:	The European Patent Application;
Part G:	Patentability; and
Part H:	Amendments and Corrections

Part A deals with the procedures for formalities examination in grant and opposition proceedings. Part B deals with search matters. Parts C and D relate to procedures to be followed in examination and opposition proceedings respectively. Substantive requirements are dealt with in Parts F, G and H (see below).

Part E deals with procedural matters relevant to several or all of the stages in procedure at the EPO. Part F deals with the requirements which the application must fulfil other than patentability, in particular unity of invention (Art. 82), sufficiency of disclosure (Art. 83), clarity (Art. 84) and the right to priority (Art. 87 to Art. 89). Part G deals with the requirements of patentability provided for in Art. 52 to Art. 57, in particular exclusions from patentability (Art. 52(2) and Art. 53), novelty (Art. 54), inventive step (Art. 56) and industrial application (Art. 57). Part H deals with the requirements relating to amendments and corrections. It relates in particular to questions of admissibility (Rule 80 and Rule 137) and compliance with Art. 123(2) and (3), Rule 139 and Rule 140.

The following notices relating to this and other recent updates have been published in the Official Journal of the European Patent Office:

Re November 2014 update:	OJ EPO 2014, A88
Re September 2013 update:	OJ EPO 2013, 447;
Re June 2012 update:	OJ EPO 2012, 420;
Re April 2010 update:	OJ EPO 2010, 230;
Re April 2009 update:	OJ EPO 2009, 336;
Re December 2007 update:	OJ EPO 2007, 589;
Re June 2005 update:	OJ EPO 2005, 440;
Re December 2003 update:	OJ EPO 2003, 582;
Re October 2001 update:	OJ EPO 2001, 464;
Re February 2001 update:	OJ EPO 2001, 115;
Re June 2000 update:	OJ EPO 2000, 228;
Re July 1999 update:	OJ EPO 1999, 510.

It will be noted that each Part of the Guidelines is divided into Chapters, each sub-divided into numbered sections which are further sub-divided into paragraphs. Cross-references to other paragraphs include the relevant letter of that Part, followed by the Chapter number (a Roman numeral) and then the section and paragraph numbers (thus, e.g. C-V, 4.6 would be used if it were desired to refer to paragraph 4.6 of Chapter V of Part C).

Marginal references to articles and rules without further identification indicate the Articles or Rules of the European Patent Convention which provides authority for what is stated. It is believed that such references avoid the need for extensive quotation from the EPC itself.

It goes without saying that whenever "his" or "he" is used in relation to examiner, applicant, inventor, etc., this should be understood as "her or his" and "she or he", respectively.

## 2.2 Abbreviations

In the Guidelines, the following abbreviations are used:

EPC	European Patent Convention
EPO	European Patent Office
ESOP	European Search Opinion (Rule 62)
OJ EPO	Official Journal of the European Patent Office
Art.	Article
RFees	Rules relating to Fees
WIPO	World Intellectual Property Organization
PCT	Patent Cooperation Treaty
ISA	International Searching Authority
WO-ISA	Written Opinion of the International Searching Authority
IPEA	International Preliminary Examining Authority
IPRP	International Preliminary Report on Patentability
IPER	International Preliminary Examination Report
EESR	Extended European Search Report
ADA	Arrangements for deposit accounts
AAD	Arrangements for the automatic debiting procedure
BNS	back-file conversion numerical system
rec.	recital
Prot. Art. 69	Protocol on the Interpretation of Art. 69 EPC
Prot. Centr.	Protocol on the Centralisation of the European patent system and on its introduction (Protocol on Centralisation)
EVL	Electronic virtual library

References to the European Patent Convention (EPC) are references to the European Patent Convention as amended by the Act revising the EPC of 29 November 2000 and the decision of the Administrative Council of 28 June 2001 adopting the new text of the European Patent Convention (OJ EPO Special editions No. 4/2001, pages 56 *et seq*; No. 1/2003, pages 3 *et seq*; No. 1/2007, pages 1 to 88) and the Implementing Regulations as adopted by decision of the Administrative Council of 7 December 2006 (OJ EPO Special edition No. 1/2007, pages 89 *et seq*) and as subsequently amended by decisions of the Administrative Council of 6 March 2008 (OJ EPO 2008, 124), 21 October 2008 (OJ EPO 2008, 513), 25 March 2009 (OJ EPO 2009, 296 and OJ EPO 2009, 299), 27 October 2009 (OJ EPO 2009, 582), 28 October 2009 (OJ EPO 2009, 585), 26 October 2010 (OJ EPO 2010, 568, 634 and 637), 27 June 2012 (OJ EPO 2012, 442), 16 October 2013 (OJ EPO 2013, 501, and 503) and 13 December 2013 (OJ EPO 2014, A3, and A4).

Where necessary, reference is made to the European Patent Convention of 5 October 1973 as amended by the act revising Article 63 EPC of 17 December 1991 and by the decisions of the Administrative Council of 21 December 1978, 13 December 1994, 20 October 1995, 5 December 1996, 10 December 1998 and 27 October 2005.

The reference to Articles and Rules – and their paragraphs – of EPC 2000 will be as follows: "Article 123, paragraph 2" will be: "Art. 123(2)", "Rule 29, paragraph 7" will be: "Rule 29(7)". Articles and Rules of EPC 1973, of the PCT and Articles of the Rules relating to Fees are referred to in a similar way, e.g. "Art. 54(4) EPC 1973", "Art. 33(1) PCT" and "Art. 10(1) RFees" respectively. Only where deemed appropriate, i.e. in order to avoid confusion, will references to Articles and Rules of the EPC be provided with the extension "EPC 2000".

Decisions and opinions of the Enlarged Board of Appeal will only be referred to with their capital letter and their number, e.g. "G 2/88". Decisions of the Technical Boards of Appeal and the Legal Board of Appeal will be referred to in the same way, e.g., "T 152/82", "J 4/91" and "T 169/88". It is noted that all decisions and opinions of the Enlarged Board of Appeal and all decisions of the boards of appeal of the EPO are published on the Internet (<http://www.epo.org>) (see the Notice from the Vice-President Directorate-General 3 dated 3 July 2002, OJ EPO 2002, 442).

The arrangements for deposit accounts and their annexes, including the arrangements for the automatic debiting procedure plus explanatory notes, are published from time to time as Supplements to the Official Journal of the EPO.

### 3. General remarks

These Guidelines give instructions about the practice and procedure to be followed in the various aspects of the examination of European applications and patents in accordance with the European Patent Convention and its Implementing Regulations (see section 5).

The search and examination practice and procedure as regards PCT applications, as far as the international phase is concerned, are not the subject of these Guidelines, but are dealt with in the **PCT International Search and Preliminary Examination Guidelines**. Whenever considered appropriate, options given in the latter Guidelines and the way they are dealt with by the European Patent Office when acting as Receiving Office, International Searching Authority or International Preliminary Examining Authority are the subject of separate notices published in the Official Journal of the EPO and on the EPO website. It is important to note that Art. 150 EPC states that in case of conflict between the PCT and the EPC, the provisions of the PCT prevail.

These Guidelines are addressed primarily to EPO staff but it is hoped that they will also be of assistance to the parties to the proceedings and patent practitioners, since the success of the European patent system depends on the good cooperation between the parties and their representatives on the one hand and the EPO on the other.



The Guidelines are intended to cover normal occurrences. They should therefore be considered only as general instructions. The application of the Guidelines to individual European patent applications or patents is the responsibility of the examining staff and they may depart from these instructions in exceptional cases. Nevertheless, as a general rule, parties can expect the EPO to act in accordance with the Guidelines until such time as they – or the relevant legal provisions – are amended. Notices concerning such amendments are published in the Official Journal of the EPO and on the EPO website.

It should be noted also that the Guidelines do not constitute legal provisions. For the ultimate authority on practice in the EPO, it is necessary to refer firstly to the European Patent Convention itself including the Implementing Regulations, the Protocol on the Interpretation of Article 69 EPC, the Protocol on Centralisation, the Protocol on Recognition, the Protocol on Privileges and Immunities and the Rules relating to Fees, and secondly to the interpretation put upon the EPC by the Boards of Appeal and the Enlarged Board of Appeal.

Where a decision or an opinion of the Enlarged Board of Appeal is referred to, this is to inform the reader that the practice described has been adopted to take account of the decision or opinion referred to. The same applies to decisions of the Legal or Technical Boards of Appeal.

As regards the search, the EPO also carries out searches for national patent applications from certain countries. The instructions in Part B apply in the main also to such searches.

These Guidelines do not deal with proceedings relating to unitary patent protection (Regulations (EU) No 1257/2012 and 1260/2012, OJ EPO 2013, 111 and 132).

#### **4. Work at the EPO**

The setting up of the EPO represented a major step forward in the history of patents. Its reputation depends on all employees, regardless of nationality, working harmoniously together and giving of their best. But it is on the search, examination and opposition, more than anything else, that the EPO will be judged by the patent world.

Employees of the EPO work with colleagues who not only speak a different language but also come from a different patent background with different training. Some may also have had experience in their national patent office. It is important therefore to remember that all employees in the EPO are working under a common system as laid down in the EPC. They should all apply the same standard and in some instances this will mean abandoning previous habits and ways of thought.

It is also important that the various departments of the EPO and various staff within the same department should not attempt to duplicate one another's efforts. For example, Examining Divisions should not attempt to check the formalities work performed by the Receiving Section or to duplicate the search work performed by the Search Division. One of the purposes of the Guidelines is to make clear where the demarcations of responsibility lie.

It should not be forgotten that the reputation of the EPO will depend not only on quality but also on the speed with which it deals with its work. The EPC imposes various time limits on the parties. Generally speaking there are no corresponding time limits imposed on the EPO, but the European patent system will be judged a success only if examiners and other employees also operate with reasonable expedition.

Finally, it should hardly need stating that all European applications and patents, regardless of their country of origin and the language in which they are written, should receive equal treatment. An international patent system can be credible only if all trace of national bias is absent.

## **5. Survey of the processing of applications and patents at the EPO**

The processing of a European application and of a European patent is carried out in a number of distinct steps which may be summarised as follows:

- (i) the application is filed with the EPO or a competent national authority;
- (ii) the Receiving Section examines the application to determine if a date of filing can be accorded to the application;
- (iii) the formal examination of the application is undertaken by the Receiving Section;
- (iv) in parallel with the formal examination the Search Division draws up an EESR, a copy of which is forwarded to the applicant;
- (v) the application and the search report are published by the EPO either together or separately;
- (vi) on receipt of a request from the applicant, or, if the request has been filed before the search report has been transmitted to the applicant, on confirmation by the applicant that he desires to proceed further with the European patent application, the application is subjected to a substantive examination and an examination of formalities necessary for grant by the Examining Division;

- (vii) provided the requirements of the EPC are met, a European patent is granted for the States designated;
- (viii) the specification of the European patent is published by the EPO;
- (ix) any person may give notice of opposition to the European patent granted; after examining the opposition, the Opposition Division decides whether to reject the opposition, maintain the patent in amended form, or to revoke the patent;
- (x) the patent proprietor may request limitation or revocation of the granted patent; the Examining Division will decide whether this request is to be granted
- (xi) if the European patent is amended, the EPO publishes a new specification of the European patent amended accordingly.

Any decision by an EPO first-instance department which adversely affects a party is subject to review before a Board of Appeal of the EPO. With the exception of matters of importance to the question of interlocutory revision, the appeals procedure is not dealt with in these Guidelines.

## 6. Contracting States to the EPC

The following states are Contracting States\* to the EPC (date of effect of the ratification in brackets):

Albania	(1 May 2010)
Austria	(1 May 1979)
Belgium	(7 October 1977)
Bulgaria	(1 July 2002)
Croatia	(1 January 2008)
Cyprus	(1 April 1998)
Czech Republic	(1 July 2002)
Denmark <sup>1</sup>	(1 January 1990)
Estonia	(1 July 2002)
Finland	(1 March 1996)
Former Yugoslav Republic of Macedonia	(1 January 2009)
France <sup>2</sup>	(7 October 1977)
Germany	(7 October 1977)
Greece	(1 October 1986)
Hungary	(1 January 2003)
Iceland	(1 November 2004)
Ireland	(1 August 1992)
Italy	(1 December 1978)
Latvia	(1 July 2005)
Liechtenstein	(1 April 1980)
Lithuania	(1 December 2004)
Luxembourg	(7 October 1977)
Malta	(1 March 2007)
Monaco	(1 December 1991)
Netherlands <sup>3</sup>	(7 October 1977)
Norway	(1 January 2008)
Poland	(1 March 2004)
Portugal	(1 January 1992)
Romania	(1 March 2003)
Serbia	(1 October 2010)
San Marino	(1 July 2009)
Slovak Republic	(1 July 2002)
Slovenia	(1 December 2002)
Spain	(1 October 1986)
Sweden	(1 May 1978)
Switzerland	(7 October 1977)
Turkey	(1 November 2000)
United Kingdom <sup>4</sup>	(7 October 1977)
(total: 38)	

\* An up-to-date list of the Contracting States to the EPC is published each year in issue No. 4 of the Official Journal of the EPO.

<sup>1</sup> The EPC does not apply to Greenland and the Faroe Islands.

<sup>2</sup> The EPC applies to the territory of the French Republic, including the overseas territories.

<sup>3</sup> The EPC is also applicable to Sint Maarten, Curaçao, Bonaire, Sint Eustatius and Saba, but not to Aruba.

<sup>4</sup> The EPC is also applicable to the Isle of Man. For further information on the registration of European patents, designating the United Kingdom, in overseas states and territories, see OJ EPO 2004, 179.

## **7. Extension to states not party to the EPC**

For extension of European patent applications and patents for states not party to the EPC, see A-III, 12 and sub-sections.



# **Part A**

## **Guidelines for Formalities Examination**





## Contents

### **Chapter I – Introduction I-1**

- 1. Overview I-1**
- 2. Responsibility for formalities examination I-1**
- 3. Purpose of Part A I-1**
- 4. Other Parts relating to formalities I-1**

### **Chapter II – Filing of applications and examination on filing II-1**

- 1. Where and how applications may be filed II-1**
  - 1.1 Filing of applications by delivery by hand or by post II-1
  - 1.2 Filing of applications by fax II-1
  - 1.3 Filing of applications in electronic form II-2
  - 1.4 Filing of applications by other means II-2
  - 1.5 Subsequent filing of documents II-3
  - 1.6 Debit orders for deposit accounts held with the EPO II-3
  - 1.7 Forwarding of applications II-3
  - 1.8 Application numbering systems II-3
    - 1.8.1 Applications filed before 1 January 2002 II-3
    - 1.8.2 Applications filed on or after 1 January 2002 II-4
- 2. Persons entitled to file an application II-4**
- 3. Procedure on filing II-5**
  - 3.1 Receipt; confirmation II-5
  - 3.2 Filing with a competent national authority II-5
- 4. Examination on filing II-6**
  - 4.1 Minimum requirements for according a date of filing II-6
    - 4.1.1 Indication that a European patent is sought II-7
    - 4.1.2 Information concerning the applicant II-7
      - 4.1.3 Description II-7
        - 4.1.3.1 Reference to a previously filed application II-8

4.1.4	Deficiencies	II-9
4.1.5	Date of filing	II-11
<b>5.</b>	<b>Late filing of drawings or parts of the description</b>	<b>II-11</b>
5.1	Late filing of drawings or parts of the description - on invitation	II-11
5.2	Late filing of drawings or parts of the description - without invitation	II-11
5.3	The filing date changes	II-12
5.4	Missing parts based on priority, no change in filing date	II-12
5.4.1	Late-filed missing parts and the priority claim	II-13
5.4.2	The missing parts are completely contained in the claimed priority	II-13
5.4.3	Copy of the claimed priority	II-14
5.4.4	Translation of the priority	II-14
5.5	Withdrawal of late-filed missing drawings/parts of the description	II-15

## **Chapter III – Examination of formal requirements** **III-1**

<b>1.</b>	<b>General</b>	<b>III-1</b>
1.1	Formal requirements	III-1
1.2	Further checks	III-1
<b>2.</b>	<b>Representation</b>	<b>III-2</b>
2.1	Requirements	III-2
2.2	Non-compliance	III-2
<b>3.</b>	<b>Physical requirements</b>	<b>III-2</b>
3.1	General remarks	III-2
3.2	Documents making up the application, replacement documents, translations	III-2
3.2.1	Physical requirements of applications filed by reference to a previously filed application	III-4
3.2.2	Physical requirements of late-filed application documents	III-4
3.3	Other documents	III-4

---

3.4	Signature	III-4
<b>4.</b>	<b>Request for grant</b>	<b>III-5</b>
4.1	General remarks	III-5
4.2	Examination of the Request for Grant form	III-5
4.2.1	Information on the applicant	III-5
4.2.2	Signature	III-5
<b>5.</b>	<b>Designation of inventor</b>	<b>III-6</b>
5.1	General remarks	III-6
5.2	Waiver of right to be mentioned as inventor	III-6
5.3	Designation filed in a separate document	III-6
5.4	Notification	III-6
5.5	Deficiencies	III-7
5.6	Incorrect designation	III-7
<b>6.</b>	<b>Claim to priority (see also F-VI)</b>	<b>III-8</b>
6.1	General remarks	III-8
6.2	Applications giving rise to a right of priority	III-9
6.3	Multiple priorities	III-10
6.4	Examination of the priority document	III-10
6.5	Declaration of priority	III-10
6.5.1	Filing a new priority claim	III-11
6.5.2	Correcting an existing priority claim	III-11
6.5.3	Deficiencies in the priority claim and loss of the priority right	III-11
6.6	Priority period	III-12
6.7	Copy of the previous application (priority document)	III-13
6.8	Translation of the previous application	III-14
6.8.1	Invitation to file the translation before examination	III-14
6.8.2	Invitation to file the translation in examination/opposition	III-15
6.8.3	Loss of rights and legal remedies	III-16
6.8.4	Translation of priority already filed	III-16
6.8.5	Voluntary filing of the translation of the previous application	III-16

---

6.8.6	Declaration replacing the translation	III-17
6.9	Non-entitlement to right to priority	III-17
6.10	Loss of right to priority	III-18
6.11	Notification	III-18
6.12	Copy of the search results for the priority or priorities	III-18
<b>7.</b>	<b>Title of the invention</b>	<b>III-20</b>
7.1	Requirements	III-20
7.2	Responsibility	III-20
<b>8.</b>	<b>Prohibited matter</b>	<b>III-20</b>
8.1	Morality or "ordre public"	III-20
8.2	Disparaging statements	III-21
<b>9.</b>	<b>Claims fee</b>	<b>III-21</b>
<b>10.</b>	<b>Abstract</b>	<b>III-23</b>
10.1	General remark	III-23
10.2	Content of the abstract	III-23
10.3	Figure accompanying the abstract	III-23
<b>11.</b>	<b>Designation of Contracting States</b>	<b>III-23</b>
11.1	General remarks	III-23
11.2	European patent applications filed on or after 1 April 2009	III-23
11.2.1	Designation fee; time limits	III-23
11.2.2	Payment of designation fee	III-24
11.2.3	Consequences of non-payment of the designation fee	III-24
11.2.4	Withdrawal of designation	III-24
11.2.5	Euro-PCT applications entering the European phase	III-25
11.3	European patent applications filed before 1 April 2009	III-25
11.3.1	Designation fee; time limits	III-25
11.3.2	Consequences of non-payment of designation fees	III-26
11.3.3	Amount paid insufficient	III-26
11.3.4	Application deemed to be withdrawn	III-26

11.3.5	Request for Grant form	III-27
11.3.6	Indication of the Contracting States	III-27
11.3.7	Amount payable	III-28
11.3.8	Withdrawal of designation	III-28
11.3.9	Euro-PCT applications entering the European phase before 1 April 2009	III-28

## **12. Extension of European patent applications and patents to States not party to the EPC** **III-29**

12.1	General remarks	III-29
12.2	Time limit for payment of extension fee	III-30
12.3	Withdrawal of extension	III-31
12.4	Extension deemed requested	III-31
12.5	National register	III-31

## **13. Filing and search fees** **III-31**

13.1	Payment of fees	III-31
13.2	Additional fee (if application documents comprise more than thirty-five pages)	III-32
13.3	Additional fee for divisional applications	III-33

## **14. Translation of the application** **III-34**

## **15. Late filing of claims** **III-34**

## **16. Correction of deficiencies** **III-35**

16.1	Procedure formalities officer	III-35
16.2	Period allowed for remedying deficiencies	III-36

## **Chapter IV – Special provisions** **IV-1**

### **1. European divisional applications (see also C-IX, 1)** **IV-1**

1.1	General remarks	IV-1
1.1.1	Pendency of the earlier application	IV-1
1.1.2	Sequences of divisional applications	IV-2
1.1.3	Persons entitled to file a divisional application	IV-3
1.2	Date of filing of a divisional application; claiming priority	IV-3
1.2.1	Date of filing	IV-3

1.2.2	Priority claim of a divisional application	IV-3	
1.3	Filing a divisional application	IV-4	
1.3.1	Where and how to file a divisional application?	IV-4	
1.3.2	Request for grant	IV-5	
1.3.3	Language requirements	IV-5	
1.3.4	Designation of Contracting States	IV-5	
1.3.5	Extension states	IV-6	
1.4	Fees	IV-6	
1.4.1	Filing, search and designation fee(s)	IV-6	
1.4.1.1	Additional fee for divisional applications of second or subsequent generations	IV-6	
1.4.2	Claims fees	IV-7	
1.4.3	Renewal fees	IV-7	
1.5	Designation of the inventor	IV-8	
1.6	Authorisations	IV-9	
1.7	Other formalities examination	IV-9	
1.8	Search, publication and request for examination of divisional applications	IV-9	
<b>2.</b>	<b>Art. 61 applications and stay of proceedings under Rule 14</b>	<b>IV-9</b>	
2.1	General	IV-9	
2.2	Stay of proceedings for grant	IV-10	⊥
2.2.1	Responsible department	IV-10	
2.2.2	Date of the stay of proceedings	IV-10	
2.2.3	Legal nature and effects of the stay	IV-11	
2.2.4	Interruption of time limits	IV-11	
2.2.5	Resumption of the proceedings for grant	IV-11	
2.2.5.1	Resumption after final decision in entitlement proceedings	IV-12	
2.2.5.2	Resumption regardless of the stage of entitlement proceedings	IV-12	
2.3	Limitation of the option to withdraw the European patent application	IV-12	⊥
2.4	Prosecution of the application by a third party	IV-12	⊥
2.5	Filing a new application	IV-12	⊥
2.6	Refusal of the earlier application	IV-13	⊥
2.7	Partial transfer of right by virtue of a final decision	IV-13	⊥
<b>3.</b>	<b>Display at an exhibition</b>	<b>IV-13</b>	

3.1	Certificate of exhibition; identification of invention	IV-13
3.2	Defects in the certificate or the identification	IV-14
<b>4.</b>	<b>Applications relating to biological material</b>	<b>IV-14</b>
4.1	Biological material; deposit thereof	IV-14
4.1.1	New deposit of biological material	IV-15
4.1.2	The application was filed by reference to a previous application	IV-16
4.2	Missing information; notification	IV-17
4.3	Availability of deposited biological material to expert only	IV-17
<b>5.</b>	<b>Applications relating to nucleotide and amino acid sequences</b>	<b>IV-18</b>
5.1	Sequence information filed under Rule 56	IV-19
5.2	Sequence listings of an application filed by reference to a previously filed application	IV-20
5.3	Sequence listings of a divisional application	IV-21
<b>6.</b>	<b>Conversion into a national application</b>	<b>IV-21</b>

## **Chapter V – Communicating the formalities report; amendment of application; correction of errors**

**V-1**

<b>1.</b>	<b>Communicating the formalities report</b>	<b>V-1</b>
<b>2.</b>	<b>Amendment of application</b>	<b>V-1</b>
2.1	Filing of amendments	V-1
2.2	Examination of amendments as to formalities	V-2
<b>3.</b>	<b>Correction of errors in documents filed with the EPO</b>	<b>V-2</b>

## **Chapter VI – Publication of application; request for examination and transmission of the dossier to Examining Division**

**VI-1**

<b>1.</b>	<b>Publication of application</b>	<b>VI-1</b>
1.1	Date of publication	VI-1

---

1.2	No publication; preventing publication	VI-1
1.3	Content of the publication	VI-2
1.4	Publication in electronic form only	VI-3
1.5	Separate publication of the European search report	VI-3
<b>2.</b>	<b>Request for examination and transmission of the dossier to the Examining Division</b>	<b>VI-3</b>
2.1	Communication	VI-3
2.2	Time limit for filing the request for examination	VI-4
2.3	Legal remedy	VI-4
2.4	Transmission of the dossier to the Examining Division	VI-5
2.5	Refund of examination fee	VI-6
2.6	Reduction in examination fee	VI-6
<b>3.</b>	<b>Response to the search opinion</b>	<b>VI-6</b>

## **Chapter VII – Languages** **VII-1**

<b>1.</b>	<b>Provisions concerning the language of the proceedings</b>	<b>VII-1</b>
1.1	Admissible languages; time limit for filing the translation of the application	VII-1
1.2	Language of the proceedings	VII-1
1.3	European divisional applications; Art. 61 applications	VII-1
<b>2.</b>	<b>Derogations from the language of the proceedings in written proceedings</b>	<b>VII-1</b>
<b>3.</b>	<b>Documents to be used as evidence</b>	<b>VII-2</b>
<b>4.</b>	<b>Documents filed in the wrong language</b>	<b>VII-3</b>
4.1	Documents making up a European patent application	VII-3
4.2	Other documents	VII-3



---

<b>5.</b>	<b>Translation of the priority document</b>	<b>VII-4</b>
<b>6.</b>	<b>Authentic text</b>	<b>VII-4</b>
6.1	General remark	VII-4
6.2	Conformity of translation with the original text	VII-4
<b>7.</b>	<b>Certificate of translation</b>	<b>VII-4</b>
<b>8.</b>	<b>Derogations from the language of the proceedings in oral proceedings</b>	<b>VII-5</b>
<b>Chapter VIII – Common provisions</b>		<b>VIII-1</b>
<b>1.</b>	<b>Representation</b>	<b>VIII-1</b>
1.1	Representation by a professional representative	VIII-1
1.2	Representation by an employee	VIII-1
1.3	Common representative	VIII-1
1.4	List of professional representatives; legal practitioners	VIII-2
1.5	Signed authorisation	VIII-2
1.6	General authorisation	VIII-3
1.7	Invitation to file authorisation	VIII-3
<b>2.</b>	<b>Form of documents</b>	<b>VIII-4</b>
2.1	Documents making up the European patent application	VIII-4
2.2	Replacement documents and translations	VIII-4
2.3	Other documents	VIII-4
2.4	Number of copies	VIII-4
2.5	Filing of subsequent documents	VIII-5
<b>3.</b>	<b>Signature of documents</b>	<b>VIII-6</b>
3.1	Documents filed after filing the European patent application	VIII-6
3.2	Documents forming part of the European patent application	VIII-6

3.3	Form of signature	VIII-7
3.4	Joint applicants	VIII-7

## **Chapter IX – Drawings IX-1**

<b>1.</b>	<b>Graphic forms of presentation considered as drawings</b>	<b>IX-1</b>
1.1	Technical drawings	IX-1
1.2	Photographs	IX-1
<b>2.</b>	<b>Representation of drawings</b>	<b>IX-1</b>
2.1	Grouping of drawings	IX-1
2.2	Reproducibility of drawings	IX-2
2.3	Figure accompanying the abstract	IX-2
<b>3.</b>	<b>Conditions regarding the paper used</b>	<b>IX-2</b>
<b>4.</b>	<b>Presentation of the sheets of drawings</b>	<b>IX-2</b>
4.1	Usable surface area of sheets	IX-2
4.2	Numbering of sheets of drawings	IX-3
<b>5.</b>	<b>General layout of drawings</b>	<b>IX-3</b>
5.1	Page-setting	IX-3
5.2	Numbering of figures	IX-4
5.3	Whole figure	IX-4
<b>6.</b>	<b>Prohibited matter</b>	<b>IX-4</b>
<b>7.</b>	<b>Executing of drawings</b>	<b>IX-5</b>
7.1	Drawings of lines and strokes	IX-5
7.2	Shading	IX-5
7.3	Cross-sections	IX-5
7.3.1	Sectional diagrams	IX-5
7.3.2	Hatching	IX-5
7.4	Scale of drawings	IX-5
7.5	Numbers, letters and reference signs	IX-6

7.5.1	Leading lines	IX-6
7.5.2	Arrows	IX-6
7.5.3	Height of the numbers and letters in the drawings	IX-6
7.5.4	Consistent use of reference signs as between description, claims and drawings	IX-7
7.5.5	Consistent use of reference signs as between drawings	IX-7
7.6	Variations in proportions	IX-8
<b>8.</b>	<b>Text matter on drawings</b>	<b>IX-8</b>
<b>9.</b>	<b>Conventional symbols</b>	<b>IX-8</b>
<b>10.</b>	<b>Amendments to drawings</b>	<b>IX-8</b>
<b>11.</b>	<b>Graphic forms of presentation not considered as drawings</b>	<b>IX-9</b>
11.1	Chemical and mathematical formulae	IX-9
11.2	Tables	IX-10
11.2.1	Tables in the description	IX-10
11.2.2	Tables in the claims	IX-10

## **Chapter X – Fees** **X-1**

<b>1.</b>	<b>General</b>	<b>X-1</b>
<b>2.</b>	<b>Methods of payment</b>	<b>X-1</b>
<b>3.</b>	<b>Currencies</b>	<b>X-2</b>
<b>4.</b>	<b>Date considered as date on which payment is made</b>	<b>X-2</b>
4.1	Payment or transfer to a bank account held by the European Patent Organisation	X-2
4.2	Deposit accounts with the EPO	X-2
4.2.1	General remarks	X-2
4.2.2	Payments to replenish a deposit account	X-3
4.2.3	Debiting the deposit account	X-3
4.2.4	Date of receipt of the debit order; insufficient funds	X-3
4.3	Automatic debiting procedure	X-4
<b>5.</b>	<b>Due date for fees</b>	<b>X-4</b>
5.1	General	X-4
5.1.1	Due date	X-4



5.1.2	Amount of the fee	X-5
5.2	Due date for specific fees	X-5
5.2.1	Filing fee and search fee	X-5
5.2.2	Examination fee and designation fee	X-5
5.2.3	Fee for grant and publishing	X-5
5.2.4	Renewal fees	X-5
5.2.5	Claims fees	X-7
5.2.6	Fees for limitation/revocation, opposition, appeal, petition for review	X-7
<b>6.</b>	<b>Payment in due time</b>	<b>X-7</b>
6.1	Basic principle	X-7
6.2	Ten-day fail-safe arrangement	X-7
6.2.1	Requirements	X-7
6.2.2	Application of the ten-day fail-safe arrangement to replenishment of deposit account	X-8
6.2.3	Debit orders	X-8
6.2.4	Payment of fee at the normal fee rate	X-8
6.2.5	Amount of fee payable	X-8
6.2.6	Noting of loss of rights	X-9
<b>7.</b>	<b>Purpose of payment</b>	<b>X-9</b>
7.1	General	X-9
7.1.1	Condition for valid payment	X-9
7.1.2	Purpose of payment	X-9
7.2	Indication of the purpose of the payment in the case of designation fees	X-10
7.3	Indication of the purpose of payment in the case of claims fees	X-10
7.3.1	Claims fees payable on filing the European patent application	X-10
7.3.2	Claims fees payable before the grant of the European patent	X-11
<b>8.</b>	<b>No deferred payment of fees, no legal aid, no discretion</b>	<b>X-11</b>
<b>9.</b>	<b>Reduction of fees</b>	<b>X-11</b>
9.1	General	X-11
9.2	Reduction under the language arrangements	X-11
9.2.1	Conditions	X-11
9.2.2	Reduction of the filing fee	X-13
9.2.3	Reduction of the examination fee	X-14



9.3	Special reductions	X-14
9.3.1	Reduction of the search fee for a supplementary European search	X-14
9.3.2	Reduction of the examination fee where the international preliminary examination report is being drawn up by the EPO	X-15
9.3.3	Reduction of the fees for the international search and international preliminary examination of an international application	X-15
<b>10.</b>	<b>Refund of fees</b>	<b>X-15</b>
10.1	General remarks	X-15
10.1.1	Fee payments lacking a legal basis	X-15
10.1.2	Fee payments which are not valid	X-16
10.1.3	Insignificant amounts	X-16
10.2	Special refunds	X-16
10.2.1	Refund of the search fee	X-16
10.2.2	Refund of the further search fee	X-17
10.2.3	Refund of the international search fee	X-17
10.2.4	Refund of the examination fee	X-17
10.2.5	Refund of the international preliminary examination fee	X-17
10.2.6	Refund pursuant to Rule 37(2)	X-17
10.2.7	Refund of the fee for grant and publishing	X-17
10.3	Method of refund	X-18
10.4	Person to whom refund is payable	X-18
10.5	Re-allocation instead of refund	X-18
<b>11.</b>	<b>Crediting of fees under Rule 71a(5)</b>	<b>X-18</b>
11.1	Crediting of the fee for grant and publishing	X-19
11.2	Crediting of claims fees	X-19
11.3	Separate crediting of the fee for grant and publishing and claims fees	X-20
11.4	Further processing fee and crediting of fees	X-20
	<b>Chapter XI – Inspection of files; communication of information contained in files; consultation of the Register of European Patents; issuance of certified copies</b>	<b>XI-1</b>
<b>1.</b>	<b>General</b>	<b>XI-1</b>

---

<b>2.</b>	<b>Inspection of files</b>	<b>XI-1</b>
2.1	Extent of file inspection	XI-1
2.2	Procedure for file inspection	XI-2
2.3	Restrictions to file inspection	XI-3
2.4	Confidentiality of the request	XI-3
2.5	File inspection before publication of the application	XI-3
2.6	Publication of bibliographic data before publication of the application	XI-4
<b>3.</b>	<b>Communication of information from the files</b>	<b>XI-4</b>
<b>4.</b>	<b>Consultation of the European Patent Register</b>	<b>XI-4</b>
<b>5.</b>	<b>Certified copies</b>	<b>XI-4</b>
<b>6.</b>	<b>Priority documents issued by the EPO</b>	<b>XI-5</b>

## Chapter I – Introduction

### 1. Overview

This Part A of the Guidelines deals with the following:

- (i) the requirements and procedure relevant to the examination as to formalities of European patent applications (Chapters A-II to VI);
- (ii) formalities matters of a more general nature which can arise during the application procedure or the post-grant stage (Chapters A-VII and VIII),
- (iii) the presentation and execution of drawings and figurative representations accompanying a European patent application (Chapter A-IX);
- (iv) fee questions (Chapter A-X);
- (v) inspection of files, communication of information contained in files, consultation of the Register of European Patents and issuance of certified copies (Chapter A-XI).

### 2. Responsibility for formalities examination

The matters covered by this Part A are directed to the formalities staff of the EPO whether they be in The Hague, Munich or Berlin. They are directed primarily to the Receiving Section which is specifically responsible under the EPC for ensuring that the formal requirements for European patent applications are adhered to. Once the application is transferred to the Examining Division, the latter accepts responsibility for the formalities of the application, although it should be understood that reference to the Examining Division is intended to cover the formalities officer to whom this work is entrusted (see the Decision of the President of the EPO dated 12 December 2013, OJ EPO 2014, A6).

*Rule 10*  
*Rule 11(3)*

### 3. Purpose of Part A

The formalities staff should note that this Part A of the Guidelines is intended to provide them with the knowledge and background which it is felt will assist them in carrying out their functions in a uniform and expeditious manner. It does not, however, provide authority for ignoring the provisions of the EPC and in that regard specific attention is directed to paragraph 3 of the General Part of the Guidelines.

### 4. Other Parts relating to formalities

It is not the intention that the formalities staff should concern themselves with only this Part A of the Guidelines. It is expected that they will have to refer frequently to the other Parts and in particular Part E.





## Chapter II – Filing of applications and examination on filing

### 1. Where and how applications may be filed

#### 1.1 Filing of applications by delivery by hand or by post

European patent applications may be filed in writing, by delivery by hand, by post or by technical means of communication (see A-II, 1.2 and 1.3) at the EPO's filing offices in Munich, The Hague or Berlin. The EPO's sub-office in Vienna is not a filing office.

*Art. 75(1)*

*Rule 35(1)*

*Rule 2(1)*

The opening hours of the filing offices of the EPO were published in the Notice from the EPO dated 12 July 2007, Special edition No. 3, OJ EPO 2007, A.2. Dates on which at least one of the filing offices of the EPO is not open to receive documents are likewise announced at regular intervals in the Official Journal of the EPO (see also E-VII, 1.4).

The EPO filing offices in Berlin and Munich are equipped with automated mail-boxes, which may be used at any time. The automated mail-box facility is not currently available at the filing office at The Hague. Outside office hours documents may be handed in to the porter.

European patent applications (with the exception of divisional applications, see A-IV, 1.3.1, and applications according to Art. 61(1)(b), see A-IV, 2.5) may also be filed at the central industrial property office or other competent authority of a Contracting State if the national law of that State so allows (see A-II, 1.7).

#### 1.2 Filing of applications by fax

Applications may also be filed by fax with the filing offices of the EPO or with the competent national authorities of those Contracting States which so permit, namely – at present – Austria (AT), Belgium (BE), Bulgaria (BG), Czech Republic (CZ), Denmark (DK), Finland (FI), France (FR), Germany (DE), Greece (GR), Iceland (IS), Ireland (IE), Liechtenstein (LI), Luxembourg (LU), Monaco (MC), Norway (NO), Poland (PL), Portugal (PT), San Marino (SM), Slovakia (SK), Slovenia (SI), Spain (ES), Sweden (SE), Switzerland (CH) and United Kingdom (GB). For further details, see the latest version of the brochure "National Law relating to the EPC".

*Rule 2(1)*

Where a document transmitted using such technical means is illegible or incomplete, the document is to be treated as not having been received to the extent that it is illegible or that the attempted transmission failed and the sender must be notified as soon as possible (see the Decision of the President of the EPO dated 12 July 2007, Special edition No. 3, OJ EPO 2007, A.3).

If a European patent application is filed by fax, a written confirmation is required only where the documents are of inferior quality. In this case,

the EPO will invite the applicant to supply such documents within a period of two months (Rule 2(1)). If the applicant fails to comply with this invitation in due time, the European patent application will be refused. To prevent duplication of files, applicants are asked to indicate on the paper version of the application documents the application number or fax date and the name of the authority with which the documents were filed and to make it clear that these documents represent "confirmation of an application filed by fax".

### 1.3 Filing of applications in electronic form

European patent applications and international (PCT) applications may be filed with the EPO in electronic form either **online** or on **electronic data carriers** (see the Decision of the President of the EPO dated 26 February 2009, OJ EPO 2009, 182). At present, the data carriers permitted are CD-R as per ISO 9660 and DVD-R or DVD+R (see the Decision of the President of the EPO dated 12 July 2007, Special edition No. 3, OJ EPO 2007, A.5). Documents making up a European or an international patent application in electronic form must be prepared using either the EPO Online Filing software or the PaTrAS software, both of which include the Request for Grant Form, unless the use of other software is permitted (see Art. 5 of the Decision of the President dated 26 February 2009, OJ EPO 2009, 182, Art. 2 of the Decision of the President of the EPO dated 12 July 2007, Special edition No. 3, OJ EPO 2007, A.5, and the Notice from the EPO dated 12 July 2007, Special edition No. 3, OJ EPO 2007, A.6).

Other documents may also be filed electronically in grant, opposition, limitation, revocation and appeal proceedings (see the Decision of the President of the EPO dated 26 February 2009, OJ EPO 2009, 182, with particular reference to Art. 8(2) thereof, which sets out the requirement for confirmation of the authenticity of documents filed in appeal proceedings by means of an enhanced electronic signature, see also A-VIII, 2.5).

European patent applications may also be filed in electronic form with the competent national authorities of those Contracting States which so permit.

### 1.4 Filing of applications by other means

As of 1 January 2003 European patent applications may no longer be filed with the EPO on **diskette** accompanied by a paper version prepared by means of the **EP-EASY** software (see the Notice from the EPO dated 1 October 2002, OJ EPO 2002, 515). This applies also to the filing of European patent applications with the filing offices of Belgium (BE), Finland (FI), France (FR), Sweden (SE), Switzerland (CH) and the United Kingdom (GB).

The filing of European patent applications by other means such as **e-mail** is at present not allowed (see also the Notice dated 12 September 2000, OJ EPO 2000, 458).

## 1.5 Subsequent filing of documents

For the subsequent filing of documents, see A-VIII, 2.5 and A-II, 1.3, second paragraph.

## 1.6 Debit orders for deposit accounts held with the EPO

European patent applications and international (PCT) applications may be accompanied by a debit order for the fees due. To avoid the risk of payment being debited twice where a debit order is sent by fax, the original should not be filed subsequently (see points 6.2, 6.6 and 6.7 of the Arrangements for deposit accounts, Supplementary publication 4, OJ EPO 2014, 5). For the abolition of payments by cheque, see A-X, 2.

*Points 6.2, 6.6 and 6.7 ADA*

## 1.7 Forwarding of applications

The central industrial property office of a Contracting State is obliged to forward to the EPO, in the shortest time compatible with national law concerning the secrecy of inventions, applications filed (see A-II, 3.2) with that office or with other competent authorities in that State (for debit order enclosures, see A-II, 1.6).

*Art. 77(1)  
Rule 37(1)*

A time limit of six weeks after filing is specified for the onward transmission to the EPO of applications the subject-matter of which is obviously not liable to secrecy, this time limit being extended to four months or, where priority has been claimed, to fourteen months after the date of priority, for applications which require further examination as to their liability to secrecy. It should be noted, however, that an application received outside the specified time limits, either six weeks or four months, must be processed provided the application is received in Munich, The Hague or Berlin before the end of the fourteenth month after filing or, where appropriate, after the date of priority. Applications received outside this last mentioned time limit are deemed to be withdrawn. Re-establishment of rights and further processing in respect of the period under Rule 37(2) are not possible, since the loss of rights does not result from a failure of the applicant to observe a time limit (see J 3/80), but a request for conversion under Art. 135(1)(a) may be filed (see A-IV, 6).

*Art. 77(3)  
Rule 37(2)  
Art. 135(1)(a)*

If the time limit referred to in Rule 37(2) expires on a day on which there is an interruption or subsequent dislocation in the delivery or transmission of mail within the meaning of Rule 134(2), the time limit will extend to the first day following the end of the period of interruption or dislocation.

*Rule 134(2)*

## 1.8 Application numbering systems

### 1.8.1 Applications filed before 1 January 2002

For applications filed **before** 1 January 2002, the following numbering system applies:

The application number consists of nine digits. The first two digits (from left to right) of the application number indicate the filing year. The last

(ninth) digit is a check digit. The third digit or third and fourth digits of the application number indicate(s) the place of filing.

The remaining digits are used for consecutively numbering the applications in the order in which they come in at the place of filing.

International applications filed under the Patent Cooperation Treaty (PCT) and designating "EP" (Euro-PCT applications) receive the digit "7", "8" or "9" as the third digit.

### **1.8.2 Applications filed on or after 1 January 2002**

For applications filed **on or after** 1 January 2002, the following numbering system applies:

The application number consists of nine digits. The first two digits (from left to right) of the application number indicate the filing year. The last digit is a check digit. The remaining six digits in between are used for consecutively numbering the applications in the order in which they arrive at the place of filing, starting from a lowest number within a specific range of six-digit numbers. The specific range reflects the place of filing. Where applicable, the range is subdivided into two ranges in order to distinguish between paper and online filings.

The above also applies to international applications designating "EP" (Euro-PCT applications), albeit that for these applications a dedicated range for the above-mentioned six-digit number within the application number is used, which does not reflect the place of filing.

A list of the number ranges introduced in 2002, along with, where appropriate, the corresponding places of filing, is published in OJ EPO 2001, 465.

## **2. Persons entitled to file an application**

*Art. 58*

A European patent application may be filed by any natural or legal person, or any body equivalent to a legal person by virtue of the law governing it.

*Art. 60(3)*

For the purposes of proceedings before the EPO, the applicant shall be deemed to be entitled to exercise the right to the European patent.

*Art. 59*

*Art. 118*

The application may be in the name of one person or several persons may be named as joint applicants. The application may also be filed by two or more applicants designating different Contracting States. It may arise that a first applicant designates one group of Contracting States and a second designates a different group of Contracting States, while both applicants jointly designate a third group of Contracting States. If the applicants for a patent are not the same for different Contracting States they will be regarded as joint applicants in proceedings before the EPO (see A-III, 4.2.1 and 11.1 as to when and under what circumstances the matter dealt with in this paragraph need be considered during the formalities examination).

If it is adjudged that a person other than the applicant is entitled to the grant of a European patent that person has the option of prosecuting the application as his own application in place of the applicant (see A-IV, 2).

*Art. 61(1)*

### **3. Procedure on filing**

#### **3.1 Receipt; confirmation**

The authority with which the application is filed – either the EPO (Munich, The Hague or Berlin) or the competent national authority – must mark the documents making up the application with the date of receipt and issue a receipt to the applicant (for the date of receipt of applications received by fax see Art. 5 of the Decision of the President of the EPO dated 12 July 2007, Special edition No. 3, OJ EPO 2007, A.3). The receipt must be issued without delay and include at least the application number, the nature and number of the documents and the date of their receipt. The receipt should also include the applicant's or representative's file reference number or any other information which would be helpful in identifying the applicant. The receipt of European patent applications filed online will be acknowledged electronically during the submission session. Where it becomes apparent that such acknowledgment was not successfully transmitted, the authority with which the application is filed will promptly transmit the acknowledgment by other means where the necessary indications furnished to it so permit (see Art. 10 of the Decision of the President of the EPO dated 26 February 2009, OJ EPO 2009, 182). On request, the EPO also provides confirmation by fax of the receipt of documents filed with it (see Art. 8 of the Decision of the President of the EPO dated 12 July 2007, Special edition No. 3, OJ EPO 2007, A.3). To ensure despatch of the receipt immediately after the documents are received:

*Rule 35(2)*

- the request for the issue of a receipt by fax must be transmitted at the same time as the documents filed;
- the postal or fax address to which the receipt is to be sent must be stated; and
- evidence of the payment of the prescribed administrative fee or a debit order must be enclosed (only in case of acknowledgment by fax).

The amount of the administrative fee is regularly indicated in the Official Journal.

#### **3.2 Filing with a competent national authority**

If the application is filed with a competent national authority, that authority must without delay inform the EPO of receipt of the documents making up the application and indicate the nature and date of receipt of the documents, the application number and any priority date claimed. It is recommended that the competent national authority should indicate as well the applicant's or representative's reference

*Rule 35(3)*

number where such has been indicated. In practice, the above-mentioned information is provided to the EPO by the forwarding of the application itself, unless national security checks by the national office delay the forwarding of the application, in which case a separate notice is sent by that office to the EPO.

*Rule 35(4)* When the EPO has received an application which has been forwarded by the central industrial property office of a Contracting State, it notifies the applicant, indicating the date of receipt at the EPO (see OJ EPO 1990, 306). Once this communication has been received, all further documents relating to the application must be sent directly to the EPO.

*Art. 77(3)*  
*Rule 37(2)*  
*Rule 112(1)* Where an application is not received at the EPO from the central industrial property office of a Contracting State before the end of the fourteenth month after filing or, if priority has been claimed, after the date of priority and is consequently deemed to be withdrawn (see A-II, 1.7), the applicant must be notified accordingly; all fees must be refunded, including any surcharges paid and any fees paid in advance of their due date.

#### **4. Examination on filing**

##### **4.1 Minimum requirements for according a date of filing**

*Art. 90(1)*  
*Rule 10(1)* The EPO examines applications to determine whether they meet the minimum requirements for according a date of filing (since this occurs before the Examining Division assumes responsibility, this check is carried out by the Receiving Section). These requirements are satisfied where the documents filed contain:

- Rule 40(1)(a)* (i) an indication that a European patent is sought;
- Rule 40(1)(b)* (ii) information identifying the applicant or allowing the applicant to be contacted; and
- Rule 40(1)(c)* (iii) a description or reference to a single previous application.

It is not necessary that the applicant provide any claims in order to obtain a date of filing. If the application is filed without claims, but satisfies all requirements for obtaining a date of filing, the applicant will be requested to provide at least one claim later according to Rules 57(c) and 58 (see A-III, 15).

Where the description is filed by reference to a previously filed application (see A-II, 4.1.3.1), the reference must contain the following information in order for the application to qualify for a filing date according to Rule 40(2):

- (i) the filing date of the previous application
- (ii) its file number

- (iii) the office where it was filed
- (iv) an indication that this reference replaces the description and any drawings.

To be accorded a date of filing, these documents do not have to meet any particular requirements as to form or presentation. It is essential, however, that the documents be sufficiently legible to enable the information to be discerned. *Rule 1*

#### **4.1.1 Indication that a European patent is sought**

Use of the prescribed Request for Grant form or the EPO Online Filing software best provides "the indication that a patent is sought" as referred to in A-II, 4.1(i) (see also A-III, 4).

#### **4.1.2 Information concerning the applicant**

For the purposes of establishing a date of filing, information must be supplied which:

- (i) identifies the applicant or
- (ii) allows the applicant to be contacted.

If there are multiple applicants, for the purposes of establishing a filing date, the above information only has to be supplied concerning one of them. Any kind of information which allows the applicant to be contacted will be considered to fulfil requirement (ii), in particular:

- (a) the name and address of the applicant's representative
- (b) a fax number
- (c) a PO box number.

If the information supplied is sufficient to establish a date of filing but is not sufficient for the EPO to establish whether or not the applicant requires a representative according to Art. 133(2), the procedure outlined in A-III, 16 will be followed.

In deciding whether or not the above information concerning the applicant satisfies the above requirements, the EPO will take into account all data contained in the documents filed (see J 25/86). Objection should not be raised at this stage with regard to the status of the applicant or his entitlement to apply, or where, in the case of joint applicants, there is doubt as to the Contracting States designated by the individual applicants.

#### **4.1.3 Description**

The contents of the description do not require close scrutiny – it is sufficient to identify a document (or documents) which appear(s) to

include a description. If instead of filing a description, the applicant has filed a reference to a previously filed application, see A-II, 4.1.3.1.

#### **4.1.3.1 Reference to a previously filed application**

Instead of filing application documents, the applicant can file a reference to a previously filed application according to Rule 40(1)(c). The previously filed application relied on for the reference does not need to be claimed as priority.

*Rule 40(2)*

##### *Details required on the date of filing*

According to Rule 40(2), in order to qualify for a date of filing, the applicant must indicate the following details on the filing date:

- (i) the filing date of the previous application
- (ii) its file number
- (iii) the office where it was filed
- (iv) an indication that this reference replaces the description and any drawings.

The previous application referred to may also be an application for a utility model.

*Rule 40(3)*

*Rule 53(2)*

##### *Copy of the previously filed application*

The applicant must supply a certified copy of the previously filed application within two months of the filing date (Rule 40(3)). However, according to Rule 40(3), last sentence, this requirement is dispensed with where the previously filed application is already available to the EPO under the conditions specified by the President. According to the Notice from the EPO dated 14 September 2009, OJ EPO 2009, 486, a certified copy does not need to be filed where the previously filed application is a European application or an international one filed with the EPO as receiving office under the PCT. In all other cases, a certified copy of the previously filed application to which reference is made must be filed within the time limit under Rule 40(3).

Where the previously filed application referred to is the claimed priority, only one certified copy needs to be filed in order to satisfy both the requirements relating to the filing date (Rule 40(3)) and those relating to the priority claim (Rule 53(1), see A-III, 6.7).

For divisional applications filed by reference to the parent application (see A-IV, 1.3.1), if the parent application is a European application or an international one filed with the EPO as receiving office, a copy will automatically be included in the file of the divisional by the EPO.



### *Translation of the previously filed application*

*Rule 40(3)*

If the previously filed application is not in an official language of the EPO, the applicant must also file a translation into one of those languages within two months of the filing date (Rule 40(3)). If the translation of the previously filed application is already available to the EPO, a copy of this will be included in the file free of charge and the applicant will not need to file it (Rule 40(3)).

Note that where the previously filed application is in a language according to Art. 14(4) (an official language of a Contracting State to the EPC), the application may qualify for a reduction of the filing fee, provided that the applicant is entitled according to Rule 6(3) in conjunction with Rule 6(4) to (7) (see A-X, 9.2.1 and 9.2.2). The reduction applies even in cases where the description is filed by reference to a previously filed application according to Rule 40(1)(c), where the previously filed application is in a language specified in Art. 14(4) but the claims are filed after the date of the filing in accordance with Rule 57(c) and Rule 58 and in an official language of the EPO. This is because the essential element for establishing a filing date (the provision of a description, see Rule 40(1)(c)) has been provided in a language giving rise to the entitlement to the reduction (see G 6/91, *mutatis mutandis*).

### *The claims*

The applicant also has the option of indicating that he wishes the claims of the previously filed application to take the place of claims in the application as filed. Such an indication must be made on the date of filing, preferably by crossing the appropriate box in the Request for Grant (Form 1001). If this indication is made, then the claims of the previously filed application will form the basis for the search, and will satisfy the requirement of Rule 57(c), so that an invitation under Rule 58 to file claims later will not be issued.

If the applicant does not refer to the claims of the previously filed application, but refers only to the description and any drawings thereof, he may at the same time as filing the reference (i.e. on the date of filing), file a set of claims. If the applicant does not do so, he will be invited by the EPO to file claims (see A-III, 15).

#### **4.1.4 Deficiencies**

If the EPO (Receiving Section) notes either of the following deficiencies:

*Art. 90(1) and (2)*  
*Rule 55*

- Rule 40(1)(a) - no indication that a European patent is sought, or
- Rule 40(1)(c) - no description or reference to an earlier application,

either of which prevents the application being accorded a date of filing, it communicates this to the applicant and invites him to remedy it within a non-extendable period of two months of notification of the communication. If the applicant does not remedy the deficiency in due time he is informed that the application will not be dealt with as a European application. Any fees which have been paid are refunded.

In the event that the information concerning the applicant is missing or does not enable the EPO to contact him (a deficiency according to Rule 40(1)(b)), no such communication is sent. However, if the applicant corrects this deficiency of his own motion within two months of the date of receipt of the original documents, then the date of filing is the date on which all requirements of Rule 40 are met. If the requirements of Rule 40 are not met at the end of this period, the application will not be dealt with as a European application and the applicant will have to re-file all documents relating to the purported European application.

*Filing by reference to a previous application*

Where the application is filed by reference to a previously filed application and the EPO (Receiving Section) notes that any of the following information is missing:

- (i) the filing date of the previous application
- (ii) its file number
- (iii) the office where it was filed
- (iv) an indication that this reference replaces the description and any drawings

then it proceeds as above and invites the applicant to remedy the deficiency within a two-month time limit (Rule 55). If the applicant does not remedy the deficiencies in due time, the application is not treated as a European application.

If the applicant does not provide the certified copy of the previously filed application within two months of filing the application (Rule 40(3)) and this is not already available to the EPO (see A-II, 4.1.3.1), then he will also be sent a communication according to Rule 55, requesting him to file it within a non-extendable period of two months. If the applicant does not provide the certified copy in due time, the application is also not treated as a European application. Where a translation of the application is also required and this is not provided within the above time limit, the procedure given in A-III, 14 is followed. The filing date is unaffected by a missing translation.

#### **4.1.5 Date of filing**

The date of filing accorded to the application is the date the application meets the requirements of A-II, 4.1 and is either:

- (i) the date of receipt at the EPO or competent national authority; or
- (ii) the date, not later than the two-month period referred to in A-II, 4.1.4, on which the applicant rectifies any deficiencies. In the latter case, the applicant is informed of the date of filing accorded to his application.

Case (ii) is subject to one exception. Where the application is filed by reference to a previously filed application and the applicant fails to file the certified copy of the previously filed application within two months of the filing date as required by Rule 40(3), he is invited to file it within a period of two months from a communication according to Rule 55. If the applicant files the certified copy within this two-month period, the application maintains its original date of filing, provided that all other requirements for acquiring a date of filing have been met.

The date of filing may also change in cases where the applicant inserts parts of the description or drawings after the date of filing (see A-II, 5).

### **5. Late filing of drawings or parts of the description**

#### **5.1 Late filing of drawings or parts of the description - on invitation**

The application is examined on filing to check that it is entitled to a date of filing. If during this check the EPO notes that parts of the description, or drawings appear to be missing, it shall invite the applicant to file the missing parts within a time limit of two months from the invitation. If the applicant does not reply to this invitation in time, then all references to the missing parts are deemed to be deleted.

*Art. 90(1)*  
*Rule 56(1)*  
*Rule 56(4)(a)*

#### **5.2 Late filing of drawings or parts of the description - without invitation**

The applicant may also file missing parts of the description, or drawings of his own motion (without being invited to do so by the EPO) within two months of the date of filing. If the applicant does not file the missing parts within this period, all references to the missing parts are deemed to be deleted. However, if the applicant is invited by the EPO to file the missing parts, the period under Rule 56(1) takes precedence (see A-II, 5.1).

*Rule 56(2)*  
*Rule 56(4)(a)*

If, within two months of the original date of filing, the applicant notices that he has neglected to include drawings and/or parts of the description in the application as originally filed, it is advisable to file these as soon as possible of his own motion according to Rule 56(2), since if the EPO does not invite him to file the missing parts, then any possibility for him to file them later ends two months after the original date of filing.

### 5.3 The filing date changes

*Rule 56(2)*

If the applicant files missing parts of the description, or drawings, in accordance with the procedures explained in A-II, 5.1 or 5.2, then the date of filing changes to the date on which the missing parts are received at the EPO. The applicant is informed of the new date of filing. This is subject to the exception explained in A-II, 5.4.

A "drawing" means a single numbered figure. Only whole figures will be accepted according to Rule 56, even where only a part of the original figure was missing.

### 5.4 Missing parts based on priority, no change in filing date

*Rule 56(3)*

If the applicant files missing parts of the description, or drawings, after the date of filing in accordance with the procedures explained in A-II, 5.1 or 5.2, the date of filing does not change, provided that the following criteria are satisfied:

- (i) the missing parts are filed within the applicable time limit\*
- (ii) the application claims priority (see A-II, 5.4.1)
- (iii) the applicant requests that the late-filed parts be based on the claimed priority in order to avoid a change in the date of filing, and does so within the applicable time limit\* (see A-II, 5.4.1)
- (iv) the late-filed parts of the description, or drawings, are completely contained in the claimed priority application (see A-II, 5.4.2)
- (v) the applicant files a copy of the priority application within the applicable time limit\*, unless such copy is already available to the EPO under Rule 53(2) (see A-II, 5.4.3)
- (vi) where the priority document is not in an official language of the EPO, the applicant files a translation into one of these languages within the applicable time limit\*, unless such a translation is already available to the EPO under Rule 53(3) (see A-II, 5.4.4)
- (vii) the applicant indicates where in the priority document and, if applicable, where in its translation, the late-filed missing parts of the description, or drawings, are completely contained, and does so within the applicable time limit\* (see A-II, 5.4.2).

*Rule 56(3)(a)*

*Rule 56(3)(b)*

*Rule 56(3)(c)*

\*For the applicable time limit see whichever of A-II, 5.1 or 5.2 applies.

Where criterion (i) is not satisfied, the late-filing of those parts is deemed not to have been made and all references thereto in the application are deemed to be deleted under Rule 56(4)(a) (see A-II, 5.1 and 5.2). In this case the filing date does not change, but the late filed parts are not introduced into the application either.

If the request according to Rule 56(3) does not comply with one or more of the above requirements (ii)-(iv), then according to Rule 56(2) the date of filing will change to the date on which the EPO received the late-filed missing parts of the application. The EPO will send the applicant a communication informing him of this according to Rule 56(2). *Rule 56(2)*

If the request according to Rule 56(3) does not comply with one or more of the above requirements (v)-(vii), then according to Rule 56(5) the date of filing will change to the date on which the EPO received the late-filed missing parts of the application. The EPO will send the applicant a communication informing him of this according to Rule 56(5). *Rule 56(5)*

#### **5.4.1 Late-filed missing parts and the priority claim**

In the context of a request under Rule 56(3) the EPO will check that the requirements for the priority claim are met (see A-III, 6).

Where the applicant files a request under Rule 56(3) (see A-II, 5.4), the priority claim in question must have been in existence no later than the filing of this request. To this end, the applicant can file a simultaneous request, contained in one single submission:

- (i) to insert a new priority claim not present when the application was filed according to Rule 52(2), and
- (ii) to base late-filed missing parts of the description, or drawings, on that priority claim according to Rule 56(3)

This is subject to the proviso that the above simultaneous request respects both the time limit according to Rule 52(2) for insertion of a new priority claim (see A-III, 6.5.1) and the applicable time limit for making the request according to Rule 56(3) (see whichever of A-II, 5.1 or 5.2 applies). If this is the case, then the requirement under Rule 56(3) that priority be claimed is met (see A-II, 5.4(ii)).

Alternatively, the applicant may file submission (i) earlier (again, provided that it is filed within the time limit according to Rule 52(2)) and then subsequently file submission (ii) (again, provided that it complies with the applicable time limit). However, it is not possible to file request (ii) before request (i), because in this case request (ii) would be filed at a time when there is no priority claim, and it would not meet the requirements of Rule 56(3).

#### **5.4.2 The missing parts are completely contained in the claimed priority**

In cases where no translation of the priority is required and the application and priority are in the same official language, the requirement that the late-filed parts of the application are "completely contained" in the claimed priority is met only if the parts of the claimed priority identified by the applicant according to Rule 56(3)(c) contain

the same drawings, with the same annotations or for late-filed parts of the description, contain the same text.

If a translation of the claimed priority is required, then the requirement that the late-filed parts of the application are "completely contained" in the claimed priority is met only if the parts of the translation of the claimed priority identified by the applicant according to Rule 56(3)(c) contain the same drawings, with the same annotations or, for late-filed-parts of the description, contain the same text.

#### **5.4.3 Copy of the claimed priority**

The copy of the priority application which is required for the request according to Rule 56(3) does not need to be certified. However, if the applicant does provide a certified copy in the context of his request according to Rule 56(3), he will not need to provide it again in the context of his priority claim according to Rule 53(1).

Where a copy of the claimed priority is already available to the EPO under Rule 53(2) in accordance with the conditions laid down by the President, the applicant does not need to file it at all. Currently, this applies where the claimed priority is one of the following (see the Decision of the President of the EPO dated 9 August 2012, OJ EPO 2012, 492):

- (a) a European application
- (b) an International application filed with the EPO as receiving Office
- (c) a Chinese patent or utility model application
- (d) a Japanese patent or utility model application
- (e) a Korean patent or utility model application
- (f) a US patent application or provisional patent application subject to the document exchange agreement with the USPTO (see OJ EPO 2007, 473, and A-III, 6.7).

#### **5.4.4 Translation of the priority**

Where a translation of the claimed priority is already available to the EPO under Rule 53(2), the applicant does not need to file it.

In cases where the claimed priority is in an official language of the EPO and the European application is in a different official language of the EPO, there is no requirement for the applicant to file a translation of the priority according to Rule 56(3)(b). However, since the language of the priority and of the European application differ, the requirement that the newly introduced drawings (if they contain annotations) or parts of the description are "completely contained" in the priority (Rule 56(3)) is not

met. This can be overcome by the applicant's supplying within the applicable time limit (see whichever of A-II, 5.1 or 5.2 applies), either:

- (i) a translation from the official language of the priority into the official language of the European application of those parts of the priority identified by the applicant as completely containing the missing parts of the description, or drawings (Rule 56(3)(c)), or
- (ii) a declaration indicating that the late-filed missing parts of the description, or drawings, are an exact translation of the parts of the priority identified by him according to Rule 56(3)(c).

The entire priority document does not need to be translated, since this translation is required to satisfy the "completely contained" requirement of Rule 56(3), not the translation requirement of Rule 56(3)(b).

### **5.5 Withdrawal of late-filed missing drawings/parts of the description**

Where the applicant files missing parts of the description, or drawings, and makes no request to base these late-filed parts on a claimed priority, he is informed of the new date of filing in a communication from the EPO (see A-II, 5.3). Within one month of this communication, the applicant may withdraw the late-filed parts of the application and if he does so, the re-dating of the application is deemed not to have been made and all references to the missing parts of the description, or drawings, are deemed to be deleted. The EPO will inform the applicant of this.

*Rule 56(2) and (4)*

Where the applicant files missing parts of the description, or drawings, and requests that these late-filed parts be based on a claimed priority, but the requirements of Rule 56(3) are not met within the applicable time limit, the date of filing changes to the date on which the late-filed parts of the application are received at the EPO (Rule 56(2) or (5)). The applicant is informed of the new date of filing in a communication from the EPO. Within one month of this communication, the applicant may withdraw the late-filed parts of the application (Rule 56(6)); if he does so, the re-dating of the application is deemed not to have been made and all references to the missing parts of the description, or drawings, are deemed to be deleted (Rule 56(4)). The EPO will inform the applicant of this.

*Rule 56(2), (4) and (5)*

Where references to a missing figure, e.g. "see Fig. 4", are deemed to be deleted, then reference signs cited in the context of that reference are also deemed to be deleted, although any technical information in the reference which is still technically meaningful without the reference may be retained: e.g. "see Fig. 4, a distillation column (1), provided with a condenser (2)" becomes "a distillation column provided with a condenser".

If the late-filed missing parts of the application do not satisfy the physical requirements of Rule 49, the EPO will not request the applicant to correct this deficiency according to Rule 58, until the one-month period for withdrawing them has expired without the applicant having withdrawn them (see A-III 3.2.2).



## Chapter III – Examination of formal requirements

### 1. General

#### 1.1 Formal requirements

==  
=+ The formal requirements that an application has to meet are the *Art. 90(3)*  
subject of an examination by the Receiving Section. These *Rule 57*  
requirements relate to the following:

- (i) representation;
- (ii) physical requirements of the application;
- (iii) abstract;
- (iv) request for grant;
- (v) claim to priority;
- (vi) designation of inventor;
- (vii) translations, where required;
- (viii) the presence of at least one claim;
- (ix) filing and search fees

#### 1.2 Further checks

In addition to the above, it is necessary for the Receiving Section to:

- |  
== (i) carry out a preliminary check of the description and claims in *Rule 41(2)(b)*  
order to ensure that the title of the invention, which will appear in  
the published application, is in general accord with the  
requirements of Rule 41(2)(b)
- | (ii) check whether any claims fees due have been paid (see also *Rule 45(1) and (2)*  
A-III, 9)
- | (iii) check whether the certificate of exhibition under Rule 25 has *Art. 55(1)(b)*  
been filed where the invention has been displayed under *Rule 25*  
Art. 55(1)(b) (see also A-IV, 3)
- | (iv) check whether in the case of European patent applications *Rule 31*  
relating to biological material the information pursuant to  
Rule 31(1)(c) and (d) is complete (see also A-IV, 4)

- Rule 30* (v) check whether in the case of an application with nucleotide and/or amino acid sequences a prescribed sequence listing has also been filed (see also A-IV, 5, and the Decision of the President of the EPO dated 28 April 2011, OJ EPO 2011, 372 and the Notice from the EPO dated 18 October 2013, OJ EPO 2013, 542).

The requirements of the above paragraphs and the procedure to be followed when the requirements are not met are considered in subsequent sections of this Chapter.

## 2. Representation

### 2.1 Requirements

The formalities officer must ensure that the requirements with regard to representation as set out in A-VIII, 1 are met. The main points to be considered are:

- Art. 133(2)* (i) the necessity for applicants who have neither a residence nor principal place of business in a Contracting State to be represented by an authorised professional representative or by an authorised legal practitioner fulfilling the requirements of Art. 134(8);
- Art. 133(3)* (ii) that, where an applicant who is resident in or has his principal place of business in a Contracting State is represented by an employee, the employee is authorised; and
- Rule 152* (iii) that the authorisation, if any is required (see A-VIII, 1.5 and the Decision of the President of the EPO dated 12 July 2007, Special edition No. 3, OJ EPO 2007, L.1), is in order, duly signed (see A-VIII, 3.2 and 3.4) and is filed in due time.

### 2.2 Non-compliance

The effect of non-compliance with the provisions with regard to representation and the action to be taken by the formalities officer in dealing with any deficiency are considered in A-III, 16.

## 3. Physical requirements

### 3.1 General remarks

- Art. 90(3)* Every application that is subject to formal examination is examined for compliance with the requirements as to form set out below. Non-compliance with the requirements is considered in A-III, 16.

### 3.2 Documents making up the application, replacement documents, translations

It is the responsibility of the Receiving Section to ensure that the documents making up the application, i.e. request, description, claims, drawings and abstract, meet the requirements of Rule 49(2) to (9) and (12) and, with regard to drawings, the requirements of Rule 46, to the

extent necessary for the purpose of a reasonably uniform publication of the application under Rule 68(1). The Receiving Section should therefore not draw the attention of the applicant to any deficiencies related to the content of the application, namely those under Rule 46(2)(i) or (j) or 49(9).

With regard to those requirements in relation to which some technical knowledge may be needed, such as those of Rule 46(2)(f) and (h), the Receiving Section should, in case of doubt, consult and take the advice of the Search Division. The Receiving Section should also consider taking action when the Search Division draws its attention to a deficiency which it had overlooked. It should be noted that, in accordance with Rule 46(3), flow sheets and diagrams are to be considered as drawings.

Once the Examining Division assumes responsibility for the application, it also becomes responsible for formal matters. It should pay particular attention to the more technical requirements of Rule 46 and Rule 49, including in particular the above-mentioned requirements under Rule 46(2)(i) and (j) and Rule 49(9) and those laid down in Rule 49(10) and (11).

*Rule 10*  
*Art. 94(1)*  
*Rule 46*

Replacement documents, including the amendment of granted patents (Rule 86), and translations in an official language of documents filed under the provisions of Art. 14(2) or (4) are subject to the same requirements as the documents making up the application. As a consequence, they must be typed or printed. Submissions containing handwritten amendments to application or patent specification documents are formally deficient and need to be corrected (see OJ EPO 2013, 603).

*Rule 1*  
*Rule 49(2)*  
*Rule 50(1) and (2)*  
*Rule 86*

If the requirements of Rules 46 and 49 are not met, the applicant is invited to remedy this deficiency within a two-month period (Rule 58 and Rule 50(1)). If this deficiency is not remedied in due time, the application is refused (Art. 90(5)). In examination proceedings this task is carried out by the formalities officer on behalf of the Examining Division (see the Decision of the President of the EPO dated 12 December 2013, OJ EPO 2014, A6).

In the event of deficiencies under Rule 30, the Receiving Section must invite the applicant to remedy them within a two-month period. If this deficiency is not remedied in due time, the application is refused by the Receiving Section under Rule 30(3) (see Decision of the President of the EPO dated 28 April 2011, OJ EPO 2011, 372 and the Notice from the EPO dated 18 October 2013, OJ EPO 2013, 542; see also A-IV, 5).

The particular requirements for drawings are dealt with in A-IX.

### 3.2.1 Physical requirements of applications filed by reference to a previously filed application

If the application is filed by reference to a previously filed application according to Rule 40(1)(c) (see A-II, 4.1.3.1), where no translation is required, the certified copy of the previously filed application required under Rule 40(3) must satisfy the physical requirements. If the previously filed application is not in an official language of the EPO, only the translation required under Rule 40(3) must satisfy the physical requirements, provided that the authenticity of the contents of the original is not impugned and that the original is of sufficient quality to allow good reproduction (Rule 49(12)).

### 3.2.2 Physical requirements of late-filed application documents

Where claims are filed after the date of filing (see A-III, 15) or where missing parts of the description, or drawings are inserted after the date of filing (see A-II, 5), all of these late-filed application documents must also satisfy the physical requirements. Consequently, the EPO will carry out two separate checks, first on the physical requirements of the original application documents, and second on any late-filed claims or missing parts of the description, or drawings.

In the event that late-filed missing parts of the description, or drawings result in a change of the date of filing, the applicant can withdraw the late-filed parts of the description, or drawings up to one month after being notified of the change in filing date (Rule 56(6)). Consequently, if the late-filed missing parts of the description, or drawings:

- (i) contain deficiencies with regard to the physical requirements, and
- (ii) result in a change of the date of filing

then the EPO will wait until the one-month period for their withdrawal has expired and will then send a communication according to Rule 58 in respect of these deficiencies, if the applicant has not withdrawn them in due time.

### 3.3 Other documents

*Rule 50(2)*

All documents other than those making up the application shall be typewritten or printed with a margin of about 2.5 cm on the left-hand side of each page.



### 3.4 Signature

*Rule 50(3)*

Documents, with the exception of annexed documents, filed after filing the application must be signed by the applicant or his representative (see A-VIII, 3).



## 4. Request for grant

### 4.1 General remarks

The request for grant must be made on the appropriate EPO form (Form 1001), even though the request (the indication that a patent is sought, referred to in A-II, 4.1(i)) need initially be in no particular form. Paper versions of Form 1001 are available to applicants free of charge from the EPO or competent national authorities with which applications may be filed. The form is furthermore available via the EPO website on the Internet and is also included in the EPO Online Filing software, which is obtainable free of charge from the EPO (see: *www.epo.org*).

*Rule 41(1)*

Whenever a new version of the Request for Grant form is issued, attention is drawn to this fact in the Official Journal of the EPO. It is recommended always to use the latest version.

### 4.2 Examination of the Request for Grant form

The Receiving Section examines the request to ensure that it contains the information listed in Rule 41(2). The request form provides for the entry of that information. The petition for the grant (Rule 41(2)(a)) is an integral part of the form. The applicant must be allowed to correct deficiencies in the request to the extent indicated in A-III, 16.

#### 4.2.1 Information on the applicant

The request must contain, in the manner specified in Rule 41(2)(c), the name, address and nationality of the applicant and the State in which his residence or principal place of business is located. Applicants (whether natural or legal persons) whose residence or principal place of business is in an EPC contracting state and who act without a professional representative can use an address for correspondence other than their residence. The address for correspondence must be the applicant's own address and must be in an EPC contracting state and be entered in the relevant form in the Box marked "Address for correspondence". Post cannot be sent to a different (natural or legal) person, since that requires a valid form of representation under Art. 133 and 134. Where the application is in the name of more than one applicant, the requirement must be satisfied for each applicant. At this stage in the proceedings, the formalities officer should have regard to the provisions of A-II, 2 governing the entitlement of the person named as applicant to apply for a patent.

#### 4.2.2 Signature

The request must be signed by the applicant or his representative. If there is more than one applicant, each applicant or his representative must sign the request. For further details as to the signature of the request, see A-VIII, 3.2 to 3.4.

*Rule 41(2)(h)*

(The provisions of Rule 41(2)(b), (e), (f) and (g), dealing respectively with the title of the invention, divisional applications, Art. 61 applications and claim to priority are considered under these headings in subsequent sections of this Chapter and in A-IV).

## 5. Designation of inventor

### 5.1 General remarks

*Art. 81*  
*Rule 19*  
*Rule 41(2)(j)*

Every application must designate the inventor. The designation is incorporated in the EPO Online Filing software. When filing on paper, the designation is filed in a separate document where the applicant is not the inventor or the sole inventor; otherwise the designation must be effected in the Request for Grant form (Form 1001) by placing a cross in the appropriate box in Section 22. Where the designation is effected in a separate document, a trilingual form available free of charge from the EPO or the central industrial property offices of the Contracting States should preferably be used (Form 1002).

### 5.2 Waiver of right to be mentioned as inventor

*Rule 20(1)*  
*Rule 143(1)(g)*  
*Rule 144(c)*  
*Art. 129(a)*

The inventor designated by the applicant may address to the EPO a written waiver of his right to be mentioned as inventor in the published European patent application and the European patent specification, in which case his name is not mentioned in the published European patent application, the European patent specification, the Register of European Patents (Rule 143(1)(g)) and, consequently, the European Patent Bulletin, always provided that the waiver is received in time. Moreover, in accordance with Rule 144(c), the designation of the inventor as well as the waiver is then excluded from file inspection pursuant to Art. 128(4).

### 5.3 Designation filed in a separate document

*Rule 19(1)*

Where the designation is filed in a separate document it must contain the surname, given names and full address (to meet the customary requirements for postal delivery) of the inventor, the statement, referred to in Art. 81, indicating the origin of the right to the patent and the signature of the applicant or his representative.

In the case of assignment, the words "by agreement dated ..." suffice, in the case of inventions by employees a mention that the inventor(s) is/are employee(s) of the applicant(s) and in the case of succession a mention that the applicant(s) is/are heir(s) of the inventor(s).

The designation of inventor must be signed by the applicant or his representative. With regard to the signature, the provisions set out in A-VIII, 3.2 to 3.4, apply.

*Rule 19(2)*

The EPO does not verify the accuracy of the information given in the designation of the inventor.

If the designation of inventor is filed subsequently, the requirements set out in A-VIII, 3.1 apply.

### 5.4 Notification

*Rule 19(3) and (4)*

If the applicant is not the inventor or is not the sole inventor, the Receiving Section must notify the inventor of the data contained in the document designating the inventor together with the data mentioned in

Rule 19(3) relating to the application. It should be noted, however, that neither the applicant nor the inventor may invoke either the omission of this notification or any errors contained in it.

The inventor is notified at his address as indicated by the applicant. If the notification is returned to the EPO because the inventor is not known at the address indicated or has moved to an unknown new address, the applicant is asked whether he knows the inventor's new address. If the applicant gives a new address, the inventor is notified at that address. Otherwise no further attempt at notification is made.

No notification is made where the inventor addresses to the EPO a written waiver of the notification under Rule 19(3) (see Notice of the EPO, OJ EPO 1991, 266). The waiver must be filed with the designation of inventor and contain the information to be supplied to the inventor by the EPO under Rule 19(3), i.e.:

- (i) the number and date of filing of the European patent application, if known;
- (ii) where the priority of an earlier application is claimed, the date and State of the earlier application, and its number, if known;
- (iii) the name of the applicant;
- (iv) the title of the invention;
- (v) the Contracting States designated in Section 32.1 of the Request for Grant form; and
- (vi) the name(s) of any co-inventor(s).

### 5.5 Deficiencies

Where a designation is not filed, or where the designation filed is deficient (e.g. inventor's name or address or the signature of the applicant is missing) so that it cannot be considered as validly filed, the applicant is informed that the European patent application will be refused if the deficiency is not remedied within the period prescribed under Rule 60(1), which is within 16 months of the date of filing or, if priority is claimed, of the date of priority. This time limit is deemed to have been met if the information is communicated before completion of the technical preparations for publication (see A-VI, 1.2). If the deficiencies are not rectified in due time, the application is refused and the applicant is notified accordingly (as regards divisional applications, see A-IV, 1.5). Further processing is possible according to Art. 121 and Rule 135.

*Art. 90(3) to (5)  
Rule 60(1)  
Art. 121*

### 5.6 Incorrect designation

An incorrect designation may be rectified provided a request is received accompanied by the consent of the wrongly designated person and by the consent of the applicant for or the proprietor of the

*Rule 21(1)*

patent where the request is not filed by that party. If a further inventor is to be designated, the consent of the inventor(s) previously designated is not necessary (see J 8/82). The provisions of A-III, 5.3 and 5.4 apply to the corrected designation *mutatis mutandis*. Rectification may also be requested after the proceedings before the EPO are terminated.

*Rule 21(2)*

Where an incorrect designation has been rectified and where the incorrect designation was entered in the European Patent Register or published in the European Patent Bulletin, its rectification or cancellation shall also be published therein.

## **6. Claim to priority (see also F-VI)**

### **6.1 General remarks**

The applicant for a European patent is entitled to and may claim the priority of an earlier first application where:

*Art. 87(1), (2) and (5)*

- (i) the previous application was filed in or for a State or WTO member recognised as giving rise to a priority right in accordance with the provisions of the EPC;
- (ii) the applicant for the European patent was the applicant, or is the successor in title to the applicant, who made the previous application;
- (iii) the European application is made during a period of twelve months from the date of filing of the first application (see, however, A-III, 6.6); and
- (iv) the European application is in respect of the same invention as the invention disclosed in the previous application (see also F-VI, 1).

As concerns (i) above, the previous application may be an application for a patent or for the registration of a utility model or for a utility certificate. However, a priority right based on the deposit of an industrial design is not recognised (see J 15/80).

*Art. 87(3)*

So long as the contents of the previous application were sufficient to establish a date of filing, it can be used to determine a priority date, irrespective of the outcome (e.g. subsequent withdrawal or refusal) of the application.

As concerns (ii) above, the transfer of the application (or of the priority right as such) must have taken place before the filing date of the later European application and must be a transfer valid under the relevant national provisions. Proof of this transfer can be filed later.

However, in the case of joint applicants filing the later European patent application, it is sufficient if one of the applicants is the applicant or successor in title to the applicant of the previous application. There is



no need for a special transfer of the priority right to the other applicant(s), since the later European application has been filed jointly. The same applies to the case where the previous application itself was filed by joint applicants, provided that all these applicants, or their successor(s) in title, are amongst the joint applicants of the later European patent application.

## 6.2 Applications giving rise to a right of priority

Applications giving rise to a right of priority referred to in A-III, 6.1(i) are those filed at industrial property offices:

- (a) of or acting for States party to the Paris Convention for the Protection of Industrial Property, *Art. 87(1)*
- (b) of or acting for any member of the World Trade Organisation (WTO), or *Art. 87(1)*
- (c) not subject to either the Paris Convention or the Agreement establishing the WTO, but where: *Art. 87(5)*
  - (i) that authority recognises that a first filing made at the EPO gives rise to a right of priority under conditions and with effects equivalent to those laid down in the Paris Convention, and
  - (ii) the President of the EPO issues a communication indicating this.

To date, no such communication referred to in (c)(ii) has been issued and so this does not as yet apply. Furthermore, the members of the WTO do not necessarily have to be States as such, but may also be intergovernmental bodies or regions with special status such as the Separate Customs Territory of Taiwan, Penghu, Kinmen and Matsu.

In view of the wording of Art. 87(1) which refers to filings "in or for" any State party to the Paris Convention or member of the WTO, priority may be claimed of an earlier first filed national application, European application or international application. This includes the US "provisional application for patent" (Notice from the President of the EPO dated 26 January 1996, OJ EPO 1996, 81). A list of the countries party to the Paris Convention is published on WIPO's website and is regularly published in the Official Journal of the EPO. Likewise a list of the members of the WTO is published on the website of the WTO, and this list is also regularly updated.

The decisions G 2/02 and G 3/02 previously excluded the possibility of claiming priority from an application filed at the industrial property authority of members of the WTO which were not also signatory states to the Paris Convention (Art. 87(1) EPC 1973). This exclusion no longer applies under the revised Art. 87(1).

### 6.3 Multiple priorities

*Art. 88(2)*

The applicant may claim more than one priority based on previous applications in the same or different States and/or WTO members. Where multiple priorities are claimed, time limits which are calculated from the priority date run from the earliest date of priority and, as a result, the European application must be made within twelve months from the earliest priority (see, however, A-III, 6.6); this applies if earlier applications have been filed in any of the industrial property offices mentioned in A-III, 6.2.

### 6.4 Examination of the priority document

The Receiving Section need not examine the content of the priority document. However, where it is obvious, e.g. from the title of the document, that the document relates to subject-matter quite different from that of the application, the applicant should be informed that it appears that the document filed is not the relevant document.

### 6.5 Declaration of priority

*Art. 88(1)*

*Rule 52(1)*

*Rule 41(2)(g)*

*Art. 90(4)*

An applicant wishing to claim priority must file a declaration of priority indicating:

- (i) the date of the previous application,
- (ii) the State or WTO member in or for which it was filed and
- (iii) its file number.

The declaration of priority shall preferably be made on filing the European patent application (Rule 52(2)). In such a case the declaration of priority, indicating at least the date on which and the country for which the earlier application was filed, should be present in the Request for grant form (Rule 41(2)(g)). However, if a priority claim is added or corrected after the Request for grant form has been filed (see A-III, 6.5.1 and 6.5.2), the applicant will not be invited by the EPO to file a corrected Request for grant. ==

The time limit for filing the certified copy of the priority document is the same as the time limit for making the priority claim (see A-III, 6.5.1 and 6.7). Consequently, where:

- (a) the applicant supplies the certified copy on time
- (b) it is in an official language of the EPO
- (c) the date and file number are indicated on the certified copy

then the requirements of Rule 52(1) with regard to providing the date and file number of the priority are met.

### 6.5.1 Filing a new priority claim

The declaration of priority should preferably be made on filing, but can be made up to 16 months from the earliest priority date claimed. That is to say, items (i)-(iii) mentioned in A-III, 6.5 can be supplied up to 16 months after the earliest claimed priority. Where the priority claim is inserted after the filing date and causes a change in the earliest priority date, this 16 month period is calculated from that new earliest priority date in accordance with Art. 88(2).

*Rule 52(2)*

The applicant cannot request further processing in respect of the time limit for introducing a new priority claim under Rule 52(2), since it is excluded by Rule 135(2).

### 6.5.2 Correcting an existing priority claim

The applicant may correct the declaration of priority within 16 months from the earliest priority date. Where the correction causes a change in the earliest claimed priority date, this time limit is the earlier to expire of:

*Rule 52(3)*

- (i) 16 months from the earliest priority date as originally claimed.
- (ii) 16 months from the earliest priority date as corrected.

However, this time limit cannot expire earlier than four months after the date of filing. Thus, if the originally claimed priority date is incorrect and precedes the date of filing by more than twelve months, the applicant will always have at least four months to correct this date, i.e. the same period as if he had claimed the correct priority date (and for example got the file number wrong) and claimed a full twelve-month priority period.

If the applicant files a request for correction later it may, exceptionally, be allowed if it is apparent on the face of the published application that a mistake has been made (see A-V, 3 and other sources therein).

### 6.5.3 Deficiencies in the priority claim and loss of the priority right

⊕

Four potential deficiencies exist with regard to the priority claim, namely:

*Art. 90(4) and (5)*

≡

- (i) failure to indicate a date of the previous application or to indicate the correct date
- (ii) failure to indicate a state or WTO member in or for which it was filed or to indicate the correct state or WTO member
- (iii) failure to supply a file number
- (iv) failure to indicate the correct file number.

|

Deficiencies (i) and (ii) can only be corrected in accordance with the procedures and within the time limit indicated in A-III, 6.5.2. Failure to correct either of these deficiencies in time results in the loss of the priority right in question according to Art. 90(5). Further processing does not apply to the time limit under Rule 52(3), since it is excluded by Rule 135(2).

*Rule 59*  
*Art. 90*

However, where the applicant has failed to indicate the file number of the previous application (deficiency (iii)), as required by Rule 52(1), before expiry of the time limit under Rule 52(2), he is invited by the EPO to provide it within a period to be specified according to Rule 59. Failure to reply in time to this communication results in the loss of the priority right in question according to Art. 90(5). Further processing does not apply to the time limit under Rule 59 either, since it is also excluded by Rule 135(2).

In the event that the applicant has failed to indicate the correct file number of the priority application (deficiency (iv)), a request for correction under Rule 139 can be filed (see A-V, 3).

## **6.6 Priority period**

*Art. 122*  
*Rule 136*  
*Rule 133*  
*Rule 134*

Where the date of a priority claim precedes the date of filing of the European patent application by more than twelve months, the applicant may be informed by the Receiving Section that there shall be no priority for the application unless he:

- (i) indicates a corrected date lying within the twelve-month period preceding the date of filing and does so within the time limit according to Rule 52(3) (see A-III, 6.5.2), or
- (ii) requests re-establishment of rights in respect of the priority period and does so within two months of the expiry of the priority period, and this request is subsequently granted (see paragraph below). This only applies where the applicant also filed the European application within the same two-month period.

Rules 133 and 134 apply to the priority period under Art. 87(1). In the event that the date indicated for the previous application is subsequent to or the same as the date of filing, the procedure set out in A-III, 6.5.2 also applies (with regard to the possibility of effecting correction of clerical or similar errors, see A-V, 3).

According to Art. 122 and Rule 136(1) it is possible to obtain re-establishment of rights in respect of the priority period (twelve months according to Art. 87(1)). The request for re-establishment must be filed within two months of expiry of the priority period (Rule 136(1)) and the omitted act, i.e. the establishment of a date of filing for the European application, must also be completed in this period (Rule 136(2)). For more details on requesting re-establishment of rights see E-VII, 2.2.

### 6.7 Copy of the previous application (priority document)

A paper copy of the previous application for which priority is claimed (priority document) must be filed before the end of the sixteenth month after the date of priority. Where multiple priorities are claimed, the above-mentioned time limit runs from the earliest date of priority.

*Rule 53(1)*

*Art. 88(2)*

*Art. 90(4)*

The copy must be certified as an exact copy of the previous application by the authority which received the previous application and must also be certified by that authority as to its date of filing. This certification of the date may take the form of a separate certificate issued by that authority stating the date of filing of the previous application (Rule 53(1), second sentence) or may be an integral part of the priority document itself. The certification of the authenticity of the copy may also be a separate document or an integral part of the priority document.

It is also possible to file a copy of the previous application (priority document) on physical media other than paper, e.g. CD-R, provided that:

- (i) the physical medium containing the priority document is prepared by the authority which received the previous application, such as to guarantee that its content cannot undetectably be altered subsequently;
- (ii) the content of the physical medium is certified by that authority as an exact copy of the previous application or the part contained therein; and
- (iii) the filing date of the previous application is also certified by that authority.

The certificate(s) may be filed separately in paper form. The submitted medium must be readable and free of computer viruses and other forms of malicious logic.

Rule 53(2) together with the Decision of the President of the EPO dated 9 August 2012, OJ EPO 2012, 492 provide for the following exceptions to the requirement that a priority document be filed.

*Rule 53(2)*

If the previous application is:

- (i) a European patent application;
- (ii) an international application filed with the EPO as receiving Office under the PCT;
- (iii) a Chinese patent or utility model application
- (iv) a Japanese patent or utility model application;

- (v) a Korean patent or utility model application, or
- (vi) a US patent application or provisional patent application subject to the document exchange agreement with the USPTO (see OJ EPO 2007, 473),

then the EPO will include free of charge a copy of the previous application in the file of the European patent application. No request is necessary to this end. However, as regards Chinese patent or utility model applications, this applies only if these were filed on or after 3 September 2012. Moreover, if the language of the previous application was not one of the official languages of the EPO, it may still be necessary to file the translation or declaration under Rule 53(3) (see A-III, 6.8).

Where the applicant has already supplied a copy of the priority in the context of a request to base late-filed parts of the description or drawings on the claimed priority under Rule 56 (see A-II, 5.4(v)), the applicant does not need to file it again. However, if the copy already provided was not certified as to its content and/or filing date, the applicant will need to provide the missing certification within the above time limit.

*Art. 90(4) and (5)*  
*Rule 59*

If the applicant fails to provide a certified copy of the priority document within the above-mentioned period (Rule 53(1)), the EPO will invite him to provide it within a period to be specified according to Rule 59. If the applicant fails to provide it within this period, the priority right in question is lost (Art. 90(5)). Further processing does not apply to the time limit according to Rule 59, since this is excluded according to Rule 135(2).

*Art. 88(1)*  
*Rule 53(3)*

### **6.8 Translation of the previous application**

Where the previous application claimed as priority is not in an official language of the EPO and the validity of the priority claimed is relevant to the assessment of the patentability of the invention concerned, the EPO shall invite the applicant for or proprietor of the European patent to file a translation into an official language of the EPO within a period to be specified.

#### **6.8.1 Invitation to file the translation before examination**

Where the Search Division notes that a translation of the priority is required, the invitation to provide it according to Rule 53(3) may be sent at the same time as either item (i) or item (ii) below:

- (i) the communication according to Rule 69(1) and Rule 70a(1) (where the applicant does not file the request for examination before the search report is transmitted to him - see A-VI, 2.1).

In this case, the time limit for providing the translation is the same as that for filing the request for examination, namely six

months from the date of mention of the publication of the European search report according to Rule 70(1).

- (ii) the communication according to Rule 70(2) (where the applicant files the request for examination before the (supplementary) European search report is transmitted to him - see A-VI, 2.3).

In this case the time limit for providing the translation is the same as that for filing the confirmation of the request for examination according to Rule 70(2):

- (a) For applications not filed via the PCT, this is six months from the date of mention of the publication of the European search report (see A-VI, 2.3).
- (b) For Euro-PCT applications subject to the preparation of a supplementary European search report (see B-II, 4.3.2), this is six months from the notification of the communication according to Rule 70(2) (see E-VIII, 2.5.3).

In practice the invitation according to Rule 53(3) will be sent in a separate communication to the applicant and, in some cases, might not be despatched on exactly the same date as the applicable communication indicated in (i) or (ii) above. However, this will not affect the date of expiry of the period for providing the translation, since the relevant event used in its calculation (the mention of the publication of the European search report or the notification of the communication under Rule 70(2)) is not related to the notification of the invitation according to Rule 53(3).

### **6.8.2 Invitation to file the translation in examination/opposition**

The period set under Rule 132(2) for providing the translation in either examination or opposition proceedings will be four months.

If not sent earlier (see A-III, 6.8.1), an invitation according to Rule 53(3) may be sent in examination proceedings either alone or as an annex to a communication according to Art. 94(3). When sent as an annex to a communication according to Art. 94(3), the time limit set for reply to that communication will be the same as that for providing the translation (i.e. four months), even where the issues raised in the communication are minor (see E-VII, 1.2).

For Euro-PCT applications where the EPO acted as the ISA or the Supplementary International Searching Authority (SISA, Rule 45bis PCT), an invitation according to Rule 53(3) may be sent by the Examining Division only after the period according to Rule 161(1) has expired (see E-VIII, 3.2).

Since the proprietor of a European patent might not have previously been invited to file a translation (in the examination procedure or earlier

as indicated in A-III, 6.8.1), in cases where the validity of the claimed priority becomes relevant in the assessment of patentability in opposition proceedings, the EPO may make the above invitation during the opposition procedure.

In examination and opposition proceedings, where the applicant or proprietor has been invited to provide the translation, no summons to oral proceedings will be sent until either the translation is provided or the period for further processing in respect of the time limit according to Rule 53(3) has expired, whichever is the earlier.

In practice, the Search, Examining or Opposition Division dealing with the patent application or patent will inform the Formalities Officer that a translation of the priority is required and the Formalities Officer will then despatch the above communication.

### **6.8.3 Loss of rights and legal remedies**

If the applicant for or proprietor of the European patent does not provide the translation in time, the right of priority is lost and the applicant or proprietor is informed accordingly (see A-III, 6.11). This has the effect that the intermediate document(s) which resulted in the validity of the priority claimed becoming relevant for the assessment of patentability will belong to the prior art under Art. 54(2) or Art. 54(3) as applicable. There is no further invitation to the applicant or proprietor to file the translation. However, if the applicant fails to observe this time limit, he can request further processing according to Art. 121 and Rule 135. Where appropriate, the applicant can request a decision under Rule 112(2). In the event of failure to file the translation in time in opposition proceedings, the proprietor can request either a decision according to Rule 112(2) (see E-VII, 1.9.3) or re-establishment of rights according to Art. 122 and Rule 136 (see E-VII, 2.2). Further processing is not available to the patent proprietor in opposition proceedings.

Where translations of more than one priority document are requested and not provided in time, one further processing fee is due according to Rule 135(1) and Art. 2(1), No. 12, RFees for each of these priorities. This applies even where the translations were requested in a single Rule 53(3) invitation.

### **6.8.4 Translation of priority already filed**

Where the applicant has already supplied a translation of the priority in the context of a request to base late-filed parts of the description or drawings on the claimed priority under Rule 56 (see A-II, 5.4(vi)), the applicant does not need to file it again.

### **6.8.5 Voluntary filing of the translation of the previous application**

The applicant for or proprietor of the European patent can file a translation of his priority of his own motion at any time during examination or opposition proceedings before the EPO.



### 6.8.6 Declaration replacing the translation

Alternatively, a declaration that the European patent application is a complete translation of the previous application may be submitted within those same time limits (see also F-VI, 3.4, and D-VII, 2). The declaration may already be made by crossing the appropriate box in the Request for Grant form (Form 1001). This declaration is only valid if the text of the European application as filed is an exact translation of the text of the earlier application of which priority is claimed. If the European application did not contain claims on the date of filing (see A-II, 4.1), the applicant can file these later (see A-III, 15). In such cases, for the declaration to be valid, the description of the European application must be an exact translation of the description of the claimed priority, regardless of whether the priority application contained claims on its filing date. However, where the European application contains claims on its date of filing and the priority application did not contain claims on its filing date or contained fewer claims on its filing date, the declaration is not valid. Furthermore, if the European application contains more or less text than is contained in the earlier application as filed, such a declaration cannot be accepted. Where the declaration cannot be accepted for any of the above reasons, in order to comply with the requirement for filing a translation, a complete translation must be filed within the set time limit. A merely different arrangement of the various elements (i.e. the claims vs. the description) of the application does not affect the validity of such a declaration (for example, the claims are presented at the end of the application, whereas in the priority application they are at the beginning), nor does a different type of reference sign (e.g. Arabic rather than Roman numerals). However, a declaration is not acceptable if changes have been made within the parts of the application (e.g. different order of claims, added reference signs) or if sections of the application (e.g. listing of components, section headings and words in the drawings) are not identical to those in the priority application.

### 6.9 Non-entitlement to right to priority

A European patent application has no right to priority if:

- (i) the application was not filed within the twelve-month period referred to in A-III, 6.1(iii) and the applicant has neither:
  - (a) corrected the priority date on time (see A-III, 6.5.2), such that the date of filing of the European application no longer exceeds the twelve-month priority period under Art. 87(1), nor
  - (b) successfully requested re-establishment of rights in respect of the priority claim (see A-III, 6.6)
- (ii) the previous application did not seek an industrial property right giving rise to a priority right (see A-III, 6.1); or

*Art. 87(1)*

*Art. 87(1)*

- Art. 87(1) and (4)* (iii) the previous application does not give rise to a priority right in respect of the State, WTO member or industrial property authority in or for which it was filed (see A-III, 6.1(i) and 6.2).

### **6.10 Loss of right to priority**

*Art. 90(4) and (5)* The right to priority for a European patent application is lost where:

*Rule 53(3)*

- (i) the declaration of priority is not filed in due time (see A-III, 6.5.1);
- (ii) the declaration of priority is not corrected in due time (see A-III, 6.5.2 and 6.5.3);
- (iii) the certified copy of the previous application is not filed in due time (see A-III, 6.7); or
- (iv) the translation of the previous application or the declaration referred to in A-III, 6.8.6 is not filed in due time in response to an invitation according to Rule 53(3) (see A-III, 6.8.3).

### **6.11 Notification**

*Rule 112(1)*

The applicant is notified of any non-entitlement to, or loss of, a priority right. The computation of time limits that depend on the priority will take this new situation into account. This also applies where entitlement to a priority right is surrendered. The termination of a priority right has no effect on a time limit which has already expired (see also F-VI, 3.4 and E-VII, 1.5). If the search has not yet been carried out, the Receiving Section notifies the Search Division of a loss of, or non-entitlement to, a priority date.

### **6.12 Copy of the search results for the priority or priorities**

*Rule 141(1)*

An applicant claiming priority within the meaning of Art. 87 must file a copy of the results of any search carried out by the authority with which the priority application was filed together with the European patent application, in the case of a Euro-PCT application on entry into the European phase, or without delay after such results have been made available to him. This requirement also applies to priority claims which are subsequently withdrawn or lapse and to priority claims introduced or corrected after the filing date (see A-III, 6.5.1 and 6.5.2). The obligation under Rule 141(1) exists as long as the application is pending before the EPO. This requirement applies to all European and Euro-PCT applications filed on or after 1 January 2011 (OJ EPO 2009, 585). In the case of divisional applications, the relevant date is that on which the divisional application was received by the EPO (see A-IV, 1.2.1), not the filing date of the parent application. Where the copy is not provided to the EPO before the Examining Division assumes responsibility, the procedure is as set out in C-II, 5, and III, 5.

Where multiple priorities are claimed, the copy of the search results referred to above must be provided for all applications claimed as priority. If the search results are not drawn up in an official language of the EPO, no translation is required. The copy of the search results

submitted must be a copy of the official document issued by the office where the priority was filed. A simple listing of the prior art drawn up by the applicant will not suffice. Copies of the cited documents do not have to be provided (see the Notice from the EPO dated 28 July 2010, OJ EPO 2010, 410).

The copy referred to in Rule 141(1) is deemed to be duly filed if it is available to the EPO and is to be included in the file of the European patent application under the conditions determined by the President. According to the Decision of the President dated 5 October 2010, OJ EPO 2010, 600, for the time being these exceptions are not based on an agreement with the national patent offices, but are limited to cases where a search report of the following type was drawn up by the EPO on an application whose priority is claimed:

*Rule 141(2)*

- (i) European search report (Art. 92)
- (ii) international search report (Art. 15(1) PCT)
- (iii) international-type search report (Art. 15(5) PCT)
- (iv) search report prepared on behalf of a national office on a national application (Belgium, Cyprus, France, Greece, Italy, Lithuania, Luxembourg, Malta, Netherlands, San Marino, Turkey).

Furthermore, according to the Decisions of the President dated 9 December 2010 (OJ EPO 2011, 62), 19 September 2012 (OJ EPO 2012, 540) and 27 February 2013 (OJ EPO 2013, 216), the EPO includes in the file of a European patent application a copy of the search results referred to in Rule 141(1), thus exempting the applicant from filing said copy, where the priority of a first filing made in one of the following states is claimed:

- Japan
- United Kingdom
- United States of America
- Austria
- Republic of Korea.

Furthermore, for divisional applications, where the results of the search on the claimed priority have already been provided in respect of the parent application, the applicant need not provide them again in respect of the divisional application (see the Notice from the EPO dated 28 July 2010, OJ EPO 2010, 410).

## 7. Title of the invention

### 7.1 Requirements

*Rule 41(2)(b)*

The request for grant must contain the title of the invention. A requirement of Rule 41(2)(b) is that the title must clearly and concisely state the technical designation of the invention and must exclude all fancy names. In this regard, the Receiving Section should take the following into account:

- (i) personal names, fancy names, the word "patent" or similar terms of a non-technical nature which do not serve to identify the invention should not be used;
- (ii) the abbreviation "etc.", being vague, should not be used and should be replaced by an indication of what it is intended to cover;
- (iii) titles such as "Method", "Apparatus", "Chemical Compounds" alone or similar vague titles do not meet the requirement that the title must clearly state the technical designation of the invention;
- (iv) trade names and trademarks should also not be used; the Receiving Section, however, need only intervene when names are used which, according to common general knowledge, are trade names or trademarks.

### 7.2 Responsibility

*Rule 41(2)(b)*

The ultimate responsibility for ensuring that the title accords with the provisions of the Implementing Regulations rests with the Examining Division. The Receiving Section should nevertheless take action to avoid, if possible, the publication of applications having titles which are clearly non-informative or misleading. It is necessary therefore that the Receiving Section takes cognisance of the provisions of Rule 41(2)(b) as set out in A-III, 7.1. In the event of obvious non-compliance with the provisions, the EPO will of its own motion change the title, if this appears necessary, without informing the applicant there and then. Only when the application is about to be published will the applicant be notified whether the title proposed by him has been changed (see OJ EPO 1991, 224).

## 8. Prohibited matter

### 8.1 Morality or "ordre public"

*Art. 53(a)*

*Rule 48(1)(a) and (2)*

The application must not contain statements or other matter contrary to "ordre public" or morality. Such matter may be omitted when the application is published, the published application indicating the place and number of words or drawings omitted. (Where drawings are omitted regard should be had to the physical requirements of A-III, 3.2). The Receiving Section may check the description, claims and drawings to ascertain whether they contain offending matter. In order not to delay unduly the formalities examination, if carried out, this

will entail a cursory examination to ensure that the application does not contain the following prohibited matter: statements constituting an incitement to riot or to acts contrary to "ordre public", racial, religious or similar discriminatory propaganda, or criminal acts and grossly obscene matter. The Receiving Section may also take action to prevent the publication of such matter where the Search Division draws its attention to such matter which it had overlooked. The applicant is notified of the material omitted. In practice, it will usually be the Search Division which brings the existence of such material in the application to the attention of the Receiving Section.

## 8.2 Disparaging statements

According to Rule 48(1)(b), the application must not contain statements disparaging the products or processes of any particular person other than the applicant, or the merit or validity of applications or patents of any such person. However, mere comparisons with the prior art are not to be considered disparaging *per se*. Statements clearly coming within this category that become evident from the cursory examination referred to in A-III, 8.1, or to which attention is drawn by the Search Division, may be omitted by the Receiving Section when publishing the application. In cases of doubt the matter should be left for consideration to the Examining Division. The published application must indicate the place and number of any words omitted and the EPO must furnish, upon request, a copy of the passage omitted. The applicant is again notified of the material omitted. (See also treatment of prohibited matter in proceedings before the Examining Division, F-II, 7).

*Rule 48(1)(b) and (3)*

## 9. Claims fee

A European application which contains more than fifteen claims at the time of filing the claims (see the paragraph below) incurs payment of a claims fee in respect of each claim over and above that number. For applications filed and international applications entering the regional phase on or after 1 April 2009, a higher amount is payable for each claim in excess of 50. The claims' order is their sequence at their time of filing. If an application contains more than one set of claims, Rule 45 is only applicable for the set of claims containing the highest number of claims. If, as a result of claims having been deleted owing to non-payment of claims fees, the number of claims remaining in the set that originally incurred the fees is reduced with the result that another set then has the greatest number, the number of claims in the latter set has to be reduced to the same number as that remaining in the set originally incurring the fees (see J 8/84). The claims fees must be paid within one month after the claims are filed.

*Rule 45(1) to (3)*

*Rule 112(1)*

*Rule 37(2)*

*Art. 2(1), No. 15,*

*RFees*

The claims may be filed at the following stages:

- (i) on the European filing date (see A-II, 4.1.5)

- (ii) after the European filing date, in a timely response to a communication from the EPO indicating their absence under Rule 58 (see A-III, 15)
- (iii) after the European filing date, by the applicant of his own motion before the EPO sends a communication according to Rule 58 (see A-III, 15)

Consequently, the claims fees must be paid within one month of whichever of the above dates of receipt applies.

If the claims fees have not been paid in due time, they may still be validly paid within a non-extendable period of grace of one month of notification of a communication pointing out the failure to observe the time limit. If a claims fee is not paid within the period of grace, the claim concerned is deemed to be abandoned and the applicant is notified to that effect. If the claims fees paid are insufficient to cover all the claims incurring fees (i.e. claim no. 16 onwards), and if when payment was made no indication was given as to which claims were covered by the fees paid, then the applicant is requested to specify which claims incurring fees are covered by the claims fees paid. The Receiving Section notifies the Search Division of claims that are deemed abandoned. Any claims fee duly paid is refunded only in the case referred to in Rule 37(2) (see A-II, 3.2, last paragraph).

In cases where:

- (i) the application was filed by reference to a previously filed application (see A-II, 4.1.3.1), and
- (ii) the applicant indicates on filing that the claims of this previously filed application take the place of claims in the application as filed,

the claims fees are due within one month of the filing date (since the claims of the previous application are effectively present on the European filing date). However, the EPO will not send the applicant a communication under Rule 45(2) inviting him to pay any claims fees due, until the applicant has filed the copy of the previous application, within two months of the filing date (Rule 40(3)), since it is only at this point that the EPO will know how many claims there are and consequently, how many claims fees, if any, are due.

Features of a claim deemed to have been abandoned pursuant to Rule 45(3) and which are not otherwise to be found in the description or drawings cannot subsequently be reintroduced into the application and, in particular, into the claims (see J 15/88).

Regarding Euro-PCT applications entering the European phase, see E-VIII, 2.1.3 and 2.3.8.

## 10. Abstract

### 10.1 General remark

Every application for a patent must contain an abstract. The effect of non-compliance with this requirement is dealt with in A-III, 16.

*Art. 78(1)(e)*

*Art. 90(3)*

*Rule 57(d)*

### 10.2 Content of the abstract

The definitive content of the abstract is the responsibility of the EPO. Since the definitive content of the abstract must be determined and transmitted to the applicant along with the search report, in practice this means in particular the Search Division. However, where it is obvious that the abstract filed does not belong to the application, and this should normally be confirmed by the Search Division, the applicant is informed that the document filed does not constitute an abstract and that unless he corrects the deficiency the sanction referred to in A-III, 16 will apply.

*Rule 66*

### 10.3 Figure accompanying the abstract

If the application contains drawings, the applicant should indicate the figure (or exceptionally figures) of the drawings which he suggests should accompany the abstract. Where this requirement is not met, the Search Division decides which figure(s) to publish. For the further procedure see F-II, 2.4.

*Rule 47(4)*

## 11. Designation of Contracting States

### 11.1 General remarks

All Contracting States party to the EPC at the filing date of the application shall be deemed to be designated in the request for grant of a European patent (for a list of the EPC Contracting States, see the General Part of the Guidelines, section 6). Any other State entered on the request for grant must be disregarded (see for the designation of Contracting States on the Request for Grant form, A-III, 11.2.2, 11.3.5 and 11.3.6). As indicated in A-II, 2, when the application is in the name of joint applicants, each may designate different Contracting States; objection should be raised during the course of the examination for formal requirements if there is any ambiguity as to the States designated by the individual applicants.

*Art. 79(1)*

### 11.2 European patent applications filed on or after 1 April 2009

#### 11.2.1 Designation fee; time limits

The designation of Contracting States is subject to payment of a designation fee.

*Art. 79(2)*

*Rule 39*

*Art. 149(1)*

For applications filed on or after 1 April 2009 this is a flat designation fee covering all EPC Contracting States. Therefore, for these applications, the system of charging designation fees for individual designated states (see A-III, 11.3) no longer applies. For European divisional applications see also A-IV, 1.3.4 and 1.4.1.

*Art. 2(1), No. 3 RFees*

*Rule 39* For European patent applications, the designation fee must be paid within six months of the date on which the European Patent Bulletin mentions the publication of the European search report.

*Rule 17(3)*  
*Rule 36(4)* For divisional applications and new applications under Art. 61(1)(b), the designation fee must be paid within six months of the date on which the European Patent Bulletin mentions the publication of the European search report drawn up in respect of the European divisional application or the new European patent application (see A-IV, 1.4.1).

For Euro-PCT applications entering the European phase on or after 1 April 2009, see A-III, 11.2.5.

### 11.2.2 Payment of designation fee

*Rule 39(2)* The automatic designation of all the Contracting States party to the EPC at the time of filing of the European patent application is effected by the filing of the application, whereas the designation fee may be paid later (see A-III, 11.2.1).

*Art. 2(1), No. 3 RFees* Payment of the designation fee covers all the Contracting States, except those States the designation of which has been expressly withdrawn. ══

*Art. 6(1) RFees* Such payment simply needs to be marked "designation fee" in order for the purpose of the payment to be established. |

### 11.2.3 Consequences of non-payment of the designation fee

*Rule 39(2)* Where the designation fee has not been paid by expiry of the period specified in Rule 39(1), the application is deemed to be withdrawn.

In this case, the EPO sends the applicant a communication under Rule 112(1) notifying him of this loss of rights. In response to this communication, the applicant can request further processing according to Art. 121 and Rule 135 (see E-VII, 2.1).

The loss of rights ensues on expiry of the normal period under Rule 39(1) and not upon expiry of the period for further processing (see G 4/98, *mutatis mutandis*).

For Euro-PCT applications entering the European phase on or after 1 April 2009, see A-III, 11.2.5.

### 11.2.4 Withdrawal of designation

*Art. 79(3)*  
*Rule 39(2) and (3)* Subject to the final sentence of this paragraph, the designation of one or more Contracting States may be withdrawn by the applicant at any time up to the grant of the patent. Withdrawal of the designation of all the Contracting States results in the application being deemed to be withdrawn and the applicant is notified accordingly. ══

*Rule 15* In neither case is the designation fee refunded. The designation of a Contracting State may not be withdrawn as from the time when a third |



party proves to the EPO that he has initiated proceedings concerning entitlement and up to the date on which the EPO resumes proceedings for grant.

The applicant may withdraw designations when filing the European application, for example to avoid overlapping prior national rights with the priority application according to Art. 139(3). Timely payment of the designation fee will not cause those designations which have been withdrawn to be re-activated.

For European divisional applications see A-IV, 1.3.4.

### **11.2.5 Euro-PCT applications entering the European phase**

For Euro-PCT applications entering the European phase, the designation fee must be paid within 31 months of the filing or priority date, if the time limit specified in Rule 39(1) has expired earlier.

*Rule 159(1)(d)*

According to Rule 160(1), if the designation fee for the Euro-PCT application entering the European phase is not paid within the basic period under Rule 159(1)(d), the European patent application (see Art. 153(2)) is deemed to be withdrawn. If the EPO finds that such deemed withdrawal of the European patent application has occurred, it notifies the applicant of this loss of rights according to Rule 112(1). In response to this communication, the applicant can request further processing according to Art. 121 and Rule 135 (see E-VII, 2.1).

*Rule 160  
Art. 153(2)*

For the designation fee in relation to Euro-PCT applications entering the European phase, see also E-VIII, 2.1.3 and 2.3.11.

### **11.3 European patent applications filed before 1 April 2009**

In this section reference is made to the old version of the relevant provisions, which remain applicable to European patent applications filed and Euro-PCT applications entering the European phase before 1 April 2009.

#### **11.3.1 Designation fee; time limits**

The designation of a Contracting State is subject to payment of a designation fee. A single joint designation fee is payable for Switzerland and Liechtenstein. The designation fees are deemed paid for all Contracting States upon payment of seven times the amount of one designation fee.

*Art. 79(2)  
Rule 39, old version  
Art. 149(1)  
Art. 2(2), Nos. 3 and  
3a RFees*

For European patent applications, the designation fees must be paid within six months of the date on which the European Patent Bulletin mentions the publication of the European search report.

For divisional applications and new applications under Art. 61(1)(b) filed before 1 April 2009, the designation fees must be paid within six months of the date on which the European Patent Bulletin mentions the publication of the European search report drawn up in respect of the

*Rule 17(3), old  
version  
Rule 36(4), old  
version*

European divisional application or the new European patent application (see A-IV, 1.4.1).

For Euro-PCT applications entering the European phase before 1 April 2009, see A-III, 11.3.9.

### **11.3.2 Consequences of non-payment of designation fees**

*Rule 39(2), old version*

Where the designation fee has not been paid in due time in respect of any designated State, the designation of that State shall be deemed to be withdrawn (see also A-III, 11.3.4).

If the designation fee for a particular Contracting State is not paid in time, the EPO sends the applicant a communication under Rule 112(1) notifying him of the deemed withdrawal of the designation in question according to Rule 39(2). In response to this communication, the applicant can request further processing according to Art. 121 and Rule 135 in respect of this partial loss of rights (see E-VII, 2.1). This communication is not sent if the applicant waives the right to receive it in respect of the state in question, by crossing the appropriate box in the Request for grant form. By crossing this box, the applicant waived his right to further processing in respect of the designation or designations in question.

For Euro-PCT applications entering the European phase before 1 April 2009, see A-III, 11.3.9.

### **11.3.3 Amount paid insufficient**

*Art. 6(2), 1st sentence, RFees*

If, during the period for requesting further processing, designation fees are paid without an additional sum sufficient to cover the amount of the further processing fee, it is first necessary to establish how many designation fees including the further processing fee are covered by the total sum paid for that purpose. The applicant must then be invited, pursuant to Art. 6(2), first sentence, RFees, to inform the EPO for which Contracting States the designation fees plus further processing fee are to be used (see J 23/82, *mutatis mutandis*). For the subsequent procedure, see A-III, 11.3.7.

### **11.3.4 Application deemed to be withdrawn**

*Rule 39(3), old version*

Where no designation fee is validly paid by expiry of the period specified in Rule 39(1), the application is deemed to be withdrawn.

If no designation fees are paid on time leading to a deemed withdrawal of the application under Rule 39(3), old version, the EPO sends the applicant a communication according to Rule 112(1) notifying him of this loss of rights. In response to this communication, the applicant can request further processing according to Art. 121 and Rule 135 in respect of this total loss of rights (see E-VII, 2.1).

Where the application is deemed to have been withdrawn because of failure to pay the designation fees, the loss of rights ensues on expiry of the normal period under Rule 39(1). Similarly, the deemed

withdrawal of a designation of a Contracting State takes effect upon expiry of the normal period under Rule 39(1), and not upon expiry of the period for further processing (see G 4/98, *mutatis mutandis*). The applicant is notified of the loss of rights and can remedy it by requesting further processing according to the procedures explained in A-III, 11.3.2.

### 11.3.5 Request for Grant form

The automatic designation of all of the Contracting States party to the EPC at the time of filing of a European patent application is effected by the filing of the application, whereas the designation fees payable for an application filed before 1 April 2009 may be paid later.

*Art. 79(1) and (2)*

The applicant has time – until expiry of the period for paying the designation fees (Rule 39(1) and Rules 17(3) and 36(4)) – to decide which Contracting States he actually wants his patent to cover. This he does by paying the designation fees for those States, which may include an additional sum required to validate a request for further processing.

### 11.3.6 Indication of the Contracting States

For European patent applications filed before 1 April 2009, the designation fees are deemed paid for all Contracting States upon payment of seven times the amount of one designation fee. Such payment simply need be marked "Designation fees" in order for the purpose of the payment to be established.

*Art. 2(2), No. 3 RFees  
Art. 6(1) RFees*

If, on the other hand, the applicant intended to pay fewer than seven designation fees when filing the application, he should have indicated the relevant Contracting States in the appropriate Section of the Request for Grant form (Form 1001, versions prior to April 2009). This helped to ensure that the designation fees paid were properly entered in the books. If designation fees are not paid within the basic time limit, a communication under Rule 112(1) is issued.

In response to the communication under Rule 112(1), the applicant may request further processing in respect of the lost designation(s). However, no Rule 112(1) communication will be sent and no further processing can be requested with regard to designations in respect of which the applicant waived these rights by crossing the appropriate box on the Request for grant form or where the designation in question has been withdrawn.

For applicants taking part in the automatic debiting procedure, see also A-X, 7.2.

### 11.3.7 Amount payable

*Art. 6(2), 1<sup>st</sup> sentence, RFees*  
*Art. 8(2), 2<sup>nd</sup> sentence, RFees, old version*  
*Rule 39(2), old version*  
*Rule 112(1)*

If, given the amount payable under the time limit in question, the sum paid for designation fees during the periods under Rule 39(1) or Rule 135(1) does not cover all the Contracting States indicated in the Request for Grant form (Form 1001), and the payer failed to indicate for which Contracting States the fees are intended, then he is requested to indicate which States he wishes to designate, within a period stipulated by the EPO (see also A-III, 11.3.3). If he fails to comply in due time, then Art. 8(2) RFees applies: the fees are deemed to have been paid only for as many designations as are covered by the amount paid, in the order in which the Contracting States have been designated (see J 23/82, *mutatis mutandis*). The designation of Contracting States not covered by the fees are deemed withdrawn, and the applicant is notified of the loss of rights (see A-III, 11.3.4, paragraph 3, regarding the time at which loss of rights ensues).

### 11.3.8 Withdrawal of designation

*Art. 79(3)*  
*Rule 39(3) and (4), old versions*  
*Rule 15*

Subject to the final sentence of this paragraph, the designation of a Contracting State may be withdrawn by the applicant at any time up to the grant of the patent. The designation fee is not refunded when a designation is withdrawn. Withdrawal of the designation of all the Contracting States results in the application being deemed to be withdrawn and the applicant is notified accordingly. The designation of a Contracting State may not be withdrawn as from the time when a third party proves to the EPO that he has initiated proceedings concerning entitlement and up to the date on which the EPO resumes proceedings for grant.

The applicant may withdraw designations when filing the European application, for example to avoid overlapping prior national rights with the priority application according to Art. 139(3). Timely payment of designation fees for designations which have been withdrawn, will not cause those designations to be re-activated. Furthermore, no Rule 112(1) communication will be sent in respect of a failure to pay designation fees for any designation which has been withdrawn.

### 11.3.9 Euro-PCT applications entering the European phase before 1 April 2009

*Rule 159(1)(d)*

For Euro-PCT applications entering the European phase, the designation fees must be paid within 31 months of the filing or priority date, if the time limit specified in Rule 39(1) has expired earlier.

*Rule 160, old version*  
*Art. 153(2)*

Pursuant to Rule 160(2), the designation of any Contracting State for which no designation fee has been paid in time is deemed to be withdrawn. According to Rule 160(1), if no designation fee for the Euro-PCT application entering the European phase is paid at all within the basic period under Rule 159(1)(d), the European patent application (see Art. 153(2)) is deemed to be withdrawn. If the EPO finds that such deemed withdrawal of the European patent application or the designation of a Contracting State has occurred, it notifies the

applicant of this loss of rights according to Rule 112(1). In response to this communication, the applicant can request further processing according to Art. 121 and Rule 135 (see E-VII, 2.1).

For designation fees in relation to Euro-PCT applications entering the European phase, see also E-VIII, 2.1.3 and 2.3.11.

## **12. Extension of European patent applications and patents to States not party to the EPC**

### **12.1 General remarks**

At the applicant's request and on payment of the prescribed fee European patent applications (direct or Euro-PCT) and thus patents can be extended to European states for which an Extension Agreement with the EPO has become effective (extension states).

Extension may be requested for the following European states:

Bosnia and Herzegovina (BA)	since 1 December 2004
Montenegro	since 1 March 2010

The EPO's extension agreements with the **Republic of Slovenia** (entry into force: 1 March 1994), the **Republic of Romania** (15 October 1996), the **Republic of Lithuania** (5 July 1994), the **Republic of Latvia** (1 May 1995), the **Republic of Croatia** (1 April 2004), the **former Yugoslav Republic of Macedonia** (1 November 1997), **Albania** (1 February 1996) and the **Republic of Serbia** (1 November 2004) terminated when these countries acceded to the EPC with effect from 1 December 2002, 1 March 2003, 1 December 2004, 1 July 2005, 1 January 2008, 1 January 2009, 1 May 2010 and 1 October 2010 respectively. However, the extension system continues to apply to all European and international applications filed prior to those dates, and to all European patents granted in respect of such applications.

A request for extension to the above-mentioned states is deemed to be made with any European application filed after entry into force and before the termination of the respective Extension Agreements. This applies also to Euro-PCT applications provided that the EPO has been designated for a European patent **and** the extension state has been designated for a national patent in the international application. The request is deemed withdrawn if the extension fee is not paid within the prescribed time limit (see A-III, 12.2). It is by paying the extension fee that the applicant decides to extend his application to a certain extension state. The declaration in the appropriate section of the Request for Grant form (Form 1001) or of Form 1200 for entry into the European phase before the EPO, where the applicant is asked to state whether he intends to pay the extension fee, is merely for information purposes and intended to assist in recording fee payments.

A request for extension in respect of a divisional application (see A-IV, 1) is deemed to be made only if the respective request is still effective in the parent application when the divisional application is filed.

### 12.2 Time limit for payment of extension fee

Under the applicable national provisions of the extension states, the extension fee must be paid

- (i) for European patent applications, within six months of the date on which the European Patent Bulletin mentions the publication of the European search report, or
- (ii) for Euro-PCT applications, within the period for performing the acts required for entry of an international application into the European phase, or within six months of the date of publication of the international search report, whichever is the later.

If the fee for an extension state has not been paid within the corresponding period, the applicant can still pay the extension fee together with a 50% surcharge

- (a) within a grace period of two months from expiry of the basic period for payment; or
- (b) within two months of notification of a communication of loss of rights with regard to the omitted payment of a designation fee (see Notices from the EPO dated 2 November 2009, OJ EPO 2009, 603).

If the applicant fails to pay the extension fee during the basic and the grace period, the request for extension is deemed to be withdrawn. No communication of loss of rights is issued after expiry of either the basic or the grace period in these cases. However, a noting of loss of rights related to the failure to pay the designation fee pursuant to Rule 39(2) or 159(1)(d) will draw the applicant's attention to the lack of payment of the extension fee, where appropriate, triggering the time limit mentioned in item (b) above.

For applications in relation to which the (basic) period for payment of extension fees expired before 1 January 2010, the option of validly paying the fees plus surcharge during the grace period does not exist. In these cases the failure to pay in due time can only be remedied by filing a request for further processing according to Art. 121 and Rule 135, following a communication of loss of rights regarding the designation fee.

A request for re-establishment of rights according to Art. 122 and Rule 136 is not possible in respect of payment of the extension fee.

### 12.3 Withdrawal of extension

The request for extension may be withdrawn at any time. It will be deemed withdrawn if the European patent application or the Euro-PCT application is finally refused, withdrawn or deemed withdrawn. A separate communication is not issued to the applicant. Validly paid extension fees are not refunded.

### 12.4 Extension deemed requested

Extension is deemed to be requested in respect of all extension states (see, however, A-III, 12.1, 4th paragraph, regarding Euro-PCT applications), and this is indicated in the published application. These states, and those for which the extension fee has been paid, are indicated in the Register of European Patents and in the European Patent Bulletin.

### 12.5 National register

Extension states publish in their national register the relevant data relating to European patent applications and patents extending to their territory.

## 13. Filing and search fees

### 13.1 Payment of fees

The applicant is required to pay a filing fee and, subject to the exception mentioned below (see the note to point (iii) below), a search fee. The filing and search fees must be paid within the following periods:

- |       |   |  |
|-------|---|--|
| (i)   | where neither (ii) nor (iii) applies, within one month of the filing date of the European application   | <i>Rule 38</i>                         |
| (ii)  | for European divisional applications or European applications filed according to Art. 61(1)(b), within one month from the date of filing of the divisional or Art. 61(1)(b) application | <i>Rule 36(3)</i><br><i>Rule 17(2)</i> |
| (iii) | for Euro-PCT applications, within 31 months of the filing date or, where applicable, from the earliest claimed priority date*.  | <i>Rule 159(1)</i>                     |

\*Note that when a supplementary European search report is not prepared by the EPO (see B-II, 4.3), no search fee is required for the Euro-PCT application (Rule 159(1)(e)).

With regard to applications of types (i) and (ii), the EPO will check that these fees have been paid. If either fee is not paid on time, the application is deemed to be withdrawn. The EPO will notify the applicant of the loss of rights according to Rule 112(1); the applicant can respond by requesting further processing according to Art. 121 and Rule 135.

With regard to Euro-PCT applications (type (iii)), see E-VIII, 2.1.3.

*Rule 6(3) to (7)*

For the reduction of the filing fee under the language arrangements, see A-X, 9.2.1 and 9.2.2.

### **13.2 Additional fee (if application documents comprise more than thirty-five pages)**

*Rule 38(2) and (3)*

*Art. 2(1), No. 1a RFees*

This section relates only to applications filed and international applications entering the European phase on or after 1 April 2009 (see also the Notice from the EPO dated 26 January 2009, OJ EPO 2009, 118, and the supplement thereto, OJ EPO 2009, 338).

An additional fee is payable as part of the filing fee for European patent applications which are filed on or after 1 April 2009 and comprise more than thirty-five pages. The amount of the fee is calculated according to the number of pages over thirty-five. The language reduction under Rule 6(3) applies if the requirements of Rule 6(4), (6) and (7) have been met (see A-X, 9.2.1 and 9.2.2). The additional fee is payable within one month of the filing date of the application or of the date of filing a European divisional application or a European application according to Art. 61(1)(b). If the application is filed without claims or by reference to a previously filed application, the additional fee is payable within one month of filing the first set of claims or one month of filing the certified copy of the application referred to in Rule 40(3), whichever expires later. The additional fee is calculated on the basis of the pages of the description, claims, any drawings and one page for the abstract, in the language of filing. The pages of the request for grant (Form 1001) and those forming part of a sequence listing within the meaning of Rule 30(1) are not counted, provided the sequence listing contained in the description complies with WIPO Standard ST.25. If the application is filed by reference to a previously filed application, the pages of the certified copy, excluding those for the certification and for bibliographic data, are taken as the basis for the calculation. If the application is filed without claims, the additional fee takes account of the pages of the first set of claims filed.

For international (Euro-PCT) applications entering the European phase on or after 1 April 2009, the additional fee is payable as part of the filing fee within the 31-month period of Rule 159(1). It is calculated on the basis of the international application as published, any amendments under Article 19 PCT and one page for the abstract. If there is more than one page of bibliographic data, the further pages are not counted. The pages of the latest set of any amended documents (Article 34 PCT, amendments filed upon entry) on which European phase processing is to be based (Rule 159(1)(b)) will also be taken into account where available to the EPO by the date of payment of the additional fee within the thirty-one months. If the applicant intends pages of the international publication or of amendments to be replaced by pages of the latest set of amendments, and therefore to be excluded from the calculation, he must also, at the latest by the date of payment, identify these replacement pages and clearly indicate the pages which they are to replace. This information should preferably be given in the relevant section of the form for entry into the European phase



(Form 1200). Otherwise any new pages filed at this stage will be taken to be additional pages. Form 1200 is disregarded in the calculation of the additional fee.

*Example:*

International application, published in English, containing 100 pages:

abstract	1
description	50
claims	20
drawings	20
claims, Art. 19 PCT	9

On entry into European phase, within the 31-month period, 10 pages of amended claims are filed to replace previous pages of claims, as indicated by the applicant in Form 1200.

-> number of pages on which calculation is based: 100 - 20 (original claims) - 9 (Art. 19 PCT) + 10 (EP entry) - 35 (fee-exempt)

-> number of pages to be paid for: 46

Pages of amendments filed after the date of payment of the additional fee, in particular during the Rule 161(1) or Rule 161(2) period (see E-VIII, 3), are not taken into account. Consequently, if amendments are filed at this stage which reduce the number of pages already paid for, no refund will be made.

If the additional fee is not paid on time, the application is deemed to be withdrawn. The EPO will notify the applicant of the loss of rights according to Rule 112(1); the applicant can request further processing according to Art. 121 and Rule 135. The amount of the fee for further processing is computed according to the number of pages on file at expiry of the relevant period for which the additional fee, calculated as set out above, has not been paid. The amount of the fee for further processing in respect of the additional fee does not take into account the basic filing fee according to Art. 2(1), No. 1, RFees, where this was paid on time.

*Art. 2(1), No. 12 RFees*

### **13.3 Additional fee for divisional applications**

Regarding the additional fee payable as part of the filing fee for divisional applications of second or subsequent generations filed on or after 1 April 2014, see A-IV, 1.4.1.1, and the Notice from the EPO dated 8 January 2014, OJ EPO 2014, A22.

*Rule 38(4)*

*Art. 2(1), No. 1b  
RFees*

#### 14. Translation of the application

*Art. 14(2)*  
*Rule 6(1)*

There are three situations in which a translation of the European application will be required:

- (i) the European application was filed according to Art. 14(2) in a language which is not an official language of the EPO
- (ii) the European application was filed by reference to a previously filed application which is not in an official language of the EPO (Rule 40(3))
- (iii) the European divisional application was filed in the same language as the earlier (parent) application on which it is based, where this was not an official language of the EPO (Rule 36(2) - see A-IV, 1.3.3).

In all cases, a translation of the application must be filed at the EPO: in cases (i) and (ii) this must be done within two months of the date of filing according to Rule 6(1) (for type (i)) or Rule 40(3) (for type (ii)); in case (iii) it must be done within two months of the filing of the divisional application according to Rule 36(2).

*Art. 90(3)*  
*Rule 57(a)*

The EPO will check that this requirement has been complied with. If the applicant has not filed the translation, the EPO will invite him to rectify this deficiency under Rule 58 within a period of two months in accordance with the procedure explained in A-III, 16.

*Rule 58*

Failure to file the translation on time in response to the invitation under Rule 58 results in the application being deemed to be withdrawn according to Art. 14(2). The EPO will then notify the applicant of this loss of rights according to Rule 112(1). The above time limits for supplying the translation under Rule 40(3), Rule 6(1) and Rule 36(2) are all excluded from further processing by Rule 135(2), as is the time limit for rectification of the failure to file the translation under Rule 58. Consequently, further processing is not possible in this case. However, the applicant may request re-establishment according to Art. 122 and Rule 136 for failure to comply with the time limit under Rule 58.

#### 15. Late filing of claims

*Art. 80*  
*Rule 40(1)*

For the purposes of obtaining a date of filing it is not necessary for the European application to contain any claims. The presence of at least one claim is nonetheless a requirement for a European application according to Art. 78(1)(c), but a set of claims can be provided after the date of filing according to the procedure described below.

*Art. 90(3) and (5)*  
*Rule 57(c)*  
*Rule 58*

The EPO will check whether at least one claim is present in the application. If this is not the case, the EPO will issue an invitation under Rule 58 inviting the applicant to file one or more claims within a period of two months. If the applicant fails to do so within this period, the application is refused according to Art. 90(5). The applicant is notified of this decision according to Rule 111. Further processing for failure to

observe the time limit under Rule 58 is excluded by virtue of Rule 135(2). The applicant may, however request re-establishment according to Art. 122 and Rule 136 or may appeal.

Where the application documents as originally filed did not include at least one claim, the applicant may also file claims of his own motion after the date of filing, but before the EPO invites him to do so under Rule 58. In this case, no communication under Rule 58 will then be issued.

If the applicant does supply a set of claims in response to the invitation under Rule 58, the claims so filed must have a basis in the application documents (description and any drawings) provided on the date of filing (Art. 123(2)). This requirement will first be checked at the search stage (see B-XI, 2.2).

If the application was filed by means of a reference to a previously filed application in accordance with Rule 40(3) and the applicant indicated on the date of filing that the claims of the previously filed application were to take the place of claims in the application as filed (see A-II, 4.1.3.1), then, provided the previously filed application also contained claims on its date of filing, claims were present on the European date of filing and no communication under Rule 58 will be sent.

The above procedure also applies to divisional applications and applications filed in accordance with Art. 61(1)(b).

## 16. Correction of deficiencies

### 16.1 Procedure formalities officer

Where, during the examination for compliance with the requirements set out in earlier sections of this Chapter, it is noted that there are deficiencies which may be corrected, the formalities officer must give the applicant the opportunity to rectify each such deficiency within a specified period. A summary of the most common potential deficiencies at this stage of the procedure and the provisions governing their rectification is given below:

*Art. 90(3)*

A-III, 2	Representation	Rule 58
A-III, 3	Physical Requirements	Rule 58
A-III, 4	Request for grant	Rule 58
A-III, 5	Designation of inventor	Rule 60
A-III, 6	Claim to priority	Rule 52(3), Rule 59
A-III, 9	Payment of claims fees	Rule 45
A-III, 10	Abstract	Rule 58
A-III, 13	Filing fee, including any additional fee, search fee	Rule 112(1), Rule 135
A-III, 14	Translation of the application	Rule 58
A-III, 15	Late filing of claims	Rule 58

The formalities officer should in his first report to the applicant raise all the formal objections that become evident from a first examination of the application, except that, as noted in A-III, 3.2, the Receiving Section should not draw the attention of the applicant to deficiencies under Rule 46(2)(i) and (j) or question the inclusion of tables in the claims. It is likely that certain matters cannot be finally disposed of at this stage, e.g. filing of priority documents for which the period for filing has not expired, and further reports may be necessary. By way of exception, if the applicant is required to appoint a representative but has not done so, the formalities officer should in his first report deal only with this deficiency. Any request(s) for correction of other deficiencies will not be sent until a representative has been appointed, and will be sent to that representative.

### **16.2 Period allowed for remedying deficiencies**

*Rule 58*

The period for remedying the following deficiencies is two months from a communication pointing them out according to Rule 58:

- (i) non-appointment of a representative where the applicant has neither his residence nor principal place of business in a Contracting State - see A-III, 2 (regarding failure to file an authorisation where this is necessary, see A-VIII, 1.5 and the Decision of the President of the EPO dated 12 July 2007, Special edition No. 3, OJ EPO 2007, L.1);
- (ii) documents making up the application not complying with physical requirements (see A-III, 3);
- (iii) request for grant (with the exception of the priority criteria) not satisfactory (see A-III, 4);
- (iv) abstract not filed (see A-III, 10);
- (v) where required, translation of the application not filed (see A-III, 14)
- (vi) no claims (see A-III, 15).

*Art. 90(5)*

*Art. 14(2)*

If the above deficiencies under (i)-(iv) or (vi) are not rectified in time, the application is refused under Art. 90(5). If the deficiency under (v) is not rectified in time, the application is deemed to be withdrawn under Art. 14(2). According to Rule 135(2), further processing is excluded for all of the above losses of rights, which all arise from the failure to observe the time limit of Rule 58.

The following deficiencies are rectified under provisions other than Rule 58:

- (vii) non-payment of the claims fees (Rule 45 - see A-III, 9);

- (viii) priority document or file number of the previous application is missing (Rule 59 - see A-III, 6); and
- (ix) non-payment of filing fee, including any additional fee, and search fee (see A-III, 13).

According to Rule 45(2), the period for remedying deficiencies with regard to the payment of claims fees under (vii) is one month from a communication pointing out their non-payment. Failure to correct this deficiency in time leads to the claims in question being deemed to be abandoned under Rule 45(3). Further processing applies to this loss of rights.

*Rule 45*

Deficiencies under (viii) are to be corrected within a period to be specified by the EPO from a communication according to Rule 59 pointing out the failure to supply the certified copy and/or the file number of the priority document. This period under Rule 59 cannot be less than two months or more than four months (Rule 132(2)). Failure to correct this deficiency in time leads to the loss of the priority right. Further processing is excluded for this loss of rights according to Rule 135(2).

*Art. 90(5)*  
*Rule 59*

Failure to pay the filing, additional or search fee on time results in the deemed withdrawal of the application according to Art. 78(2). This loss of rights ensues directly on expiry of the applicable time limit (see A-III, 13). A deficiency under (ix) can be corrected by requesting further processing.

*Art. 78(2)*

Where appropriate, the Search Division is informed of any loss of rights.



## Chapter IV – Special provisions

### 1. European divisional applications (see also C-IX, 1)

#### 1.1 General remarks

A divisional application may be filed relating to any pending earlier European patent application. The term "earlier application" refers to the immediate parent application on which the divisional application is based. Where the earlier application is a Euro-PCT application, a divisional application can only be filed upon entry of the earlier application into the European phase (see E-VIII, 2.4.1).

*Art. 76*  
*Rule 36(1)*

The divisional application is accorded the same date of filing as the parent application and has the benefit of any right of priority of the parent application in respect of the subject-matter contained in the divisional application.

A European patent application may give rise to more than one divisional application. A divisional application may itself give rise to one or more divisional applications.

#### 1.1.1 Pendency of the earlier application

The parent application must be pending when a divisional application is filed. Reference is made in this regard to the observations made in decision G 1/09 as to what constitutes a pending application. In the case of an application being filed as a divisional application from an application which is itself a divisional application, it is sufficient that the latter is still pending at the filing date of the second divisional application. An application is pending up to (but **not** including) the date that the European Patent Bulletin mentions the grant of the patent (OJ EPO 2002, 112). It is not possible to validly file a divisional application when the parent application has been finally refused, withdrawn or is deemed to be withdrawn (see also the next two paragraphs).

If an application is deemed to be withdrawn due to the non-observance of a time limit (e.g. following failure to pay the filing fee (Art. 78(2)), to pay a renewal fee (Art. 86(1)), to pay the fee for grant and publishing or the claims fees, or to file the translation of the claims (Rule 71(7)) in due time), the application is no longer pending when the non-observed time limit has expired, unless the loss of rights, as communicated pursuant to Rule 112(1), is remedied. This may be effected either by means of an allowable request for further processing or, where further processing does not apply to the time limit in question, or the time limit for further processing has been missed, re-establishment of rights (which in the latter case is a request for re-establishment in respect of the period for further processing - see E-VII, 2). The application which has been deemed to be withdrawn is however not pending in the period for further processing or for filing a request for re-establishment of rights or in the period after which such

requests are filed in the event of such requests being refused (see J 4/11, reasons 21). Remedy of the loss of rights is also possible if the applicant considers that the finding of the EPO was inaccurate, by applying for a decision pursuant to Rule 112(2), whereupon either the competent EPO department shares his opinion and rectifies its decision or that department gives an unfavourable decision which is subsequently overturned on appeal. In this case the Office acknowledges that no loss of rights ever occurred and the application will have been pending throughout. If on the contrary the decision in effect confirms the loss of rights, the loss of rights will have occurred when the relevant time limit expired and the application ceased to be pending then. See J 4/11, reasons 22.

If an application has been refused and no appeal has yet been filed, the application is still pending within the meaning of Rule 36(1) until expiry of the time limit for filing the notice of appeal (Art. 108), and a divisional application can be validly filed until expiry of this period (see G 1/09). Where the applicant does file a notice of appeal, the decision to refuse cannot take effect until the appeal proceedings are over. As the provisions relating to the filing of divisional applications also apply in appeal proceedings (Rule 100(1)), a divisional application may be filed while such appeal proceedings are under way.

Furthermore, even where an application is still pending, while it is subject to a stay of proceedings in accordance with Rule 14(1) (see A-IV, 2.2), the filing of a divisional application is not possible because Rule 14(1) constitutes a *lex specialis* with regard to the right to file a divisional on a pending application provided for in Rule 36(1) (see J 20/05, and G 1/09, reasons 3.2.5).

The pendency of the earlier application is not a procedural deadline or time limit, which, in case of non-compliance, would lead to a loss of rights. Instead, it is a condition of a substantive nature for the filing of divisional applications (G 1/09, reasons 3.2.3). Therefore, the provisions on re-establishment of rights and further processing do not apply to the filing of divisional applications (J 10/01, reasons 15).

### 1.1.2 Sequences of divisional applications

A divisional application can also be an earlier application in the sense of Art. 76(1) for the purposes of a further divisional application. The characterising feature of a sequence of divisional applications each divided out from its predecessor is that each member of the sequence claims as date of filing the date of the root application in which the subject-matter divided out in sequences of divisional applications was first disclosed (G 1/05, G 1/06).

In a sequence of divisional applications, a first-generation divisional application is a divisional application based on an application which is not itself a divisional application, i.e. the root application. A



second-generation divisional application is a divisional application based on a first-generation divisional application; and so on.

### 1.1.3 Persons entitled to file a divisional application

Only the applicant on record may file a divisional application. This means that, in the case of a transfer of an application, a divisional application may only be filed by or on behalf of the new applicant if the transfer was duly registered and therefore effective vis-à-vis the EPO (Rule 22) at the filing date of the divisional application.

## 1.2 Date of filing of a divisional application; claiming priority

### 1.2.1 Date of filing

A European divisional application may be filed in respect of subject-matter which does not extend beyond the content of the parent application as filed. Provided this requirement is met, the divisional application is deemed to have been filed on the date of filing of the parent application and enjoys that application's priority (see A-IV, 1.2.2).

*Art. 76(1), 2nd sentence*

A divisional application filed in due form, i.e. meeting the requirements of Art. 80 and Rule 40(1) (see A-II, 4.1 *et seq.*), is accorded the same date of filing as the parent application. The question of whether it is confined to subject-matter contained in the parent application is not decided until the examination procedure (see C-IX, 1.4 *et seq.*).

*Art. 80  
Rule 40(1)*

Since Rule 40(1) does not require that a European application contain any claims on its date of filing, the same applies to a European divisional application. The applicant can file the claims after the filing of the divisional application according to the procedures detailed in A-III, 15. This may be done after the parent application is no longer pending, provided that the requirements of Rule 40(1) were satisfied with regard to the divisional while the parent application was still pending.

### 1.2.2 Priority claim of a divisional application

A priority claimed in the parent application also applies to the divisional application, provided that the parent application's priority has not been lost or withdrawn by the date the divisional application is filed; it is not necessary to claim it formally a second time. The priority claim can be withdrawn in respect of the divisional application (F-VI, 3.5, and E-VII, 6.2 and 6.3). However, this withdrawal will have no effect on the priority claim of the parent application. Similarly, the subsequent withdrawal of the priority claim of the parent application has no effect on the priority claim of the divisional application.

*Rule 53(2) and (3)*

The applicant may, if he so desires, claim fewer priorities in respect of the divisional application (where the parent application claims more than one priority - Art. 88(2)). To do so, he must file a clear and unambiguous withdrawal of the priority or priorities in question in respect of the divisional application (see the Notice from the EPO

dated 12 November 2004, point 4, OJ EPO 2004, 591). In the absence of such a withdrawal, all priorities which have not lapsed in respect of the parent application when the divisional is filed also remain valid with respect to the divisional application. Furthermore, in the absence of such a withdrawal, all such priority claims remain valid for the divisional, even if the applicant provides an incorrect or incomplete priority claim when filing the divisional application.

If a copy and any translation of the priority application have been filed in respect of the parent application before the divisional application is filed, it is not necessary to file the priority documents again in respect of the divisional application. The EPO makes a copy of these documents and places them in the file of the divisional application (see Decision of the President of the EPO dated 12 July 2007, Special edition No. 3, OJ EPO 2007, B.2).

If, when the divisional application is filed, the priority document has not been filed in respect of the parent application, it must be filed in respect of the divisional application and, if the priority of the parent application's remaining subject-matter is to be retained, in respect of the parent application also. The applicant can also inform the EPO, within the time limit set for filing priority documents in the divisional application proceedings, that he has in the meantime submitted these documents in respect of the parent application. If the subject-matter of the divisional application relates only to some of the priorities claimed in the parent application, priority documents in respect of the divisional application need be filed for those priorities only.

*Rule 52(2)*

This applies also as regards indicating the file number of the priority application. For the time limits for indicating the file number and for filing the priority documents, see A-III, 6.5, 6.5.3 and 6.7 *et seq.*

### **1.3 Filing a divisional application**

#### **1.3.1 Where and how to file a divisional application?**

*Rule 36(2)*

*Rule 35(1)*

A divisional application must be filed by delivery by hand, by post or by fax with the EPO in Munich, The Hague or Berlin. It may also be filed using the EPO Online Filing software (Art. 5 of the Decision of the President dated 26 February 2009, OJ EPO 2009, 182). The filing of a European divisional application with a national authority has no effect in law; the authority may however, as a service, forward the European divisional application to the EPO. If a competent national authority chooses to forward the application, it is not deemed received until the documents are filed at the EPO.

The divisional application may be filed by reference to the earlier application from which it derives (the parent application). The procedures are as provided for in Rule 40(1)(c), (2) and (3) (see A-II, 4.1.3.1). It will not be necessary for the applicant to file a copy or translation of the previous (parent) application according to Rule 40(3), provided that the parent application was a European

application or an international one filed with the EPO as receiving office under the PCT, since these will already be available to the EPO in the file of the previous (parent) application. If the parent application was a Euro-PCT application filed under the PCT at a receiving office other than the EPO, a certified copy will be required.

### 1.3.2 Request for grant

The request for grant of a patent must contain a statement that a divisional application is sought and state the number of the parent application. If the request is deficient, as can arise if there is no indication that the application constitutes a divisional application, although some of the accompanying documents contain an indication to that effect, or if the number is missing, the deficiency may be corrected in the manner indicated in A-III, 16.

*Rule 41(2)(e)*

### 1.3.3 Language requirements

As indicated in A-VII, 1.3, a divisional application must be filed in the language of the proceedings of the parent application. Alternatively, if the earlier (parent) application was filed in a language other than an official language of the European Patent Office, the divisional application may be filed in that language. In this case a translation into the language of the proceedings for the earlier application shall then be filed within two months of the filing of the divisional application (see A-III, 14).

*Rule 36(2)*

### 1.3.4 Designation of Contracting States

All Contracting States designated in the earlier application at the time of filing a European divisional application, are deemed to be designated in the divisional application (see also G 4/98). If no designations have been withdrawn in respect of the parent application, then all Contracting States adhering to the EPC at the date of filing of the parent are automatically designated in the divisional application when it is filed. Conversely, Contracting States, the designations of which have been withdrawn in respect of the parent application at the time of filing the divisional application, cannot be designated in respect of the divisional application.

*Art. 76(2)*  
*Rule 36(4)*

If the parent application was filed before 1 April 2009, and the time limit for payment of the designation fees has not yet expired for the parent application when the divisional application is filed, and no designations have been withdrawn in respect of the parent application, then all Contracting States adhering to the EPC at the date of filing of the parent are automatically designated in the divisional application when it is filed. Conversely, Contracting States, the designations of which have been withdrawn or deemed to be withdrawn in respect of the parent application at the time of filing the divisional application, cannot be designated in respect of the divisional application.

The flat designation fee payable for divisional applications filed on or after 1 April 2009 does not cover Contracting States the designations

of which have been withdrawn or deemed to be withdrawn at the time of filing the divisional application.

### 1.3.5 Extension states

All extension states designated in the earlier application at the time of filing of a European divisional application are deemed to be designated in the divisional application. For more details regarding the designation of these states, see A-III, 12.1.

## 1.4 Fees

### 1.4.1 Filing, search and designation fee(s)

The filing fee and search fee for the divisional application must be paid within one month after it is filed (basic time limit). For the additional fee due for any pages in excess of thirty-five, see A-III, 13.2. The designation fee(s) must be paid within six months of the date on which the European Patent Bulletin mentions the publication of the European search report drawn up in respect of the divisional application.

The search fee must be paid even if a further search fee has already been paid under Rule 64(1) in respect of the search report on the parent application for the part of the application which was lacking in unity and which is now the subject of the divisional application (for reimbursement of the search fee see A-IV, 1.8).

If, within the applicable time limit the filing, search or designation fees have not been paid, the application is deemed to be withdrawn. The EPO informs the applicant of these losses of rights by issuing a communication under Rule 112(1). The applicant can request further processing according to Art. 121 and Rule 135.

For divisional applications filed before 1 April 2009, see for the deemed withdrawal of single designations or of the application and applicable remedies A-III, 11.3.2 and 11.3.4.

#### 1.4.1.1 Additional fee for divisional applications of second or subsequent generations

An additional fee is payable as part of the filing fee for divisional applications of second or subsequent generations filed on or after 1 April 2014 (see the Notice from the EPO dated 8 January 2014, OJ EPO 2014, A22). The amount of the fee varies depending on the generation to which the divisional application filed belongs (see A-IV, 1.1.2). First-generation divisional applications are not subject to the additional fee. From the second to the fifth generation the amount of the fee grows progressively. For the fifth and subsequent generations it becomes a flat fee (Art. 2(1), No. 1b RFees).

*Rule 36(3) and (4)  
Art. 79(2)*

*Rule 36(3) and (4)*

*Rule 38  
Art. 2(1), No. 1b  
RFees*

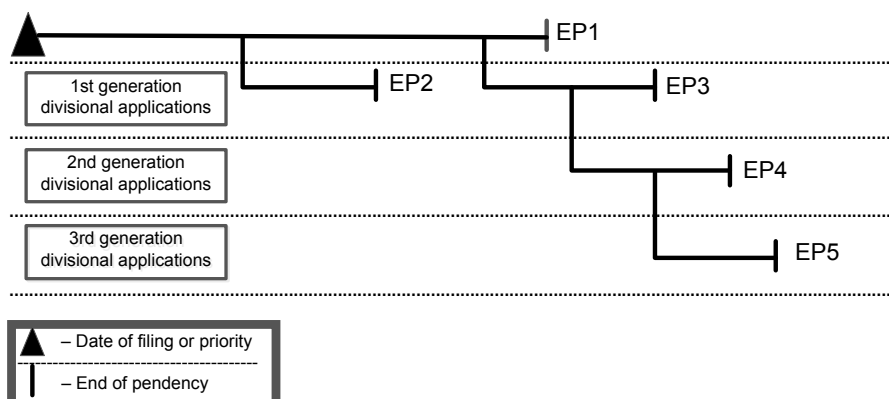
**Example:**

In this example, no additional fee would be due in respect of EP2 and EP3, as they are first-generation divisional applications. The amount of the additional fee for second-generation divisional applications would apply to EP4, and the amount for third-generation divisional applications would apply to EP5.

The additional fee is part of the filing fee for divisional applications of second and subsequent generations. Therefore, it must be paid within the same period as the filing fee, and the same provisions apply in case of non-payment in due time (see A-IV, 1.4.1). Likewise, the reduction of the filing fee under the language arrangements applies to this additional fee, provided that the requirements laid down in Rule 6(4) to (7) are complied with (see A-X, 9.2.1 and 9.2.2).

**1.4.2 Claims fees**

If, at the time of filing the first set of claims, the divisional application comprises more than fifteen claims, a claims fee is payable in respect of each claim over and above that number (see A-III, 9). Claims fees are payable even if in the parent application they were paid in respect of claims relating to the subject-matter now the subject of the divisional application (see A-III, 9).

*Rule 45(1)*

**1.4.3 Renewal fees**

For the divisional application, as for any other European patent application, renewal fees are payable to the EPO. They are due in respect of the third year and each subsequent year, calculated from the date of filing of the parent application. Pursuant to Art. 76(1), the date of filing the parent application is also the date from which the time limits for payment of the renewal fees for the divisional application (Art. 86(1)) are calculated. If, when the divisional application is filed, renewal fees for the parent application have already fallen due, these renewal fees must also be paid for the divisional application and fall due when the latter is filed. The period for payment of these fees is four months after the filing of the divisional application. If not paid in due time, they may still be validly paid within six months of the date on which the divisional application was filed, provided that at the same

*Art. 86(1)*

*Art. 76(1)*

*Rule 51(3)*

*Art. 2(1), No. 5 RFees*

time the additional fee of 50% of the renewal fees paid late is paid. The same applies if on the date of filing of the divisional application a further renewal fee in addition to those to be made good falls due, or a renewal fee falls due for the first time.

*Rule 51(3)*

*Art. 2(1), No. 5 RFees*

If, within the four-month period referred to above, a further renewal fee falls due or a renewal fee falls due for the first time, it may be paid without an additional fee within that period. It may otherwise still be validly paid within six months of the due date, provided that at the same time the additional fee of 50% of the renewal fee paid late is paid. When calculating the additional period the principles developed by the Legal Board of Appeal should be applied (see J 4/91).

Further processing for failure to pay renewal fees on time is excluded by virtue of Rule 135(2). However, re-establishment is possible. In the case of applications for re-establishment of rights in respect of renewal fees falling due on filing of the divisional or within the four-month period laid down in Rule 51(3), second sentence, the one-year period prescribed by Rule 136(1) starts to run only after the six months under Rule 51(2) have expired.

*Example:*

25.03.2008:	date of filing of parent application;
11.01.2011:	filing of divisional application and due date of renewal fee for the third year;
31.03.2011:	due date of renewal fee for the fourth year;
11.05.2011:	expiry of four-month period under Rule 51(3);
11.07.2011:	expiry of six-month period under Rule 51(2) in respect of the renewal fee for the third year;
30.09.2011:	expiry of six-month period under Rule 51(2) in respect of the renewal fee for the fourth year;
11.07.2012:	expiry of one-year period under Rule 136(1) in respect of the renewal fee for the third year;
01.10.2012:	expiry of one-year period under Rule 136(1) in respect of the renewal fee for the fourth year (extended under Rule 134(1)).

For other examples see A-X, 5.2.4.

### **1.5 Designation of the inventor**

*Rule 60(2)*

The provisions of A-III, 5.5 apply with regard to the designation of the inventor, except that, where the designation of the inventor has not been provided or is deficient (i.e. it does not comply with Rule 19), the applicant will be invited to provide or correct it within a period to be specified by the EPO, which must be a minimum of two months (Rule 132(2)). The divisional application requires a separate designation, independent of the parent application on which it is based.

## 1.6 Authorisations

The provisions of A-VIII, 1.5 and 1.6 apply with regard to authorisations in respect of the divisional application. If, according to these provisions, the representative has to file an authorisation, he may act on the basis of an individual authorisation filed in respect of the parent application only if it expressly empowers him to file divisional applications.

## 1.7 Other formalities examination

Other than for matters referred to in A-IV, 1.1 to 1.6, the formal examination of divisional applications is carried out as for other applications. The provisions of Rule 30 apply with regard to divisional applications relating to nucleotide or amino acid sequences filed after 1 January 1993 (see A-IV, 5).

## 1.8 Search, publication and request for examination of divisional applications

Divisional applications are searched, published and examined in the same way as other European patent applications. The search fee is refunded if the conditions of Art. 9(2) of the Rules relating to Fees are met (see the Notice from the President of the EPO dated 13 December 2001, OJ EPO 2002, 56, for divisional applications filed before 1 July 2005, the Decision of the President of the EPO dated 14 July 2007, Special edition No. 3, OJ EPO 2007, M.2, for divisional applications filed on or after 1 July 2005 for which the search is completed before 1 April 2009, the Decision of the President of the EPO dated 22 December 2008, OJ EPO 2009, 96, for divisional applications for which the search is completed on or after 1 April 2009 but before 1 July 2010, and the Decision of the President of the EPO dated 24 March 2010, OJ EPO 2010, 338, for divisional applications for which the search is completed on or after 1 July 2010). Here, the term "filed" refers to the date on which the divisional application is received at the EPO, not the filing date, which is the same as the filing date for the parent application (Art. 76(1)). The time limit for filing the request for examination begins to run with the date of mention of the publication of the search report concerning the divisional application.

## 2. Art. 61 applications and stay of proceedings under Rule 14

### 2.1 General

It may be adjudged by decision of a court or competent authority (hereinafter "court") that a person referred to in Art. 61(1), other than the registered applicant, is entitled to the grant of a European patent. This third party may, within three months after the decision has become final, provided that the European patent has not yet been granted, in respect of those Contracting States designated in the European patent application in which the decision has been taken or recognised or has to be recognised on the basis of the Protocol on Recognition annexed to the European Patent Convention:

*Art. 61(1)*  
*Rule 16*

- (i) prosecute the application as his own application in place of the applicant (see A-IV, 2.4 and 2.7);

*Art. 61(1)(a)*



*Art. 61(1)(b)* (ii) file a new European patent application in respect of the same invention (see A-IV, 2.5 and 2.7); or

≡

*Art. 61(1)(c)* (iii) request that the application be refused (see A-IV, 2.6 and 2.7).

≡

In a case where the application is no longer pending due to its having been withdrawn, refused or being deemed to be withdrawn, the third party can still file a new European patent application in respect of the same invention, in accordance with Art. 61(1)(b) (see G 3/92).

## **2.2 Stay of proceedings for grant**

≡

*Rule 14(1)*

If a third party provides proof to the EPO that he has opened proceedings against the applicant for the purpose of seeking a judgement that he is entitled to the grant of the European patent the EPO will stay the proceedings for grant unless the third party communicates to the EPO in writing his consent to the continuation of such proceedings. This consent is irrevocable.

≡

≡

|

≡

≡

Proceedings for grant may not be stayed before the publication of the European patent application. In the case of a Euro-PCT application proceedings may only be stayed after expiry of the time limit for entry into the European phase.

≡

≡

|

Furthermore, Rule 14(1) only refers to national entitlement proceedings which result directly, i.e. generally and automatically, in decisions mentioned in Art. 61(1) and it does not refer to proceedings initiated before a court of a non-Contracting State (J 6/03, r.21). Jurisdiction and the recognition of decisions regarding the right to the grant of a European patent for EPC Contracting States are governed by the Protocol on Recognition, which under Art. 164(1) is an integral part of the EPC. Arbitration awards may be recognised, provided that they may automatically be recognised by all designated Contracting States, e.g. pursuant to the New York Convention on the Recognition and Enforcement of Foreign Arbitral Awards of 10 June 1958.

|

The dates on which proceedings are stayed and resumed will be entered in the European Patent Register (Rule 143(1)(s)). They will also be communicated to the parties.

|

For the stay of opposition proceedings, see D-VII, 4.1.

|

### **2.2.1 Responsible department**

*Art. 20*

Sole responsibility for procedures where the applicant is not entitled lies with the Legal Division of the EPO (Decision of the President of the EPO dated 21 November 2013, OJ EPO 2013, 600).

|

|

|

|

|

|

|

### **2.2.2 Date of the stay of proceedings**

A stay of proceedings under Rule 14(1) takes immediate effect as from the date the EPO is provided with satisfactory evidence that national proceedings have been instituted against the applicant seeking a decision within the meaning of Art. 61(1) (J 9/12).

|

|

|

|

|

|

|

|

|



The requirements for effectively initiating court proceedings are governed by national law (J 7/00).

### **2.2.3 Legal nature and effects of the stay**

The stay of proceedings is a preliminary procedural measure sui generis which is justified as a preventive measure to preserve the third party's possible rights to the patent in dispute and which takes immediate effect (J 28/94, J 15/06). In particular, the stay of the grant proceedings is ordered by a communication of the EPO without having heard the applicant. However, the applicant may, in view of the said communication, request the issuance of an appealable decision.

Stay of proceedings implies that the legal status quo existing at the time of the suspension is maintained, i.e. neither the EPO nor the parties can validly perform any legal acts while proceedings are suspended (J 38/92). In particular, the applicant is not allowed to withdraw either the European patent application or the designation of any Contracting State (Rule 15). Likewise, no divisional application can be filed during the stay of proceedings (J 20/05 and J 9/12).

An automatic debit order ceases to be effective on the day on which a stay of the proceedings under Rule 14 takes effect (see Point 13(e) AAD, Annex A.1 to the ADA, Supplementary publication 4, OJ EPO 2014, 24). Therefore, after resumption of proceedings a new automatic debit order is needed, if the applicant wishes to continue using the automatic debiting procedure.

### **2.2.4 Interruption of time limits**

The time limits in force at the date of stay other than time limits for payment of renewal fees are interrupted by such stay. The time which has not yet elapsed begins to run as from the date on which proceedings are resumed. However, the time still to run after the resumption of the proceedings may not be less than two months.

*Rule 14(4)*

Example: The six-month time limit under Art. 94(1) and Rule 70(1) begins on 1 July 2008. Proceedings are stayed on 23 September 2008 and resumed on 4 August 2009. The last day of the period already elapsed is 22 September 2008. The time which has not elapsed is therefore 8 days and 3 months, begins on 4 August 2009 and ends on 11 November 2009.

### **2.2.5 Resumption of the proceedings for grant**

The date of resumption of proceedings, as well as the legal basis for the resumption is to be communicated to the third party and the applicant.

*Rule 14(3)*

### 2.2.5.1 Resumption after final decision in entitlement proceedings

Rule 14(2)

Grant proceedings will be resumed where evidence is provided that a final decision within the meaning of Art. 61(1) has been taken, unless a new European patent application under Art. 61(1)(b) has been filed for all the designated Contracting States. If the decision is in favour of the third party, the proceedings may not be resumed earlier than three months after the decision has become final, unless the third party requests the resumption.

### 2.2.5.2 Resumption regardless of the stage of entitlement proceedings

Rule 14(3)

The Legal Division may also order the resumption of grant proceedings regardless of the stage reached in the proceedings against the applicant. In this case, it is at the discretion of the Legal Division to decide whether the proceedings are to be continued. This discretion is to be exercised with due regard to the interests of the parties. In particular, the outcome of the court proceedings in the first instance and the duration of the stay of proceedings before the EPO are to be taken into consideration, as well as an evident abuse of proceedings, e.g. in the form of delaying tactics.

### 2.3 Limitation of the option to withdraw the European patent application

Rule 15

As from the time when a third party proves to the EPO that he has initiated proceedings concerning entitlement (see A-IV, 2.2) and up to the date on which the EPO resumes the proceedings for grant (see A-IV, 2.2.5), neither the European patent application nor the designation of any Contracting State may be withdrawn.

### 2.4 Prosecution of the application by a third party

Art. 61(1)(a)

If a third party wishes to avail himself of the possibility open to him under Art. 61(1)(a) (see A-IV, 2.1(i)), he must declare his intention in writing to the EPO in due time. He then takes the place of the erstwhile applicant. The proceedings for grant are continued from the point reached when the third party filed his declaration, or when they were stayed (see A-IV, 2.2).

### 2.5 Filing a new application

Art. 61(1)(b)

Art. 76(1)

A new European patent application under Art. 61(1)(b) must be filed in paper or electronic form at The Hague, Munich or Berlin offices of the EPO. It is not possible to file an application according to Art. 61(1)(b) with the competent authorities of a Contracting State.

The new application is in many other respects treated as a European divisional application and corresponding provisions apply. In particular, the following provisions relating to divisional applications apply *mutatis mutandis*:

- (i) accordance of the date of filing of the earlier application and entitlement to priority date – see A-IV, 1.2; *Art. 61(2)*
- (ii) information in the request for grant – see A-IV, 1.3.2;
- (iii) filing, search, designation and claims fees – see A-IV, 1.4.1 and 1.4.2; *Rule 17(2) and (3)*  
*Rule 45(1)*
- (iv) designation of inventor – see A-IV, 1.5.
- (v) language requirements – see A-IV, 1.3.3.

However, arrangements for renewal fees are different. For the year in which the new application is filed and for the years beforehand, no renewal fees are payable. *Rule 51(6)*

In other respects the formal examination is carried out as for other applications.

If it is adjudged that a third party is entitled to the grant of a European patent for only some of the Contracting States designated in the earlier application, and the third party files a new application for these States, for the remaining States the earlier application continues to be in the name of the earlier applicant.

The earlier application is deemed to be withdrawn on the date of filing of the new application for the Contracting States designated therein in which the decision has been taken or recognised. *Rule 17(1)*

## ⚡ **2.6 Refusal of the earlier application**

If the third party requests under Art. 61(1)(c) that the earlier application be refused, the EPO must accede to this request. The decision is open to appeal (Art. 106(1)). *Art. 61(1)(c)*

## ⚡ **2.7 Partial transfer of right by virtue of a final decision**

If by a final decision it is adjudged that a third party is entitled to the grant of a European patent in respect of only part of the matter disclosed in the European patent application, Art. 61 and Rules 16 and 17 apply to such part. *Rule 18(1)*

## **3. Display at an exhibition**

### **3.1 Certificate of exhibition; identification of invention**

Where an applicant states when filing his application that the invention which is the subject of the application has been displayed at an official or officially recognised international exhibition falling within the terms of the Convention on international exhibitions, he must file a certificate of exhibition within four months of the filing of the European patent application. The exhibitions recognised are published in the Official Journal. The certificate, must: *Art. 55(1)(b) and (2)*  
*Rule 25*

- (a) have been issued during the exhibition by the authority responsible for the protection of industrial property at that exhibition;
- (b) state that the invention was exhibited at the exhibition;
- (c) state the opening date of the exhibition and the date of the first disclosure, if different from the opening date of the exhibition;
- (d) be accompanied by an identification of the invention, duly authenticated by the above-mentioned authority.

### 3.2 Defects in the certificate or the identification

The Receiving Section acknowledges receipt of the certificate and identification of the invention. The Receiving Section draws the applicant's attention to any manifest defects in the certificate or the identification in case it is possible to rectify the deficiencies within the four-month period allowed. The applicant is notified according to Rule 112(1) if the certificate or identification is not furnished within the time allowed. The applicant may request further processing in respect of this loss of rights according to Art. 121 and Rule 135.

## 4. Applications relating to biological material

### 4.1 Biological material; deposit thereof

*Rule 26(3)*

In accordance with Rule 26(3), "biological material" means any material containing genetic information capable of reproducing itself or being reproduced in a biological system.

*Rule 31(1)(c) and (d)*  
*Rule 31(2)*

Where in relation to an application concerning biological material an applicant states that he has deposited in accordance with Rule 31(1)(a) the biological material with a depositary institution recognised for the purposes of Rules 31 and 34, he must, if such information is not contained in the application as filed, submit the name of the depositary institution and the accession number of the culture deposit and, where the biological material has been deposited by a person other than the applicant, the name and address of the depositor, within whichever of the following periods is the first to expire:

*Rule 31(2)(a)*

- (i) within a period of sixteen months of the date of filing of the European patent application or the date of priority, this time limit being deemed to have been met if the information is submitted before completion of the technical preparations for publication of the European patent application;

*Rule 31(2)(b)*

- (ii) if a request for early publication of the application according to Art. 93(1)(b) is submitted, up to the date of such submission; or

*Rule 31(2)(c)*

- (iii) if it is communicated that a right to inspection of the files pursuant to Art. 128(2) exists, within one month of such communication.

The above time limit according to Rule 31(2) is excluded from further processing by Rule 135(2). Furthermore, Art. 122 is also not applicable, because a lack of disclosure cannot be remedied by way of re-establishment under Art. 122 (see the Notice from the EPO dated 7 July 2010, OJ EPO 2010, 498).

Moreover, when the depositor and applicant are not identical, the same time limit applies for submitting a document satisfying the EPO that the depositor has authorised the applicant to refer to the deposited biological material in the application and has given his unreserved and irrevocable consent to the deposited material being made available to the public in accordance with Rule 33(1) and (2) or Rule 32(1). The depositor's authorisation for the applicant to refer to the deposit and his consent to the material being made available to the public must have existed as from the filing date of the application in question. For a recommended wording for this declaration, see paragraph 3.5 of the above-mentioned Notice from the EPO.

*Rule 31(1)(d)*

Note, however, that where the depositor is one of several applicants the document referred to in Rule 31(1)(d) is not required (see the above-mentioned Notice). For Euro-PCT applications where the depositor is an applicant, but only in respect of a designated office other than the EPO (e.g. the inventor for the designation of the USA), the document referred to above is required and must be provided to the International Bureau before completion of the technical preparations for international publication (see the above-mentioned Notice from the EPO).

The depositary institution must be one appearing on the list of depositary institutions recognised for the purposes of Rules 31 to 34, as published in the Official Journal of the EPO. This list includes the depositary institutions, especially the International Depositary Authorities under the Budapest Treaty. An up-to-date list is regularly published in the Official Journal.

*Rule 33(6)*

#### **4.1.1 New deposit of biological material**

If biological material deposited according to Rule 31 ceases to be available from the recognised depositary institution, an interruption in availability shall be deemed not to have occurred if:

*Rule 34*

- (i) a new deposit of that material is made in accordance with the Budapest Treaty
- (ii) a copy of the receipt of that new deposit issued by the depositary institution is forwarded to the EPO within four months of the date of the new deposit, stating the number of the European patent application or patent.

The non-availability may occur because, for example:

- (a) the material has degraded such that it is no longer viable, or

- (b) the authority with which the original deposit was made no longer qualifies for that kind of material, either under the Budapest Treaty or under bilateral agreements with the EPO.

In either case (a) or (b) above, a new deposit must be made within three months of the depositor's being notified of the non-availability of the organism by the depositary institution (Art. 4(1)(d) Budapest Treaty). This is subject to the exception, where:

- the non-availability of the deposit is for the above reason (b), and
- the depositor does not receive the above notification from the depositary institution within six months after the date on which it is published by the International Bureau that the depositary institution is no longer qualified in respect of the biological material in question.

In this exceptional case, the new deposit must be made within three months from the date of the said publication by the International Bureau (Art. 4(1)(e) Budapest Treaty).

If, however, the original deposit was not made under the Budapest Treaty, but rather at a depositary institution recognised by the EPO by virtue of a bilateral agreement, the above-mentioned six-month period is calculated from the date when the EPO publishes the fact that the depositary institution in question is no longer qualified to accept deposits of the biological material in question under that bilateral agreement.

#### **4.1.2 The application was filed by reference to a previous application**

Where the application was filed by reference to a previously filed application in accordance with the procedures described in A-II, 4.1.3.1, and the previously filed application referred to already satisfied the requirements of Rule 31(1)(b) and (c) on its date of filing, these requirements will also be satisfied in respect of the European application.

If the information on the deposited biological material present in the previously filed application as filed does not satisfy Rule 31(1)(c), the EPO will not know this until the applicant files the certified copy and any required translation of the previously filed application (at the latest within two months of the date of filing – Rule 40(3)). Even where the certified copy and any translation required are filed up to two months from the date of filing, if the requirements of Rule 31(1)(c) are not satisfied, the time limit for rectification of this deficiency according to Rule 31(2) is unaffected (see A-IV, 4.2).

## 4.2 Missing information; notification

When the Receiving Section notices that the information required under Rule 31(1)(c) (indication of the depositary institution and the accession number of the culture deposit) or the information and the document referred to in Rule 31(1)(d) (authorisation to refer to the deposit and the consent to it being made available) is not contained in or has not yet been submitted with the application, it should notify the applicant of this fact as this information can only be validly submitted within the time limits specified in Rule 31(2). In the case of missing information pursuant to Rule 31(1)(c), the deposit must be identified in the patent application as filed in such a way that the later submitted accession number can be traced back without ambiguity. This can normally be done by indicating the identification reference given by the depositor within the meaning of Rule 6.1(a)(iv) of the Budapest Treaty (see G 2/93). The applicant is also informed when a deposit with a recognised depositary institution is referred to but no receipt from the depositary institution has been filed (the applicant is advised to provide this receipt when filing the application, if possible - see the Notice from the EPO dated 7 July 2010, OJ EPO 2010, 498). Any further action is a matter for the Examining Division. See also F-III, 6, in particular F-III, 6.3(ii), as regards the Examining Division's treatment of applications relating to biological material. The time limit according to Rule 31(2) for supplying the information required by Rule 31(1)(c) and (d) is excluded from further processing by Rule 135(2).

*Art. 97(2)*

*Rule 31*

*Art. 83*

## 4.3 Availability of deposited biological material to expert only

Under Rule 32(1)(a) and (b), until the date on which the technical preparations for publication of the application are deemed to have been completed, the applicant may inform the EPO that, until the publication of the mention of the grant of the European patent or, where applicable, for twenty years from the date of filing if the application has been refused or withdrawn or is deemed to be withdrawn, the availability referred to in Rule 33 is to be effected only by the issue of a sample to an expert.

*Rule 32(1)*

The above communication must take the form of a written declaration addressed to the EPO. This declaration may not be contained in the description and the claims of the European patent application, but may be given in the appropriate section of the Request for Grant form (Form 1001).

If the declaration is admissible, it is mentioned on the front page when the European patent application is published (see also A-VI, 1.3).

For Euro-PCT applications published in the international phase in an official language of the EPO, the applicant must request the expert solution to the International Bureau before completion of the technical preparations for international publication, preferably using Form PCT/RO/134 (see the Notice from the EPO dated 7 July 2010, OJ EPO 2010, 498). For Euro-PCT applications not published in the international phase in an official language of the EPO, the applicant

may request the expert solution under Rule 32(1) before completion of the technical preparations for publication of the translation of the international application required under Rule 159(1)(a) (see the above-mentioned Notice from the EPO).

*Rule 32(2)* If the applicant duly informs the EPO under Rule 32(1), the biological material is issued only to an expert recognised by the President of the EPO or approved by the applicant.

*Rule 33(6)* The list of recognised microbiological experts, giving their particulars and their fields of activity, is published in the Official Journal (see OJ EPO 1992, 470).

### **5. Applications relating to nucleotide and amino acid sequences**

*Rule 57(j)*  
*Rule 30(1) and (2)* If nucleotide and amino acid sequences within the meaning of Rule 30(1) are disclosed in the European patent application, they are to be represented in a sequence listing which conforms to WIPO Standard ST.25. The sequence listing should, where it is filed together with the application, be placed at the end of the application (see WIPO Standard ST.25, point 3). The sequence listing must be filed in electronic form. Where the European patent application is filed online, the electronic form is to be attached. Data in electronic form must comply with WIPO Standard ST.25, paragraph 39ff. Where the sequence listing is in addition voluntarily filed on paper, the sequence listing on paper must be identical to the information in electronic form. In this case, the applicant or his representative must submit a statement to that effect accompanying the electronic form in accordance with Rule 30(1) and WIPO Standard ST.25. See the Decision of the President of the EPO dated 28 April 2011, OJ EPO 2011, 372 and the Notice from the EPO dated 18 October 2013, OJ EPO 2013, 542. Where a sequence listing is filed or corrected after the filing date, the applicant is required to submit a statement that the sequence listing so filed or corrected does not include matter which goes beyond the content of the application as filed.

For applications referring to sequences which belong to the prior art see F-II, 6.1.

*Art. 90(3)*  
*Rule 30(3)* The Receiving Section will inform the applicant of any deficiencies as to the sequence listing or as to the necessary statements and invite him to remedy the deficiencies and pay a late furnishing fee within a non-extendable period of two months. If the requirements of Rule 30 in conjunction with the Decision of the President of the EPO dated 28 April 2011 are not complied with in due time, where appropriate following the invitation to do so from the Receiving Section, which includes the payment of the late furnishing fee, the application will be refused according to Rule 30(3). This also applies if a sequence listing is subsequently filed in electronic form, i.e. in text format (TXT) but still contains deficiencies with respect to the Standard. Such deficiencies



will not prompt the EPO to issue another invitation under Rule 30(3), triggering a new period of two months, unless the previous invitation did not draw the applicant's attention to such remaining deficiencies (see J 7/11).

The applicant may request further processing of the application.

*Art. 121*  
*Rule 135*

### **5.1 Sequence information filed under Rule 56**

If the application as originally filed does not disclose any sequences, such that the EPO cannot be aware of any deficiency, then no communication according to Rule 30(3) or Rule 56(1) will be sent to the applicant. In such cases, the applicant may file the missing parts of the description relating to sequences of his own motion within two months of the date of filing according to Rule 56(2) (see A-II, 5.2). According to Rule 57(j), any sequence information thus filed will be checked for compliance with Rule 30(1) in conjunction with the rules laid down by the President of the EPO, including the requirement to furnish the listing in electronic form and, where applicable, to furnish the statement of identity of the electronic listing with the written listing.

If the sequence information thus filed does not conform to the requirements of Rule 30(1) in conjunction with the rules laid down by the President of the EPO, then a communication under Rule 30(3) is sent to the applicant requesting correction (see A-IV, 5).

If, on the other hand, the sequence information thus filed already conforms to the requirements of Rule 30(1), no Rule 30(3) communication will be sent.

The above applies regardless of whether or not the late-filed parts of the description result in a change of the date of filing (see A-II, 5.3) or if the late-filed missing parts can be based on the claimed priority, allowing the original date of filing to be maintained (see A-II, 5.4). If, however, the late-filed parts of the description result in a change of the filing date, any communication according to Rule 30(3) which might be required will only be sent after the one-month period for the withdrawal of the late-filed parts has expired without the applicant having withdrawn them (see A-II, 5.5).

Where the application as filed contains a sequence listing which does not contain all the sequences disclosed in the application documents, the sequence listing, due to this incompleteness, cannot be considered as complying with WIPO Standard ST.25. Hence, the applicant will be invited under Rule 30 to file a standard compliant sequence listing and to pay the late furnishing fee.

In the case where the applicant inserts a sequence listing which conforms to the requirements of Rule 30(1) into the description as a late-filed part of the description according to Rule 56, the sequence listing so added is considered part of the description on the date of

filing (regardless of whether or not this has changed). That is to say, in this case Rule 30(2) does not apply.

## **5.2 Sequence listings of an application filed by reference to a previously filed application**

Where the application is filed by reference to a previously filed application (see A-II, 4.1.3.1), and that previously filed application contained sequence listings on its date of filing, then those sequence listings form part of the application as originally filed. This is subject to the exception that, where the sequences only appear in the claims and not in the description or drawings of the previously filed application, and the applicant did not include the claims of the previously filed application in the reference, then those sequences are not included in the European application as originally filed, even if the applicant subsequently filed a sequence listing complying with WIPO Standard ST.25 later on in the prosecution of that previously filed application (later filed sequence listings are not part of the description according to Rule 30(2)).

Where the previously filed application is not available to the EPO, it will not be possible to carry out the check according to Rule 57(j) on the compliance of the sequence listing with Rule 30(1) until the applicant files the certified copy and any translation required, which must be done within two months of the date of filing (Rule 40(3)). After the certified copy and translation, where applicable, are received, if it transpires that the sequence listing contained therein does not comply with Rule 30(1) in conjunction with the rules laid down by the President of the EPO, the European Patent Office will send a communication according to Rule 30(3) inviting the applicant to correct any deficiencies (including the lack of the electronic listing and/or, where applicable, the lack of a statement of identity of the electronic listing with the written listing) and pay the late furnishing fee (see A-IV, 5).

If the previous application referred to is a European application or an International application filed with the EPO as receiving Office, and this application satisfied the requirements of Rule 30 or Rule 5(2) PCT in combination with WIPO Standard ST.25 **on its date of filing** then all the requirements of Rule 30(1) are satisfied automatically on the date of filing of the European application filed by reference to this application.

In all other cases, however, the applicant will have to ensure that all the requirements of Rule 30(1), in conjunction with the rules laid down by the President of the EPO, are met. This means that if the previously filed application referred to is not one of the above types of application, even where it contains a written sequence listing conforming to WIPO Standard ST.25, the applicant will still have to provide an electronic form of the sequence listing complying with WIPO Standard ST.25 and, where applicable, a statement that the information in electronic form is identical to the written sequence listing, in order to satisfy the requirements of Rule 30(1) in conjunction with the rules laid down by the

President of the EPO. This includes the case where the previously filed application was a European application or International application filed with the EPO as receiving Office, but where one or more of the elements required to satisfy the requirements of Rule 30(1) or Rule 5(2) PCT in conjunction with WIPO Standard ST.25 were not present on the date of filing. If this is not the case, the procedure in A-IV, 5 will be followed (a communication under Rule 30(3) will be sent).

### **5.3 Sequence listings of a divisional application**

As an independent European patent application, a divisional application must also satisfy the requirements of Rule 30 in conjunction with the decision of the President of the EPO dated 28 April 2011 on the filing of sequence listings, OJ EPO 2011, 372 (see G 1/05, reasons 3.1). Without prejudice to the requirements of Art. 76(1), second sentence, if a sequence listing is to form part of the description of the divisional application, it must be submitted together with the other documents making up the divisional application, unless reference is made to a previously filed application containing a sequence listing as part of the application (Rule 40(1)(c)). However, an applicant who has filed a Standard-compliant sequence listing in TXT format under Rule 30 with regard to the earlier application (parent application) is exempted from having to submit said sequence listing for search purposes only (i.e. not as part of the description) in respect of the divisional application. The EPO will add a copy of the Standard-compliant sequence listing in TXT format filed in conjunction with the earlier application for search purposes only (i.e. not as part of the application) to the dossier on the divisional application (OJ EPO 2013, 542).

## **6. Conversion into a national application**

The central industrial property office of a Contracting State must apply the procedure for the grant of a national patent or another protective right provided for by the legislation of this State at the request of the applicant for or the proprietor of the European patent under the circumstances specified in Art. 135(1). If the request for conversion is not filed within the three-month period specified in Rule 155(1), the effect referred to in Art. 66 will lapse (i.e. the European application will cease to be equivalent to a regular national filing in the designated Contracting States).

*Art. 135*

The request for conversion is to be made to the EPO, except where the application is deemed withdrawn pursuant to Art. 77(3); in this case the request is filed with the central industrial property office with which the application was filed. That office shall, subject to the provisions of national security, transmit the request directly to the central industrial property offices of the Contracting States specified therein, together with a copy of the file relating to the European patent application. If the central industrial property office with which the application was filed does not transmit the request before the expiry of twenty months from the filing date, or if claimed, from the priority date, then Art. 135(4) applies (i.e. the effect of Art. 66 lapses).

*Art. 135(2)*

*Rule 155(2) and (3)*

*Art. 135(3)*  
*Rule 155(2)*

If a request for conversion is filed with the EPO, it must specify the Contracting States in which the application of national procedures is desired and be accompanied by a conversion fee. In the absence of the fee the applicant or proprietor is notified that the request will not be deemed to be filed until the fee is paid. The EPO transmits the request to the central industrial property offices of the specified Contracting States accompanied by a copy of the files relating to the European application or patent.

## Chapter V – Communicating the formalities report; amendment of application; correction of errors

### 1. Communicating the formalities report

After a formalities examination, the Receiving Section or, where appropriate, the Examining Division, issues a report to the applicant if the application is found to be formally defective. The report will usually identify all the particular requirements of the EPC which the application does not satisfy and, in the case of deficiencies which can be corrected, will invite the applicant to correct such deficiencies within specified periods (see A-III, 16). For the exceptional case where the report does not detail all deficiencies, see A-III, 16.1. The applicant will be notified of the consequences, e.g. application deemed withdrawn, priority right lost, which result from the deficiencies or failure to take appropriate action within due time.

In general, depending on the deficiency in question, either:

- (i) a time limit will be specified by the EPO, subject to Rule 132, for meeting the objection, e.g. an invitation to supply the priority document or priority file number under Rule 59, or
- (ii) a fixed time limit will apply, e.g. two months for correcting deficiencies under Rule 58.

For further details see E-VII, 1. If a deficiency is not rectified within due time, then the legal effects that are envisaged will apply.

### 2. Amendment of application

#### 2.1 Filing of amendments

Prior to the receipt of the European search report the applicant may amend his application only if the Receiving Section has invited him to remedy particular deficiencies, including the case where no claims are present in the application as originally filed, wherein the applicant must rectify this deficiency by filing a set of claims in response to a communication according to Rule 58 (see A-III, 15). After receipt of the European search report and before receipt of a first communication from the Examining Division, i.e. also during the period in which the application may still be with the Receiving Section, the applicant may of his own volition amend the description, claims and drawings (Rule 137(2)). Furthermore, where a search opinion accompanies the search report under Rule 62(1), the applicant must respond to it by filing observations and/or amendments (see B-XI, 8, for details and exceptions to this requirement). However, the European patent application may not be amended in such a way that it contains subject-matter which extends beyond the content of the application as

*Rule 58*  
*Rule 137(1) and (2)*  
*Art. 123(1) and (2)*  
*Rule 68(4)*

filed (regarding the publication of claims thus amended in response to the European search report under Rule 137(2), see also A-VI, 1.3).

## **2.2 Examination of amendments as to formalities**

*Rule 58*  
*Rule 137(1)*

The Receiving Section examines amendments, filed before the receipt of the search report, for formal requirements. Such amendments must remedy the deficiencies notified by the Receiving Section. The description, claims and drawings may be amended only to an extent sufficient to remedy the disclosed deficiencies and this requirement makes it necessary for the Receiving Section to compare any amended description, claims and drawings with those originally filed. Where, for example, a fresh description is filed to replace an earlier description that was objected to on account of non-compliance with the physical requirements, the Receiving Section must compare both descriptions and the objection is not met until there is identity of wording. However, identity of wording with the application documents as originally filed is not a requirement for amendments rectifying the following deficiencies:

- (i) filing at least one claim according to Rule 58, where no claims existed on filing (see A-III, 15) (these claims must still satisfy the requirements of Art. 123(2), but this check is carried out by the Search and Examining Divisions)
- (ii) the filing of missing parts of the description, or drawings according to Rule 56 (see A-II, 5).

Amendments which extend beyond the remedying of deficiencies and which are filed prior to receipt of the search report may be taken into consideration in the subsequent procedure provided that, on receipt of the search report, the applicant declares that he wishes them to be maintained.

Examination as to formalities of amendments filed after the receipt of the search report and before the application is transferred to the Examining Division is the responsibility of the Receiving Section.

The procedure for effecting amendments is dealt with in H-III, 2.

## **3. Correction of errors in documents filed with the EPO**

*Rule 139*

Linguistic errors, errors of transcription and mistakes in any document filed with the EPO may be corrected on request. Requests for such amendments may be made at any time, provided that proceedings are pending before the EPO (see J 42/92). However, if the error to be corrected concerns items which third parties might expect to be able to take at face value, so that their rights would be jeopardised by correction, the request for correction must be filed as soon as possible, and at least in time that it could be incorporated in the publication of the European patent application. With regard to correction of priority claims, specific provisions apply, with a view to protecting the interests of third parties, which allow the applicant to correct priority claims and

lay down a time limit for doing so (see Rule 52(3) and A-III, 6.5.2). This ensures that corrected priority information is available when the application is published. The applicant can only correct the priority claim later than this date, in particular after publication of the application, under certain limited circumstances, where it is apparent on the face of the published application that a mistake has been made. See J 2/92, J 3/91 and J 6/91 as well as J 11/92 and J 7/94. Each of these decisions indicated situations under EPC 1973 in which the correction of priority data too late for a warning to be published with the application could be allowed. These same situations apply *mutatis mutandis* under EPC 2000 to the acceptance of requests to correct priority claims after the end of the time limit according to Rule 52(3). Regarding correction of the date indicated for the previous filing, see also A-III, 6.6.

If the error is in the description, claims or drawings, the correction must be obvious in the sense that it is immediately evident that nothing else could have been intended than what is offered as the correction. Such a correction may be effected only within the limits of what a skilled person would derive directly and unambiguously, using common general knowledge, and seen objectively and relative to the date of filing, from the whole of the documents as filed (see G 3/89 and G 11/91; see also H-VI, 4.2.1). The documents to be considered in assessing whether or not the correction is allowable are those of the application as originally filed, including any late-filed missing parts of the description, or drawings filed according to Rule 56, regardless of whether this resulted in a change of the date of filing (see A-II, 5 *et seq.*). However, claims filed after the filing date in response to an invitation according to Rule 58 (see A-III, 15) cannot be used in assessing the allowability of the request.

*Rule 139, 2nd sentence*

It is in particular not allowable to replace the complete application documents (i.e. description, claims and drawings) by other documents which the applicant had intended to file with his request for grant (see G 2/95). The Examining Division decides on the request for correction. If a request for correction is pending before termination of the technical preparations for publication, a reference to the request is published on the front page.

In the case of electronic filing of European patent applications, the technical documents (description, claims, abstract and drawings) may be attached in their original format, provided this format is one listed in the Decision of the President of the EPO dated 12 July 2007, Special edition No. 3, OJ EPO 2007, A.5. Pursuant to this Decision, these technical documents may also be attached in a format other than those listed, provided that the applicant informs the EPO, when filing the application, where the EPO can reasonably acquire the corresponding software. If, on the date of filing, the documents making up the European patent application are available both in the format provided by the EPO Online Filing software and in another admissible format in accordance with the above-mentioned Notice, the documents in the

latter format can also be used in order to determine whether a request for correction of the description, claims, or drawings is allowable.

==



## Chapter VI – Publication of application; request for examination and transmission of the dossier to Examining Division

### 1. Publication of application

#### 1.1 Date of publication

The application is published as soon as possible after the expiry of a period of eighteen months from the date of filing or, where priority is claimed, from the earliest priority date. The application may, however, be published before that date if requested by the applicant and provided the filing and search fees have been validly paid. If the decision granting the patent becomes effective before expiry of the period referred to above, the application and the patent specification will both be published early.

*Art. 93(1)*

If the applicant abandons his priority date, then the publication is deferred provided that the notification of the abandonment is received by the EPO before the termination of the technical preparations for publication. These preparations are considered terminated at the end of the day five weeks before the end of the eighteenth month from the date of priority, if priority is claimed, or from the date of filing, if the priority is abandoned or if no priority is claimed (see the Decision of the President of the EPO dated 12 July 2007, Special edition No. 3, OJ EPO 2007, D.1). The applicant is informed when they are actually completed, and also of the publication number and intended publication date. Where the notification of abandonment of the priority is received after that time, publication, if it has not already taken place, takes place as if the priority date applied, although a notice as to the abandonment of the priority will appear in the European Patent Bulletin (see F-VI, 3.5). The same procedure is followed when the priority right is lost under Art. 90(5) (see A-III, 6.10).

#### 1.2 No publication; preventing publication

The application is not published if it has been finally refused or deemed withdrawn or withdrawn before the termination of the technical preparations for publication. These preparations are considered terminated at the end of the day five weeks before the end of the eighteenth month from the date of filing or priority (see the Notice from the EPO, OJ EPO 2006, 406). The application is, however, published if, upon termination of the technical preparations for publication, a request for a decision under Rule 112(2) has been received but no final decision has yet been taken (see OJ EPO 1990, 455).

*Rule 67(2)*

If after termination of the technical preparations the application is withdrawn to avoid publication, non-publication cannot be guaranteed. The EPO will however try (in accordance with the principles of J 5/81) to prevent publication on a case-by-case basis if the stage reached in the publication procedure permits this reasonably easily.

*Rule 15*

The application may be withdrawn by means of a signed declaration, which should be unqualified and unambiguous (see J 11/80). The applicant is bound by an effective declaration of withdrawal (see C-V, 11), but may make it subject to the proviso that the content of the application is not made known to the public. This takes into account the procedural peculiarity that the applicant who makes his declaration of withdrawal later than five weeks before the date of publication cannot know whether publication can still be prevented. However, neither the application nor the designation of a Contracting State may be withdrawn as from the time a third party proves that he has initiated proceedings concerning entitlement and up to the date on which the EPO resumes the proceedings for grant.

**1.3 Content of the publication***Rule 68(1), (3) and (4)**Rule 20**Rule 32(1)*

The publication must contain the description, the claims and any drawings as filed, including any late-filed missing parts of the description, or drawings filed according to Rule 56 (see A-II, 5), provided that these were not subsequently withdrawn (see A-II, 5.5), and specify, where possible, the person(s) designated as the inventor(s). If the claims were filed after the date of filing according to the procedures explained in A-III, 15, this will be indicated when the application is published (Rule 68(4)).

The publication also indicates as designated Contracting States all States party to the EPC on the date the application was filed, unless individual states have been withdrawn by the applicant before the termination of the technical preparations for publication. When a European application filed before 1 April 2009 is published, the States for which protection is actually sought may not yet be known, because the time limit under Rule 39(1) for paying the designation fees is still running. Those definitively designated – through actual payment of designation fees – are announced later in the Register of European Patents and the European Patent Bulletin (see Information from the EPO, OJ EPO 1997, 479). For European divisional applications, see A-IV, 1.3.4.

*Rule 68(2) and (4)**Rule 66**Rule 139*

The publication also contains any new or amended claims filed by the applicant under Rule 137(2), together with the European search report and the abstract determined by the Search Division if the latter are available before termination of the technical preparations for publication. Otherwise the abstract filed by the applicant is published. The search opinion is not published with the European search report (Rule 62(2)). It is however open to file inspection (see A-XI, 2.1). If a request for correction under Rule 139 of errors in the documents filed with the EPO is allowed, it must be incorporated in the publication. If upon termination of the technical preparations for publication a decision is still pending on a request for correction of items which third parties might expect to be able to take at face value, so that their rights would be jeopardised by correction, this must be mentioned on the front page of the publication (see the case law in A-V, 3), as must a request for correction of errors in the description, claims or drawings

(see A-V, 3). If the EPO has received a communication from the applicant under Rule 32(1), ("expert solution"), this too must be mentioned (see the Notice from the EPO dated 7 July 2010, OJ EPO 2010, 498). Further data may be included at the discretion of the President of the EPO.

With the exception of documents which must be translated, originals of documents filed are used for publication purposes where these documents meet the physical requirements referred to in A-VIII, 2, otherwise the amended or replacement documents meeting these requirements are used. Prohibited material may be omitted from the documents before publication, the place and number of words or drawings omitted being indicated (see A-III, 8.1 and 8.2). Documents incorporated in an electronic file are deemed to be originals (Rule 147(3)).

#### **1.4 Publication in electronic form only**

All European patent applications, European search reports and European patent specifications are now published in electronic form only, on a publication server (see the Decision of the President of the EPO dated 12 July 2007, Special edition No. 3, OJ EPO 2007, D.3 and OJ EPO 2005, 126). These documents are not published on paper.

#### **1.5 Separate publication of the European search report**

If not published with the application, the European search report is published separately (also electronically).

## **2. Request for examination and transmission of the dossier to the Examining Division**

### **2.1 Communication**

The Receiving Section communicates to the applicant the date on which the European Patent Bulletin mentioned the publication of the European search report and draws his attention to the provisions with regard to the request for examination as set out in Art. 94(1) and (2) and Rule 70(1). If the communication wrongly specifies a later date than the date of the mention of the publication, the later date is decisive as regards the time limit for filing the request for examination (see A-VI, 2.2) and also for responding to the search opinion (see B-XI, 8, and A-VI, 3) unless the error is apparent. In the communication, the applicant is also informed that the designation fee(s) must be paid within six months of the date on which the European Patent Bulletin mentioned the publication of the search report (see A-III, 11.2 and 11.3).

*Rule 69(1) and (2)*

Where the time limit under Rule 70(1) is that within which the applicant must reply to the ESOP (i.e. where Rule 70(2) does not apply), the invitation under Rule 70a(1) is sent in a single communication together with the communication according to Rule 69(1) (see C-II, 3.3).

*Rule 70a(1)*

## 2.2 Time limit for filing the request for examination

- Art. 94(1) and (2)*  
*Rule 70(1)*
- The request for examination may be filed by the applicant up to the end of six months after the date on which the European Patent Bulletin mentions the publication of the European search report. The request for examination is not deemed to have been filed until the examination fee has been paid. If the applicant does not file the request for examination, including the payment of the examination fee, within the above time limit, then the procedure explained in A-VI, 2.3 applies.
- Art. 78(1)(a)*  
*Rule 41(1)*
- The mandatory Request for Grant form (Form 1001), contains a written request for examination. The applicant has only one procedural act – payment in due time of the examination fee (Art. 94(1) and Rule 70(1)) – to worry about.
- Art. 11(a) RFees*
- On the other hand, there is nothing to stop him paying the examination fee at the same time as he files the application. If, after receipt of the European search report, he decides not to pursue the application further and does not react to the invitation pursuant to Rule 70(2), the application will be deemed withdrawn pursuant to Rule 70(3), and the examination fee will be refunded in its entirety (see A-VI, 2.5).
- Point 12 AAD*  
*Point 6.1(b) AAD*
- If the applicant has filed an automatic debit order, the examination fee will normally be debited at the end of the six-month period. For cases in which he wishes the application to be transmitted earlier to the Examining Division, see the AAD in Annex A.1 of Supplementary publication 4, OJ EPO 2014, 13.
- Rule 70(1)*
- The request for examination may not be withdrawn.
- Regarding Euro-PCT applications entering the European phase, see E-VIII, 2.1.3 and 2.5.2.
- ## 2.3 Legal remedy
- Art. 94(2)*  
*Rule 112(1)*
- If the request for examination is not validly filed before expiry of the period under Rule 70(1), the application is deemed to be withdrawn and the applicant is notified accordingly. In response to this communication concerning loss of rights, the applicant can request further processing in accordance with Art. 121 and Rule 135.
- Rule 70(2) and (3)*  
*Rule 112(1)*  
*Art. 121*
- If the applicant has validly filed a request for examination before the European search report has been transmitted to him, the Receiving Section invites him according to Rule 70(2) to indicate within six months from the date of the mention of the publication of the search report in the European Patent Bulletin whether he desires to proceed further with his application. If he fails to respond to this request in time, the application is deemed to be withdrawn and the applicant is notified accordingly. In this case, the applicant may also avail himself of the legal remedy under Art. 121 and Rule 135 (further processing of the application). Regarding reimbursement of the examination fee, see A-VI, 2.2 and A-X, 10.2.4. C-VI, 3, describes the procedure in respect of a categorical request for examination, as provided for in



Rule 10(4), where the applicant waives the right to the communication according to Rule 70(2).

Regarding Euro-PCT applications entering the regional phase, see E-VIII, 2.1.3 and 2.5.2.

#### **2.4 Transmission of the dossier to the Examining Division**

If the Receiving Section finds that the request for examination was filed in due time, or the desire to proceed further with the application was indicated in due time (Rule 70(2)), it transmits the application to the Examining Division. Otherwise, it notes the loss of rights which has occurred (see Rule 112(1)).

*Art. 16*  
*Art. 18(1)*  
*Rule 10*

The dossier as transmitted to the Examining Division contains the following, some of which are present in a paper dossier, while others are present in a corresponding computer dossier:

- (i) all documents filed in relation to the application, including priority documents, translations and any amendments;
- (ii) any certificate filed in relation to display at an exhibition (see A-IV, 3) and any information furnished under Rule 31 when the application relates to biological material (see A-IV, 4);
- (iii) the European search report, if applicable the search opinion, the content of the abstract as drawn up by the Search Division, and the internal search note, if any;
- (iv) copies of documents cited in the search report, and two copies of the publication document(s);
- (v) the applicant's response to the search opinion (see B-XI, 8) or to the WO-ISA, supplementary international search report or IPER prepared by the EPO (see E-VIII, 3.2 and 3.3.4); and
- (vi) all relevant correspondence. Copies of certain EPO communications to applicants or inventors – currently Forms 1048, 1081, 1082 and 1133 – are kept only in the corresponding computer dossier: their most important elements can at all times be printed out (as Form 1190) and placed in the paper dossier.

The Receiving Section will direct attention to any aspects of the application which require urgent attention by the Examining Division, e.g. any letters which have to be answered before the application is examined in its proper turn.

## 2.5 Refund of examination fee

*Art. 11 RFees*

The examination fee is refunded:

- (i) in full if the European patent application is withdrawn, refused or deemed to be withdrawn before the Examining Divisions have assumed responsibility; or
- (ii) at a rate of 75% if the European patent application is withdrawn, refused or deemed to be withdrawn after the Examining Divisions have assumed responsibility but before substantive examination has begun. This applies in particular where the applicant does not respond to the search opinion on time (leading to the application being deemed to be withdrawn under Rule 70a(3) - see B-XI, 8), but does file on time either the request for examination according to Rule 70(1) (see C-II, 1) or confirmation that he wishes to proceed with the application according to Rule 70(2) (see C-II, 1.1). An applicant unsure whether substantive examination has begun and wanting to withdraw the application only if he will receive the 75% refund may make withdrawal contingent upon the refund ("conditional" withdrawal). The date of the start of examination (C-IV, 7.1) is indicated in the public part of the dossier and is thus open to file inspection in the European Patent Register after publication of the patent application. Before publication, the EPO will provide the applicant with the relevant information upon request, or this information can be accessed electronically via the MyFiles service.

For more details see OJ EPO 2013, 153.

## 2.6 Reduction in examination fee

*Art. 14(4)*

*Rule 6*

*Art. 14(1) RFees*

Where applicants having their residence or principal place of business within the territory of a Contracting State having a language other than English, French or German as an official language, and nationals of that State who are resident abroad avail themselves of the options provided for under Art. 14(4), the examination fee is reduced under certain circumstances (Rule 6(3) to (7) in conjunction with Art. 14(1) RFees) (see A-X, 9.2.1 and 9.2.3).

## 3. Response to the search opinion

*Rule 70a*

The applicant is required to respond to the search opinion within the time limit under Rule 70(1) or, if a communication under Rule 70(2) is sent (see C-II, 1.1), within the time limit under Rule 70(2). If the applicant fails to respond to the search opinion on time, the application is deemed to be withdrawn (Rule 70a(3)). For more details see B-XI, 8.

## Chapter VII – Languages

### 1. Provisions concerning the language of the proceedings

#### 1.1 Admissible languages; time limit for filing the translation of the application

European patent applications can be filed in any language. However, if filed in a language other than an official language of the EPO (English, French or German), a translation into English, French or German must be filed within two months of the date of filing (Rule 6(1)). Such translation may be subsequently brought into conformity with the original text of the application (but see A-VII, 6.2). For the procedure where the translation is not filed in time, see A-III, 14.

*Art. 14(1) and (2)*  
*Rule 6(1)*  
*Art. 90(3)*

Where the description is filed by reference to a previously filed application (see A-II, 4.1.3.1) and the previously filed application used for the reference is not in an official language of the EPO, the applicant must also file a translation into one of those languages within two months of the date of filing. With regard to the procedure when the translation is not filed on time, see also A-III, 14.

*Rule 40(3)*

However, the use of a non-EPO language does not automatically qualify the application for a reduction in the filing fee. This is only available under certain circumstances (see A-X, 9.2.1 and 9.2.2).

#### 1.2 Language of the proceedings



The official language of the EPO (English, French or German) in which the application is filed, or into which it is subsequently translated, constitutes the "language of the proceedings". Amendments to a European patent application or European patent must be filed in the language of the proceedings. This language is also used by the EPO in written proceedings. (As regards documents which are not filed in the correct language, see A-VII, 4 below).

*Art. 14(3)*  
*Rule 3(2)*

#### 1.3 European divisional applications; Art. 61 applications

Any European divisional application must be filed in the language of the proceedings of the earlier application from which it is divided. Alternatively, if the earlier (parent) application was not in an official language of the European Patent Office, the divisional application may be filed in the language of the earlier application. In this case a translation into the language of the proceedings for the earlier application shall then be filed within two months of the filing of the divisional application (see A-III, 14). The same applies for the filing of a new European patent application under Art. 61(1)(b).

*Rule 36(2)*  
*Art. 61(2)*

### 2. Derogations from the language of the proceedings in written proceedings



In written proceedings before the EPO any party may use any official language of the EPO. However, in such proceedings the EPO uses the language of the proceedings in the sense of Art. 14(3). In written

*Rule 3(1)*

proceedings the organs of the EPO cannot use any official language other than the language of the proceedings (see G 4/08).

*Art. 14(3) and (4)*  
*Rule 6(2)*

Natural or legal persons having their residence or principal place of business within an EPC Contracting State having a language other than English, French or German as an official language, and nationals of that state resident abroad, may file documents which have to be filed within a time limit in an official language of that state (“admissible non-EPO language”). For example, an Italian or Swiss applicant may file a reply to a communication from the Examining Division issued under Art. 94(3) in the Italian language. A translation of this document, into an official language of the EPO must be filed (Rule 6(2)). The translation can be into any EPO official language, regardless of the language of the proceedings.

Normally, the period allowed for filing this translation is one month after filing of the document, but if the document is a notice of opposition or appeal, or a petition for review (Art. 112a), the period extends to the end of the opposition or appeal period or the period for the petition for review, if this period expires later.

### **3. Documents to be used as evidence**

*Rule 3(3)*

Documents which are to be used as evidence may be filed in any language. This applies during any proceedings before the EPO and applies especially to publications (for instance, an extract from a Russian periodical cited by an opponent to show lack of novelty or lack of inventive step). However, the department dealing with the case may require a translation in one of the languages of the EPO, at the choice of the person filing the document. If the document is filed by the applicant in pre-grant proceedings, the EPO should require a translation, unless the examiners are fully competent in the language concerned. In most cases, however, such documents will be filed in opposition proceedings and a translation should be required. The department concerned may require this translation to be filed within a time limit. This is to be fixed on a case-by-case basis. The period allowed should depend on the particular language concerned and on the length of the document to be translated, taking into account the provisions of Rule 132 (minimum of two months, maximum of four months, exceptionally six months). Failure to provide the translation within the specified time limit means that the EPO may disregard the document in question.



## 4. Documents filed in the wrong language

### 4.1 Documents making up a European patent application

As explained in A-VII, 1.1, all the documents making up a European application can be filed in any language (i.e. those listed in A-II, 4.1, plus the claims if present on the date of filing and any text of the drawings present on the date of filing). Consequently, it is not possible to file these documents in the wrong language.

*Art. 78(1)*

Divisional applications and applications according to Art. 61(1)(b), however, must be filed in the language of the proceedings of the earlier parent application from which they derive. They may also be filed in the same non-official language as the earlier application and then translated into the language of the proceedings thereof (see A-IV, 1.3.3).

### 4.2 Other documents

If any document other than those making up the application (e.g. a letter from the applicant in reply to an invitation under Art. 94(3)) is not filed in one of the prescribed languages or, where the applicant avails himself of Art. 14(4), the required translation is not filed in due time, it is deemed not to have been received. The person who has filed the document must be notified accordingly by the EPO. Accompanying documents relating to performance of a procedural act subject to a time limit (e.g. filing the designation of the inventor, the certified copy of the earlier application for which priority is claimed or that application's translation under Rule 53(3) into one of the official languages of the EPO) are dealt with as follows: if the European application number is given, the document goes into the dossier and the procedural act is recognised as having been performed, but any other contents are ignored. Regarding the signature of accompanying documents, see A-VIII, 3.1.

*Art. 14(4)*

*Rule 3(1) and (2)*

According to Art. 115, following the publication of the European patent application, any person may file observations in writing concerning the patentability of the invention in respect of which the application has been filed. These written observations must be filed in English, French or German. Otherwise, they are deemed not to have been received.

*Art. 115*

*Rule 114(1)*

Even though deemed not to have been received, the document not filed in the prescribed language will become part of the file and therefore accessible to the public according to Art. 128(4). Observations by third parties and notices of oppositions will be communicated to the applicant or the patent proprietor, respectively, even if they have not been filed in the prescribed language and are therefore deemed not to have been filed (see Art. 14(4) and Rule 3(1) regarding the notice of opposition or Art. 14(4) and Rule 114(1) regarding third party observations) (see D-IV, 1.2.1 (v) regarding the legal consequences where a notice of opposition or notice of intervention of the assumed infringer is filed in a non-prescribed language).

*Art. 128(4)*

*Art. 14(4)*

## 5. Translation of the priority document

This point is dealt with in A-III, 6.8, F-VI, 3.4, and D-VII, 2.

## 6. Authentic text

### 6.1 General remark

*Art. 70(1)*

The text of an application or patent in the language of the proceedings is the authentic text. It follows therefore that the translation of the claims of the patent specification required by Art. 14(6) is for information only.

### 6.2 Conformity of translation with the original text

*Rule 7*

*Art. 70(2)*

*Art. 14(2)*

Where the applicant has filed an application in a language other than an official language of the EPO in accordance with Art. 14(2), or the application was filed by reference to a previously filed application which was not in an official language of the EPO (see A-II, 4.1.3.1) and the question arises as to whether a particular amendment proposed by the applicant or proprietor extends the content of the application or patent beyond the content of the application as filed and thus offends against Art. 123(2), the EPO should normally assume, in the absence of proof to the contrary, that the original translation into English, French or German is in conformity with the text in the original language, which can be any language (e.g. Japanese). However, it is the original text which constitutes the basis for determining such a question. Similarly, it is the original text which determines the content of the application as filed for the purposes of Art. 54(3) (see G-IV, 5.1).

An erroneous translation from the original language of filing may be brought into conformity with the original text (e.g. with the originally filed Japanese-language PCT application) at any time during proceedings before the EPO, i.e. during pre-grant proceedings and also during opposition proceedings. But during opposition proceedings any amendment to bring the translation into conformity must not be allowed if it offends against Art. 123(3), that is if it is an amendment of the claims of the patent which extends the protection conferred.



## 7. Certificate of translation

*Rule 5*

The EPO has the power to require the filing of a certificate, certifying that a translation supplied corresponds to the original text, within a period to be determined by it. The exercise of this power should be determined on a case-by-case basis and ought to be used only when the official concerned has serious doubts as to the accuracy of the translation. The certificate could be called for either from the person who made the translation or from some other competent person. Failure to file the certificate in due time will lead to the document being deemed not to have been received unless the EPC provides otherwise. This partial loss of rights is subject to further processing under Art. 121 and Rule 135.

Certificates are not in principle required in respect of the translations of the claims into the other two official languages required under Rule 71(3). *Rule 71(3)*

**8. Derogations from the language of the proceedings in oral proceedings**

These derogations are dealt with in E-IV.

*Rule 4*



## Chapter VIII – Common provisions

### 1. Representation

#### 1.1 Representation by a professional representative

Subject to the next sentence, no person may be compelled to be represented by a professional representative in proceedings before the EPO; this holds for all parties to such proceedings, e.g. applicants, proprietors, opponents. A party (natural or legal person) who has neither his residence nor principal place of business in a Contracting State must be represented by a professional representative; the party must act through this professional representative in all proceedings (other than filing the application including all acts leading to the assignment of a date of filing). To "be represented" is to be interpreted as meaning due representation, including not only notice of the appointment of a professional representative but also, where applicable, the filing of authorisations of the appointed representative (see A-VIII, 1.5). Should an opponent who is party to the proceedings and does not have either a residence or his principal place of business within the territory of one of the Contracting States fail to meet the requirement set out under Art. 133(2) in the course of the opposition procedure (e.g. the representative withdraws from the opposition case or the appointed representative is deleted from the list of professional representatives), he is requested to appoint a new representative. Irrespective of whether he does so, he should nevertheless be informed of the date and location of any oral proceedings. However, it has to be drawn to his attention that if he appears only by himself he is not entitled to act before the Division.

*Art. 133(1) and (2)*  
*Art. 90(3)*  
*Rule 152*

#### 1.2 Representation by an employee

Parties having their residence or principal place of business in a Contracting State are not obliged to be represented by a professional representative in proceedings before the EPO. They may, irrespective of whether they are legal or natural persons, be represented by an employee, who need not be a professional representative but who must be authorised. However, where such parties wish to be represented professionally before the EPO, such representation may only be by a professional representative. The parties themselves may also act directly before the EPO, even if they are represented by an employee or a professional representative. When conflicting instructions are received from the party and his representative, each should be advised of the other's action.

*Art. 133(3)*  
*Art. 134(1)*  
*Rule 152*

#### 1.3 Common representative

Joint applicants, joint proprietors of patents and more than one person giving joint notice of opposition or intervention may act only through a common representative. If the request for the grant of a European patent, the notice of opposition or the request for intervention does not name a common representative, the party first named in the relevant document will be considered to be the common representative. This

*Art. 133(4)*  
*Rule 151(1)*

representative can thus be a legal person. However, if one of the parties is obliged to appoint a professional representative this representative will be considered to be the common representative, unless the first named party in the document has appointed a professional representative. If the European patent application is transferred to more than one person, and such persons have not appointed a common representative, the preceding provisions will apply. If such application is not possible, the EPO will require such persons to appoint a common representative within a period to be specified. If this request is not complied with, the EPO will appoint the common representative.

For Rule 151 to apply, each party or his duly authorised representative must have signed the document (request for grant, notice of opposition, etc.) giving rise to his participation (see also A-III, 4.2.2 and A-VIII, 3.2 and 3.4). Otherwise the party cannot take part in the proceedings, nor therefore be represented by a common representative.

#### **1.4 List of professional representatives; legal practitioners**

*Art. 134(1) and (8)*

Professional representation of natural or legal persons or companies equivalent to legal persons may only be undertaken by professional representatives whose names appear on a list maintained for this purpose by the EPO. However, professional representation may also be undertaken in the same way as by a professional representative by any legal practitioner qualified in one of the Contracting States and having his place of business within such State, to the extent that he is entitled, within the said State, to act as a professional representative in patent matters.

#### **1.5 Signed authorisation**

*Rule 152*

Representatives acting before the EPO must on request file a signed authorisation (see A-VIII, 3.2) within a period to be specified by the EPO. If the requirements of Art. 133(2) are not fulfilled, the same period will be specified for the communication of the appointment and, where applicable, for the filing of the authorisation. Professional representatives who identify themselves as such will be required to file a signed authorisation only in certain cases (see the Decision of the President of the EPO dated 12 July 2007, Special edition No. 3, OJ EPO 2007, L.1). However, a legal practitioner entitled to act as a professional representative in accordance with Art. 134(8) or an employee acting for an applicant in accordance with Art. 133(3), first sentence, but who is not a professional representative, must file a signed authorisation; in Euro-PCT proceedings, persons representing clients in these capacities are not required to file signed authorisations if they have already filed an authorisation expressly covering proceedings established by the EPC with the EPO as receiving Office.

The authorisation can also be filed by the applicant. This also applies where the applicant is obliged to be represented, as fulfilling the requirement to be represented is not itself a procedural step under Art. 133(2) to which the rule of obligatory representation applies.

An association of representatives can be authorised to represent a party before the EPO within the meaning of Art. 134(1) (Rule 152(11)). A party appointing several representatives can authorise them collectively as an association instead of having to authorise each of them singly, provided that the association in question is registered with the EPO (OJ EPO 2013, 535).

An authorisation remains in force until its termination is communicated to the EPO. Transfer of representation or termination of authorisation can, subject to certain conditions, be effected electronically by the representative using the MyFiles service (see Decision of the President of the EPO dated 26 April 2012, OJ EPO 2012, 352). The authorisation will not terminate upon the death of the person who gave it unless the authorisation provides to the contrary.

#### 1.6 General authorisation

An authorisation may cover more than one application or patent. Also, a general authorisation enabling a representative to act in respect of all the patent transactions of the party making the authorisation may be filed. A corresponding procedure applies to the withdrawal of an authorisation.

*Art. 133(2)  
Rule 152(2), (4), (7),  
(8) and (9)*

However, the filing of a general authorisation is distinct from the appointment of a representative for a specific case. The party granting a general authorisation is not bound to appoint one of the representatives listed therein. Nor does a general authorisation allow the EPO to assume, without any additional information, that a person listed therein should be appointed as a representative in a specific case (see J 17/98). Therefore, in a specific case, a party wishing to appoint the representative(s) listed in a general authorisation must notify the EPO accordingly by referring to the general authorisation number already registered.

#### 1.7 Invitation to file authorisation

Where the appointment of a legal practitioner entitled to act as professional representative in accordance with Art. 134(8), or an employee acting for an applicant in accordance with Art. 133(3), first sentence, but who is not a professional representative, is communicated to the EPO without an authorisation being filed, the representative is invited to file the authorisation within a period to be specified by the EPO. Where a party having neither residence nor principal place of business within a Contracting State has failed to fulfil the requirements of Art. 133(2) (see A-VIII, 1.1), the invitation will be sent directly to the party concerned. The same period will be specified for the communication of the appointment and, where applicable, for the filing of the authorisation. The period may be extended in

*Rule 152(2) and (6)  
Rule 132*



accordance with Rule 132 on request by the representative or party as the case may be (see E-VII, 1.6). If such authorisation is not filed in due time, any procedural steps taken by the representative other than the filing of a European patent application will, without prejudice to any other legal consequences provided for in the EPC, be deemed not to have been taken. The party is informed accordingly.

## 2. Form of documents

### 2.1 Documents making up the European patent application

The physical requirements which the documents making up the European patent application, i.e. request, description, claims, drawings and abstract, must satisfy are set out in Rule 49 and with regard to drawings in Rule 46. In particular, when amending the application documents, amendments must be typed. Any submissions containing handwritten amendments to application documents – unless they involve graphic symbols and characters and chemical and mathematical formulae – are a formal deficiency under Rules 49(8) and 50(1). The President of the EPO may lay down further special formal or technical requirements for the filing of documents, in particular with regard to the filing of documents by technical means (Rule 2(1)). Notes on the preparation of OCR-readable patent applications were published in OJ EPO 1993, 59. In relation to the drawings, the particular requirements are dealt with in A-IX. The latter Chapter should, however, also be consulted with regard to the other documents mentioned, as the comments therein on the provisions of Rule 49 are of general application. Here, attention need only be drawn to Rule 49(7) which states that "the lines of each sheet of the description and of the claims shall preferably be numbered in sets of five, the numbers appearing on the left side, to the right of the margin".

### 2.2 Replacement documents and translations

Replacement documents and translations in an official language of documents filed under the provisions of Art. 14(2) or Rule 40(3) are subject to the same requirements as the documents making up the application.

### 2.3 Other documents

Documents other than those referred to in the previous paragraphs should be typewritten or printed with a margin of about 2.5 cm on the left-hand side of each page.

### 2.4 Number of copies

Documents relating to more than one application or patent (e.g. a general authorisation), or having to be communicated to more than one party, only need to be filed in one copy. However, letters accompanying submitted documents (in particular Form 1038) must be filed in one copy for each file to which the document they accompany relates.

*Rule 49(1)*

*Rule 50(1)*

*Rule 50(2)*





For example, where two different applications share a common priority claim, the applicant only needs to file one copy of the priority document, but this must be accompanied by two different letters each relating to one or the other application (preferably two copies of Form 1038). Each letter (or Form 1038) must be duly signed and indicate one or the other of the two application numbers in respect of which the priority document is being filed (see also A-VIII, 3.1).

## 2.5 Filing of subsequent documents

After a European patent application has been filed, documents as referred to in Rule 50 may be filed online, by delivery by hand or by post or, with the exception of authorisations and priority documents, may be filed by fax at the EPO's filing offices (see A-II, 1.2). Such documents may not be filed on diskette, by e-mail, telegram, telex or similar means (see also the Notice dated 12 September 2000 concerning correspondence with the Office via e-mail, OJ EPO 2000, 458). However, where interviews and oral proceedings before an Examining Division are held as a video-conference, documents filed subsequently as referred to in Rule 50 during the video-conference may be filed by e-mail, with the exception of authorisations. The details and conditions of such filings are laid down in the Decision of the President of the EPO dated 20 April 2012, OJ EPO 2012, 348. If documents relating to European patent applications are filed by fax, written confirmation reproducing the contents of the documents filed by these means and complying with the requirements of the Implementing Regulations to the EPC must be supplied on invitation from the EPO within a period of two months. If the applicant fails to comply with this request in due time, the fax is deemed not to have been received (see the Decision of the President of the EPO dated 12 July 2007, Special edition No. 3, OJ EPO 2007, A.3).

*Rule 2(1)*

Written confirmation is required if the documents so communicated are of inferior quality.

If in a fax a party avails himself of Art. 14(4), the subsequent copy must be filed in the same language as the fax, in which case the copy is deemed to have been received on the date of filing of the fax. The period under Rule 6(2) for filing the translation under Art. 14(4) begins on the day following the date of filing of the fax.

*Art. 14(4)*  
*Rule 6(2)*

For the filing of subsequent documents in electronic form, either online or on electronic data carriers, see additionally A-II, 1.3, 2nd paragraph, and the Decision of the President of the EPO dated 26 February 2009, OJ EPO 2009, 182 (with particular reference to Art. 8(2) thereof), which sets out the requirement for confirmation of the authenticity of documents filed in appeal proceedings by means of an enhanced electronic signature.

### 3. Signature of documents

#### 3.1 Documents filed after filing the European patent application

*Rule 50(3)*  
*Art. 133*

All documents other than annexes filed after filing the European patent application must be signed by the person responsible. The principles of Art. 133 are that only the applicant or his representative may act in the European patent grant procedure. Documents filed after filing the European patent application may therefore be effectively signed only by these persons.

Documents such as the priority document or the translation thereof must be accompanied by a separate letter or at least bear a note on the document itself that it is addressed to the EPO, duly signed by a person authorised to act before the EPO. This also applies, for example, to the designation of inventor if this has been signed by an applicant with neither residence nor principal place of business in one of the Contracting States to the EPC. As regards the authorisation, see A-VIII, 1.5. The signature of the entitled person confirming performance of a written act of procedure helps to clarify the state of the proceedings. It shows whether the act of procedure has been validly performed, and also prevents circumvention of the provisions relating to representation. Form 1038 (Letter accompanying subsequently filed items) may also be used as a separate letter. A separate form must be used for each file (see the Notice from the EPO, OJ EPO 1991, 64). The same applies when, instead of using Form 1038, the applicant submits an accompanying letter with the document in question (see also A-VIII, 2.4). In the case of electronic filing, several documents for a file can be attached on a single Form 1038E.

Form 1037 can be used for the subsequent filing, all at the same time, of items that relate to several applications, but without signature. Form 1037 is only an acknowledgment. Its use is particularly recommended for subsequent filing of documents already bearing the required signature (such as replies to communications or debit orders).

*Rule 50(3)*

If the signature is omitted on a document not falling within the meaning of A-VIII, 3.2, the EPO must invite the party concerned to sign within a fixed time limit. This also applies if the document in question bears the signature of an unentitled person (e.g. the secretary of an authorised representative), a deficiency which for the purposes of the time limits under way is treated as equivalent to omission of the signature of an entitled person. If signed in due time, the document retains its original date of receipt; otherwise it is deemed not to have been received. Likewise, documents filed electronically must be signed by an entitled person, although they may be transmitted using a smart card issued to another person. See also A-VIII, 3.2 below.

#### 3.2 Documents forming part of the European patent application

In addition to the documents referred to in A-VIII, 3.1 above, certain documents forming part of the application must be signed. These

documents include the request for grant, the designation of the inventor and, where applicable, the authorisation of a representative. In the case of electronic filing of a European patent application, a facsimile image of the signer's handwritten signature, a text-string signature or an enhanced electronic signature may be used to sign the aforementioned documents (Art. 7 of the Decision of the President of the EPO dated 26 February 2009, OJ EPO 2009, 182, and also Art. 8(2) of that decision, which sets out the requirement for confirmation of the authenticity of documents filed in appeal proceedings by means of an enhanced electronic signature, see also A-VIII, 2.5).

With the exception of the authorisation of a representative, the documents may be signed by an appointed representative instead of the applicant.

### **3.3 Form of signature**

A rubber stamp impression of a party's name, whether a natural or legal person, must be accompanied by a personal signature. Initials or other abbreviated forms will not be accepted as a signature. Where the party concerned is a legal person, a document may in general be signed by any person who purports to sign on behalf of that legal person. The entitlement of a person signing on behalf of a legal person is not checked by the EPO, except where there is reason to believe that the person signing is not authorised and in that case evidence of authority to sign should be called for.

Where a document is filed by fax, the reproduction on the facsimile of the signature of the person filing the document will be considered sufficient. The name and position of that person must be clear from the signature (see Decision of the President of the EPO dated 12 July 2007, Special edition No. 3, OJ EPO 2007, A.3).

In the case of electronic filing of documents, the signature may take the form of a facsimile signature, a text-string signature or an enhanced electronic signature (see Art. 7 and, for appeal proceedings, also Art. 8(2) of the Decision of the President of the EPO dated 26 February 2009, OJ EPO 2009, 182).

### **3.4 Joint applicants**

If there is more than one applicant (see A-VIII, 1.3), each applicant or his representative must sign the request for grant and, where applicable, the appointment of the common representative. This also applies if one of the applicants is considered the common representative pursuant to Rule 151(1), first sentence. However, the common representative may sign the designation of inventor and all documents filed after the filing of the application pursuant to Rule 50(3). Authorisations on behalf of more than one applicant must be signed by all applicants.

*Rule 151(1)*



## Chapter IX – Drawings

This Chapter of the Guidelines deals with the requirements to be met by drawings contained in the application or patent. However, it should be noted that the comments on the provisions of Rule 49 apply generally to the documents making up the European patent application and documents replacing them.

*Rule 49*

*Rule 50*

### 1. Graphic forms of presentation considered as drawings

#### 1.1 Technical drawings

All types of technical drawings are considered drawings within the meaning of the EPC; these include, for instance, perspectives, exploded views, sections and cross-sections, details on a different scale, etc. Drawings also cover "flow sheets and diagrams", under which are subsumed functional diagrams and graphic representations of a given phenomenon which express the relationship between two or more magnitudes.

*Rule 46(3)*

There are also other graphic forms of presentation which may be included in the description, claims or abstract, in which case they are not subject to the same requirements as drawings. The forms concerned are chemical and mathematical formulae and tables. These are dealt with in A-IX, 11. They may nevertheless be submitted as drawings, in which case they are subject to the same requirements as drawings.

*Rule 49(9)*

#### 1.2 Photographs

The EPC makes no express provision for photographs; they are nevertheless allowed where it is impossible to present in a drawing what is to be shown and provided that they are directly reproducible and fulfil the applicable requirements for drawings (e.g. paper size, margins, etc.). Colour photographs are accepted, but will be scanned, printed and made available via file inspection only in black and white. If colours are necessary for discerning details of the photographs submitted, these details may be lost when the photograph is made available in black and white via publication and file inspection.

Photographs (or copies thereof) are to be numbered like drawings (Rule 46(2)(h)) and briefly described in the description (Rule 42(1)(d)).

### 2. Representation of drawings

#### 2.1 Grouping of drawings

All drawings must be grouped together on the sheets specifically for drawings and may in no event be included in the description, claims or abstract, even if these finish at the top of a page or leave sufficient room, and even if there is only one figure.

*Rule 49(9)*

## 2.2 Reproducibility of drawings

*Rule 49(2)*

In accordance with Rule 49(2) the drawings must be so presented as to admit of electronic as well as of direct reproduction by scanning, photography, electrostatic processes, photo offset and micro-filming, in an unlimited number of copies.

## 2.3 Figure accompanying the abstract

As regards the figure, or exceptionally figures, to accompany the abstract, where a European patent application contains drawings, reference should be made to A-III, 10.3 and F-II, 2.3 and 2.4. The figure(s) illustrating the abstract must be the figure(s) most representative of the invention and must be chosen from the drawings accompanying the application. It is therefore not permissible to draw a special figure for the abstract which differs from the other figures in the application.

## 3. Conditions regarding the paper used

*Rule 49(3)*

Drawings must be on sheets of A4 paper (29.7 cm x 21 cm) which must be pliable, strong, white, smooth, matt and durable (recommended paper weight: 80-120 g/m<sup>2</sup>, see OJ EPO 1994, 74).

*Rule 49(2)*

All sheets must be free from cracks, creases and folds. Only one side of the sheet may be used. The use of card is not allowed.

*Rule 49(12)*

Each sheet must be reasonably free from erasures and must be free from alterations. Non-compliance with this rule may be authorised if the authenticity of the content is not in question and the requirements for good reproduction are not in jeopardy.

Any corrections made must be durable and permanent, so that they cannot give rise to any doubt. Special products for corrections, such as white masking fluid, may be used, provided they are indelible and comply with the other requirements under Rule 49(12).

*Rule 49(4)*

The sheets must be connected in such a way that they can easily be turned over, separated and joined together again.

Permanent fastenings (for example, crimped eyelets) are not permitted. Only temporary fastenings (staples, paper clips and grips, etc.), which leave only slight marks in the margin, may be used.

## 4. Presentation of the sheets of drawings

### 4.1 Usable surface area of sheets

*Rule 46(1)*

On sheets containing drawings, the usable surface area may not exceed 26.2 cm x 17 cm. These sheets may not contain frames round the usable or used surface. The minimum margins are as follows: top side: 2.5 cm; left side: 2.5 cm; right side: 1.5 cm; bottom 1 cm.

## 4.2 Numbering of sheets of drawings

All the sheets contained in the European patent application must be numbered in consecutive Arabic numerals. These must be centred at the top of the sheet, but not in the top margin. *Rule 49(6)*

The sheets of drawings must be numbered within the maximum usable surface area as defined in Rule 46(1). Instead of numbering the sheet in the middle, it will, however, be acceptable for it to be numbered towards the right-hand side if the drawing comes too close to the middle of the edge of the usable surface. This numbering should be clear, for example in numbers larger than those used for reference numbers. *Rule 46(1)*

Rule 49(6) requires all application sheets to be numbered consecutively. According to Rule 49(4), the application consists of all the following documents: the request, the description, the claims, the drawings and the abstract. The numbering should preferably be effected by using three separate series of numbering each beginning with one, the first series applying to the request only and being already printed on the form to be used, the second series commencing with the first sheet of the description and continuing through the claims until the last sheet of the abstract, and the third series being applicable only to the sheets of the drawings and commencing with the first sheet of such drawings. *Rule 49(4)*

There are no objections to including the description, claims and drawings in one series of numbering beginning with one. The series of numbering must then commence with the first sheet of the description.

## 5. General layout of drawings

The various figures on the same sheet of drawings must be laid out according to certain requirements as to page-setting and numbering, and figures divided into several parts must comply with particular requirements.

### 5.1 Page-setting

As far as possible all figures of the drawings should be set out upright on the sheets. If a figure is broader than it is high, it may be set out so that the top and bottom of the figure lie along the sides of the sheet with the top of the figure on the left side of the sheet. *Rule 46(2)(h)*

In this case, if other figures are drawn on the same sheet, they should be set out in the same way, so that all the figures on a single sheet lie along parallel axes.

Where the sheet has to be turned in order to read the figures, the numbering should appear on the right-hand side of the sheet.

## 5.2 Numbering of figures

*Rule 46(2)(h)* The different figures must be numbered consecutively in Arabic numerals, independently of the numbering of the sheets.

*Rule 46(2)(d)* This numbering should be preceded by the abbreviation "FIG", whatever the official language of the application. Where a single figure is sufficient to illustrate the invention, it should not be numbered and the abbreviation "FIG" must not appear. Rule 46(2)(d) also applies to numbers and letters identifying the figures, i.e. they must be simple and clear and may not be used in association with brackets, circles, or inverted commas. They should also be larger than the numbers used for reference signs.

An exception to Rule 46(2)(h) referred to above may be permitted only as regards partial figures intended to form one whole figure, irrespective of whether they appear on one or several sheets. In this case the whole figure may be identified by the same number followed by a capital letter (e.g. FIG 7A, FIG 7B).

## 5.3 Whole figure

*Rule 46(2)(h)* Where figures drawn on two or more sheets are intended to form one whole figure, the figures on the several sheets shall be so arranged that the whole figure can be assembled without concealing any part of the partial figures.

Partial figures drawn on separate sheets must always be capable of being linked edge to edge, that is to say no figure may contain parts of another.

The case may arise where the parts of a whole figure are drawn on a single sheet following a layout different from that of the whole figure, e.g. a very long figure divided into several parts placed one above the other and not next to one another on a sheet. This practice is permitted. However, the relationship between the different figures must be clear and unambiguous. It is therefore recommended that a scaled-down figure be included showing the whole formed by the partial figures and indicating the positions of the sections shown.

## 6. Prohibited matter

*Rule 48(1) and (2)* The provisions as to the omission of prohibited matter within the meaning of Rule 48(1)(a) (see A-III, 8.1, and F-II, 7.2) also apply to drawings.

*Rule 48(1)(c)* Statements or other matter of the type referred to under Rule 48(1)(c) (see F-II, 7.4) which are likely to appear in drawings are in particular various kinds of advertising, e.g. where the applicant includes in the drawing obvious business or departmental markings or a reference to an industrial design or model, whether registered or not. By doing so, matter would be introduced which is clearly irrelevant or unnecessary, which is expressly prohibited by Rule 48.



## 7. Executing of drawings

### 7.1 Drawings of lines and strokes

Rule 46(2)(a) sets certain standards for lines and strokes in the drawing, to permit satisfactory reproduction by the various means described in Rule 49(2). *Rule 46(2)(a)*  
*Rule 49(2)*

The drawings must be executed in black.

In all cases the thickness of the lines and strokes must take into account the scale, nature, execution and perfect legibility of the drawing and of the reproductions.

All lines must be drawn with the aid of drafting instruments save those for which no instrument exists, e.g. irregular diagrams and structures. *Rule 46(2)(e)*

### 7.2 Shading

The use of shading in figures is allowed provided this assists in their understanding and is not so extensive as to impede legibility.

### 7.3 Cross-sections

#### 7.3.1 Sectional diagrams

Where the figure is a cross-section on another figure, the latter should indicate the position and may indicate the viewing direction.

Each sectional figure should be capable of being quickly identified, especially where several cross-sections are made on the same figure, e.g. by inscribing the words "Section on AB", or to avoid the use of lettering, by marking each end of the cross-section line on the diagram with a single Roman numeral. This number will be the same as the (Arabic) numeral identifying the figure where the section is illustrated. For example: "Figure 22 illustrates a section taken along the line XXII-XXII of Figure 21".

#### 7.3.2 Hatching

A cross-section must be set out and drawn in the same manner as a normal view whose parts in cross-section are hatched with regularly spaced strokes, the space between strokes being chosen on the basis of the total area to be hatched. *Rule 46(2)(b)*

Hatching should not impede the clear reading of the reference signs and leading lines. Consequently, if it is not possible to place references outside the hatched area, the hatching may be broken off wherever references are inserted. Certain types of hatching may be given a specific meaning.

### 7.4 Scale of drawings

If the scale of the figure is such that all the essential details would not be clearly distinguished if the figure is reproduced, electronically or photographically, with a linear reduction in size to two-thirds, then the *Rule 46(2)(c)*

figure must be redrawn to a larger scale, and if necessary the figure should be split up into partial figures so that a linear reduction in size to two-thirds is still intelligible.

The graphic representation of the scale of drawings in cases where its inclusion is considered useful must be such that it is still usable when the drawing is reproduced in reduced format. This excludes indications of size such as "actual size" or "scale 1/2", both on the drawings and in the description, in favour of graphic representations of the scale.

### **7.5 Numbers, letters and reference signs**

*Rule 46(2)(d)*

Numbers, letters and reference signs and any other data given on the sheets of drawings, such as the numbering of figures, pages of the drawing, acceptable text matter, graduations on scales, etc., must be simple and clear, and not used in association with any brackets, inverted commas, circles or outlines whatsoever. Signs such as 6' and 35" are not regarded as including inverted commas and are therefore permitted.

Numbers, letters and reference signs should preferably all be laid out the same way up as the diagram so as to avoid having to rotate the page.

#### **7.5.1 Leading lines**

Leading lines are lines between reference signs and the details referred to. Such lines may be straight or curved and should be as short as possible. They must originate in the immediate proximity of the reference sign and extend at least as far as the features indicated.

*Rule 46(2)(a)*

Leading lines must be executed in the same way as lines in the drawing, viz. in accordance with Rule 46(2)(a).

#### **7.5.2 Arrows**

Arrows may be used at the end of the leading lines provided that their meaning is clear. They may indicate a number of points:

- (i) a freestanding arrow indicates the entire section towards which it points;
- (ii) an arrow touching a line indicates the surface shown by the line looking along the direction of the arrow.

#### **7.5.3 Height of the numbers and letters in the drawings**

*Rule 46(2)(g)*

Under Rule 46(2)(g), a minimum size of 0.32 cm is required for all numbers and letters used on the drawings so that their reduction in size to two-thirds remains easily legible.

The Latin alphabet should normally be used for letters. The Greek alphabet is to be accepted however where it is customarily used, e.g. to indicate angles, wavelengths, etc.

#### **7.5.4 Consistent use of reference signs as between description, claims and drawings**

Reference signs not mentioned in the description and claims may not appear in the drawing, and vice versa. *Rule 46(2)(i)*

Reference signs appearing in the drawing must be given in the description and the claims taken as a whole. As regards use of these signs in the claims, reference should be made to F-IV, 4.19.

Features of a drawing should not be designated by a reference in cases where the feature itself has not been described. This situation may arise as a result of amendments to the description involving the deletion of pages or whole paragraphs. One solution would be to strike out on the drawing reference signs which have been deleted in the description. Such corrections would have to be made in accordance with Rule 49(12). *Rule 49(12)*

Where for any reason a figure is deleted then of course the applicant or proprietor ought to delete all reference signs relating solely to that figure appearing in the description and claims.

In the case of applications dealing with complex subjects and incorporating a large number of drawings, a reference key may be attached to the end of the description. This key may take whatever form is appropriate and contain all the reference signs together with the designation of the features which they indicate. This method could have the advantage of standardising the terminology used in the description.

#### **7.5.5 Consistent use of reference signs as between drawings**

The same features, when denoted by reference signs, must, throughout the application, be denoted by the same signs. *Rule 46(2)(i)*

There would be considerable confusion if a single feature were allocated different reference signs in the various drawings. However, where several variants of an invention are described, each with reference to a particular figure, and where each variant contains features whose function is the same or basically the same, the features may, if this is indicated in the description, be identified by reference numbers made up of the number of the figure to which it relates followed by the number of the feature, which is the same for all variants, so that a single number is formed, e.g. the common feature "15" would be indicated by "115" in Fig. 1 while the corresponding feature would be indicated by "215" in Fig. 2. This system has the advantage that an individual feature and the figure on which it is to be considered can be indicated at the same time. It can also make complex cases involving many pages of drawings easier to read. Instead of the common reference sign being prefixed by the number of a figure, it may, when the individual variants are described with reference to particular groups of figures, be prefixed by the number of

the particular variant to which it relates; this should be explained in the description.

### **7.6 Variations in proportions**

*Rule 46(2)(f)*

Elements of the same figure must be in proportion to each other, unless a difference in proportion is indispensable for the clarity of the figure.

As a preferred alternative to a difference in proportion within one figure for the purpose of achieving the necessary clarity, a supplementary figure may be added giving a larger-scale illustration of the element of the initial figure. In such cases it is recommended that the enlarged element shown in the second figure be surrounded by a finely drawn or "dot-dash" circle in the first figure pinpointing its location without obscuring the figure.

### **8. Text matter on drawings**

*Rule 46(2)(d) and (g)*

It should first be noted that Rule 46(2)(d) and (g) also applies to text matter on the drawings.

For indications of the type "section on AB", see A-IX, 7.3.1.

*Rule 46(2)(j)*

The drawings must not contain text matter, except, when absolutely indispensable, a single word or a few words.

Where text matter is deemed indispensable for understanding the drawing, a minimum of words should be used, and a space free of all lines of drawings should be left around them for the translation.

As regards the justification for text matter on drawings, see F-II, 5.1.

### **9. Conventional symbols**

*Rule 49(10)*

Known devices may be illustrated by symbols which have a universally recognised conventional meaning, provided no further detail is essential for understanding the subject-matter of the invention. Other signs and symbols may be used on condition that they are not likely to be confused with existing conventional symbols, that they are readily identifiable, i.e. simple, and providing that they are clearly explained in the text of the description.

Different types of hatching may also have different conventional meanings as regards the nature of a material seen in cross-section.

### **10. Amendments to drawings**

Amendments of the drawings are permitted, as well as of the other documents. These amendments may be made at the request of the party concerned or at the request of the EPO. The amendments may concern either clerical errors or more substantial changes.

Amendments to drawings are, in general, subject to the same rules as apply in respect of amendments to other application documents and therefore do not require further analysis here. Reference may be made to A-III, 16; A-V, 2; B-XI, 8; C-III, 2; C-IV, 5; Part H, in particular H-II, 2 and H-III, 2.

The general rule governing the admissibility of amendments, which the examiner must always bear in mind, is that they must not extend the content of the application as filed, i.e. they must not have the effect of introducing new material.

*Art. 123(2)*

If drawings which depart substantially from the physical requirements laid down in the Rules are filed in order to establish a particular date of filing or retain a priority date, the Receiving Section will permit such drawings to be amended or replaced so as to provide drawings complying with the Rules, provided that it is clear that no new material is thereby introduced into the application. In view of this proviso, applicants should take care that any "informal" drawings which they file clearly show all the features necessary to illustrate the invention.

## **11. Graphic forms of presentation not considered as drawings**

### **11.1 Chemical and mathematical formulae**



In exceptional cases, chemical or mathematical formulae may be written by hand or drawn if necessary, but it is recommended that appropriate aids such as stencils or transfers be used. For practical reasons, formulae may be grouped together on one or more sheets annexed to the description and paginated with it. It is recommended in such cases that each formula be designated by a reference sign and the description should contain references to these formulae whenever necessary.

*Rule 49(8)*

The chemical or mathematical formulae must employ symbols in general use and must be drawn in such a way that they are completely unambiguous. Figures, letters and signs which are not typed must be legible and identical in form in the various formulae, irrespective of the document in which they appear.

*Rule 49(11)*

Chemical or mathematical formulae appearing in the text of the application or patent must have symbols, the capital letters of which are at least 0.21 cm high. Where they appear on sheets of drawings, these symbols must be at least 0.32 cm high.

*Rule 49(8)*

*Rule 46(2)(g)*

All mathematical symbols used in a formula which appears in a description, in an annex or on sheets of drawings must be explained in the description, unless their significance is clear from the context. In any case, the mathematical symbols used may be collated in a list.

## **11.2 Tables**

### **11.2.1 Tables in the description**

*Rule 49(9)*

For the sake of convenience, the tables may also be grouped together in one or more sheets annexed to the description and paginated with it.

If two or more tables are necessary, each should be identified by a Roman number, independently of the pagination of the description or drawings or of the figure numbering, or by a capital letter, or by a title indicating its contents, or by some other means.

Each line or column in a table must begin with an entry explaining what it represents and, if necessary, the units used.

*Rule 49(5) and (8)*

It should be remembered that the characters must satisfy the requirements of Rule 49(8) and that Rule 49(5) regarding the maximum usable surface areas of sheets applies to tables as well.

### **11.2.2 Tables in the claims**

*Rule 49(9)*

The claims may include tables if this is desirable in view of the subject-matter involved. In this case, the tables must be included in the text of the relevant claim; they may not be annexed to the claims nor may reference be made to tables contained in or annexed to the description. Rule 43(6) stipulates that the claims may refer to other application documents only where this is absolutely necessary (see F-IV, 4.17). The mere desire to eliminate the need to prepare further copies does not constitute absolute necessity.

## Chapter X – Fees

### 1. General

Various fees have to be paid for a European patent application, renewing a European patent and obtaining legal remedies. Fees may also need to be paid by third parties, such as for applications to inspect the files of European patent applications or European patents. Fees may be validly paid by any person. The amounts of the fees, the ways in which they are to be paid and the date of payment are determined in the Rules relating to Fees (RFees). Guidance for the payment of fees, costs and prices with information about:

- the current version of the Rules relating to Fees and the schedule of fees;
- important implementing rules to the Rules relating to Fees;
- the payment and refund of fees and costs;
- other notices concerning fees and prices; and
- international applications, including Euro-PCT applications entering the European phase,

as well as the amounts of the principal fees for European and international applications and an extract from the Rules relating to Fees is published at regular intervals in the Official Journal. A list of bank accounts opened in the name of the European Patent Organisation for payment appears each month on the inside back cover. Information relating to fees can also be found on the EPO website ([www.epo.org](http://www.epo.org)) under: Applying for a patent/Forms and fees/Making payments.

The EPC and the Implementing Regulations thereto lay down the time limits for paying fees and the legal consequences of non-compliance with the time limits. The time limits for payment and the legal consequences of non-payment are dealt with in the Chapters of the Guidelines covering the respective stages of the procedure. The methods of payment, the date on which payment is considered to be made, due dates, particulars concerning the purpose of payments and reimbursement of fees are all dealt with below.

### 2. Methods of payment

Fees may be paid in the following ways:

- (i) by payment or transfer to a bank account held by the EPO;
- (ii) by debiting a deposit account opened in the records of the EPO in Munich (see A-X, 4.2 and 4.3);

*Art. 5 RFees  
Point 6.2 ADA*

- (iii) by requesting re-allocation of a refund (see A-X, 10.5).

Debiting of deposit accounts in principle occurs on the basis of a debit order signed by the account holder. A debit order may be filed by means of EPO Online Filing or by means of Online Fee Payment. It may also be filed on paper or by fax, in which case the use of EPO Form 1010 or PCT Form PCT/RO/101 or IPEA/401 is mandatory. This applies to both individual and collective debit orders (lists), and also to orders filed by letter and not readable electronically. Failure to use the above forms will delay processing considerably, although payers will keep the original submission date as payment date. In such cases, however, for processing purposes, from 1 April 2014 onwards debit orders are to be resubmitted using the standard forms (see Supplementary publication 4, OJ EPO 2014, 3).

Payment by cheque delivered or sent directly to the EPO was abolished with effect from 1 April 2008 (see OJ EPO 2007, 533 and OJ EPO 2007, 626).

### 3. Currencies

The fees due to the EPO shall be paid in euro. A debit order shall be in euro.

*Art. 5 RFees  
Point 3 ADA*

### 4. Date considered as date on which payment is made

#### 4.1 Payment or transfer to a bank account held by the European Patent Organisation

The date on which the amount is actually entered in the European Patent Organisation's bank account is considered as the date on which payment is made. It is therefore also possible for the day following the payment or transfer to be considered as the date on which payment is made or an even later date in the event of delays within the bank. However, payment may still be considered to have been made in due time, despite being paid late, if the payment or transfer has been effected before expiry of the time limit for payment in a Contracting State and, where appropriate, a surcharge has been paid (see A-X, 6).

*Art. 7(1), (3) and  
(4) RFees*

#### 4.2 Deposit accounts with the EPO

##### 4.2.1 General remarks

The Arrangements for deposit accounts (hereinafter abbreviated to "ADA") and their annexes were published as Supplementary publication 4, OJ EPO 2014. A distinction must be drawn, in connection with deposit accounts, between:

*Art. 7(2) RFees*

*Point 4 ADA*

- (i) payments to replenish deposit accounts; and

*Point 6 ADA*

- (ii) payments of fees or of expenses for publications or services of the EPO by debiting the deposit account.



#### 4.2.2 Payments to replenish a deposit account

Payments to replenish a deposit account are to be made in euro. Payments in a different currency will only be accepted if freely convertible. Payments must be made to an EPO bank account. However, the deposit account will always be credited in euro (the only currency in which these accounts are kept) after conversion at the current rate of exchange.

*Points 3 and 4 ADA*

Repayments of deposit account balances can only be remitted to the deposit account holder. For this purpose, the deposit account holder must submit to the EPO a signed request containing all bank details necessary for the transfer.

*Point 4.3 ADA*

#### 4.2.3 Debiting the deposit account

The debit order must be clear, unambiguous and unconditional. It must contain particulars necessary to identify the purpose of the payment, including the amount of each fee or expense concerned, and must indicate the number of the account which is to be debited. The Boards of Appeal have decided that a debit order must be carried out notwithstanding incorrect information given in it if the intention of the person giving the order is clear (see T 152/82). Debiting occurs in principle on the basis of a written debit order signed by the account holder. The various ways in which a debit order may be filed, including online and fax filing, are given in point 6.2 ADA. No paper confirmation of a debit order should be sent.

*Points 6.2 and 6.3 ADA*

For payment orders submitted by means of EPO Online Filing or Online Fee Payment, the deposit account holder may however specify that a payment order is to be executed at a later date than the submission date. In that case, the payment date is deemed to be the execution date specified. Payment orders may be executed up to 40 days after the submission date.

#### 4.2.4 Date of receipt of the debit order; insufficient funds

Provided that there are sufficient funds in the deposit account on the date of receipt of the debit order by the EPO or on the date specified under point 6.3, second paragraph, ADA, that date will be considered as the date on which the payment is made. This is also applicable where a debit order is filed together with an application under point 6.6 or point 6.9 ADA with a competent national authority of a Contracting State. If the debit order is not received at the EPO until after expiry of the period allowed for payment of fees which can be paid on filing, that period is deemed to have been observed if evidence is available or presented to the EPO to show that the debit order was filed with the competent authority of the Contracting State at the same time as the application, provided that sufficient funds were available in the account at the time the period expired.

*Points 6.3, 6.6, 6.7 and 6.9 ADA*

If, on the date of receipt of the debit order or on the date specified under point 6.3, second paragraph, ADA, the account does not contain sufficient funds to cover the total fee payments indicated for an

*Point 6.4 ADA*

application (shortfall), the debit order is not carried out and the holder is informed accordingly by post, fax or e-mail. The payment is considered to have been made on the date on which the deposit account is duly replenished.

*Point 8 ADA*

### **4.3 Automatic debiting procedure**

A deposit account may also be debited on the basis of an automatic debit order signed by or on behalf of the account holder (automatic debiting procedure). Such an order may only be filed on behalf of the applicant or the patent proprietor or his representative and extends to all types of fees covered by the automatic debiting procedure and payable by him in respect of the proceedings specified in the automatic debit order. As the proceedings progress, each such fee is automatically debited and treated as having been paid in due time provided that the deposit account contains sufficient funds. The automatic debit order may not be restricted to specific types of fees. The Arrangements for the automatic debiting procedure (abbreviated to "AAD") plus explanatory notes are published as Annexes A.1 and A.2 to the ADA in Supplementary publication 4, OJ EPO 2014, 13 and 26. The AAD can also be found on the EPO website ([www.epo.org](http://www.epo.org)) under: Applying for a patent/Forms and fees/Making payments.

## **5. Due date for fees**

### **5.1 General**

#### **5.1.1 Due date**

*Art. 4(1) RFees  
Rule 51(1), 2nd  
sentence*

In the EPC, the term "due date" has a special meaning, namely the first day on which payment of a fee may be validly effected, not the last day of a period for such payment (see A-X, 6 "Payment in due time"). The due date for fees is generally laid down by provisions of the EPC or of the PCT. If no due date is specified, the fee is due on the date of receipt of the request for the service incurring the fee concerned. A fee may not be validly paid before the due date. The only exceptions to that principle are:

- (i) renewal fees, which may be validly paid up to three months before the due date (see A-X, 5.2.4), and
- (ii) voluntary payment of fees in response to the communication under Rule 71(3) (where amendments are also filed in response to that communication, see C-V, 4.2).

Payments made before the due date which are not valid may be refunded by the EPO. If payment is made shortly before the due date, it is possible that the EPO will not return the payment. In this case, however, payment only takes effect on the due date. See A-X, 5.2.4 regarding renewal fees for a European patent application.

### 5.1.2 Amount of the fee

When the fees are generally increased, the date of payment is set as the relevant date for determining the amount of the fees (see Art. 2 of the Decision of the Administrative Council dated 5 June 1992, OJ EPO 1992, 344). Setting the date of payment as the relevant date makes it unnecessary as a rule to ascertain the actual due date for determining the amount of the fee. Fees cannot validly be paid before the due date (with the exception of renewal fees – see A-X, 5.1.1). Thus, for example, the fee for grant and publishing cannot be validly paid in advance before notification of the communication under Rule 71(3).

## 5.2 Due date for specific fees

### 5.2.1 Filing fee and search fee

The filing and search fees are due on the day the European patent application is filed. They must be paid either within one month from that date (Rule 38) or, for Euro-PCT applications, within 31 months of the filing date or, where applicable, from the earliest priority claimed (see A-III, 13.1). For the additional fees payable as part of the filing fee, see A-III, 13.2 and A-IV, 1.4.1.1.

### 5.2.2 Examination fee and designation fee

The examination fee is due when the request for examination is filed. Since the latter is contained in the prescribed form for the request for grant (Form 1001), the examination fee may be paid straight away on the date of filing of the European patent application if the application is filed with said prescribed Form 1001. It may be paid up to expiry of the period laid down in Rule 70(1), namely within six months of the date of publication of the mention of the European search report.

The designation fee falls due upon publication of the mention of the European search report. It may be paid within six months of the mentioned date of publication (Rule 39).

For Euro-PCT applications, see E-VIII, 2.1.3.

### 5.2.3 Fee for grant and publishing

The fee for grant and publishing falls due on notification of the communication under Rule 71(3) requesting that this fee be paid. Under Rule 71(4), the same applies for claims fees, unless they were already paid under Rule 45(1) and (2) or Rule 162(1) and (2).

### 5.2.4 Renewal fees

Renewal fees for a European patent application in respect of the coming year are due on the last day of the month containing the anniversary of the date of filing of the European patent application. Renewal fees may not be validly paid more than three months before they fall due. When a renewal fee is due on the last day of the month according to Rule 51(1), the start of the three-month period for early payment is illustrated by the following examples: If a European

*Rule 51(1) and (2)*

application has a filing date in November 2008, according to Rule 51(1) the renewal fee for the third year has a due date of 30 November 2010 and the earliest date for payment is 31 August 2010; if a European application has a filing date in May 2009, according to Rule 51(1) the renewal fee for the third year has a due date of 31 May 2011 and the earliest date for payment is 28 February 2011. Renewal fee payments which are not valid will be refunded by the EPO. If payment is made only shortly before the permissible prepayment period, the EPO may elect not to return the payment. In this case, however, payment only takes effect on the first day of the permissible prepayment period.

If the renewal fee has not been paid on or before the due date, it may be validly paid within six months of the said date, provided that the additional fee is paid within this period. For the calculation of the additional period, see J 4/91. Whilst a notice draws the applicant's attention to the possibility under Rule 51(2) and Article 2(1), No. 5, RFees, he may not invoke the omission of such notification (see J 12/84 and J 1/89). For renewal fees for European divisional applications see A-IV, 1.4.3.

For Euro-PCT applications, if the renewal fee in respect of the third year would have fallen due earlier under Rule 51(1), it does not fall due until expiry of the 31st month, i.e. on the last day of the 31-month period under Rule 159(1). This deferred due date, and hence the expiry of another period (the 31-month period), forms the basis for calculating the additional period for payment of the renewal fee with an additional fee (see J 1/89, the principles of which apply). For example:

12.05.2008 (Mon)	Priority date
12.11.2008 (Wed)	Filing date
30.11.2010 (Tues)	Due date for third-year renewal fee under Rule 51(1)
12.12.2010 (Sun)	EPO closed
13.12.2010 (Mon)	Expiry of 31-month period under Rule 159(1) (extended under Rule 134(1))
13.06.2011 (Mon)	Last day for payment of the renewal fee (plus additional fee) since the six-month period under Rule 51(2) expires that day

If the applicant requests entry into the regional phase before the expiry of the 31-months period (cf Art. 22 and 39 PCT), in order for the request to become effective the renewal fee in respect of the third year has to be paid if the fee has fallen due earlier under Rule 51(1). If the renewal fee is not paid on the date early processing is requested, the request for early processing will be effective only as from the date on which the renewal fee is paid (and all further requirements necessary on the latter date have been complied with).

The obligation to pay renewal fees terminates with the payment of the renewal fee due in respect of the year in which the mention of the grant of the European patent is published, see Art. 86(2). For example:

15.12.2009 (Tue)	Priority date
02.08.2010 (Mon)	Filing date
31.08.2012 (Fri)	Due date for third-year renewal fee under Rule 51(1)
03.05.2012 (Thu)	First day for validly paying third-year renewal fee
28.02.2013 (Thu)	Last day for validly paying renewal fee (plus additional fee); see J 4/91 reasons 2.7
06.11.2013 (Wed)	Mention of grant of the European patent in the European Patent Bulletin
31.08.2013 (Sat)	Due date for the last renewal fee (fourth year) to be paid
02.09.2013	Last day for payment of last renewal fee without additional fee

Special provisions apply with regard to the due date for renewal fees in respect of cases where there is a successful request for re-establishment of rights under Art. 122 or a successful petition for review of a decision of the Board of Appeal under Art. 112a.

*Rule 51(4) and (5)*

### 5.2.5 Claims fees

Claims fees are due upon the filing of the first set of claims, which may be the date of filing or which may occur later (see A-III, 9 and 15).

### 5.2.6 Fees for limitation/revocation, opposition, appeal, petition for review

All of these fees are due on the date that the document in question is filed (request for limitation, request for revocation, notice of opposition, notice of appeal and petition for review).

## 6. Payment in due time

### 6.1 Basic principle

A fee is considered to have been paid in due time if the date of payment (see A-X, 4) fell on or before the last day of the relevant time limit – or the time limit extended pursuant to Rule 134.

### 6.2 Ten-day fail-safe arrangement

#### 6.2.1 Requirements

If the payer provides evidence to the EPO that within the period in which the payment should have been made in an EPC Contracting State:

*Art. 7(3) and (4) RFees*

- (i) he effected payment through a banking establishment; or
- (ii) he duly gave an order to a banking establishment to transfer the amount of the payment; or

*Point 6.5 ADA* (iii) he despatched at a post office a letter bearing the address of one of the filing offices (see A-II, 1.1) of the EPO containing the debit order, provided that there is a sufficient amount in the account on the date on which the time limit expires, ≡

**then** he is considered to have observed the period for payment, even if the payment is entered in the bank account of the European Patent Organisation after the expiry of the period or if a debit order despatched to the EPO is received there after the expiry of the period.

*Art. 7(3)(b) and (4) RFees  
Point 6.5(b) ADA* However, if, in such a case, the payment has been effected later than 10 days before expiry of the period for payment, but still within that period, a surcharge of 10% on the relevant fee or fees, but not exceeding EUR 150, must be paid in order for the period for payment to be considered observed. ≡

### **6.2.2 Application of the ten-day fail-safe arrangement to replenishment of deposit account**

*Point 5.2 ADA* The ten-day fail-safe arrangement under Art. 7(3), (a) and (b), second half sentence RFees applies *mutatis mutandis* to payments to replenish deposit accounts. If one of the steps referred to under A-X, 6.2.1(i) and 6.2.1(ii) is carried out in order to replenish a deposit account, then for the purpose of complying with time limits for payment by issuing debit orders, the account is considered to have been replenished on the tenth day after one of those steps was taken. ≡

### **6.2.3 Debit orders**

*Points 6.6, 6.7 and 6.9 ADA* For debit orders accompanying applications filed with a competent national authority, see A-X, 4.2.4. ≡

### **6.2.4 Payment of fee at the normal fee rate**

Where a fee can either be paid within a normal period at the normal fee rate or within the period for further processing with the requisite further processing fee, if the normal period for payment is considered to have been observed when applying the ten-day fail-safe arrangement, the above-mentioned further processing fee need not be paid.

### **6.2.5 Amount of fee payable**

As noted in A-X, 5.1.2, the amount of fee payable is always that applying on the date of payment (see also the transitional provisions in the Administrative Council decisions revising fees). The payer cannot therefore in this respect seek to rely on the ten-day fail-safe arrangement in order to benefit from an old amount, arguing that he gave instructions for payment before the entry into force of the new amount of fee (see J 18/85); Art. 7(3) and (4) RFees protects the applicant in the event of late payment from the legal consequences of expiry of the payment period, but not from the obligation to make up any differences resulting from an increase in the amount of fee in the meantime.

### **6.2.6 Noting of loss of rights**

If an applicant who has been sent a communication under Rule 112(1) noting non-compliance with a time limit for payment claims that the payment was made in due time pursuant to Art. 7(1), (3) and (4) RFees and points 5.2, 6.5, 6.8 or 6.10 of the Arrangements for deposit accounts, he must apply for a decision pursuant to Rule 112(2) and submit the requisite evidence.

*Rule 112*

## **7. Purpose of payment**

### **7.1 General**

#### **7.1.1 Condition for valid payment**

An essential condition for a valid payment to the EPO in the case of payment or transfer to a bank account held by the European Patent Organisation is that the amount is entered in that account. The payment is valid in respect of the amount entered. If an insufficient amount has been paid by mistake, it is not possible to rectify the error by having the shortfall paid subsequently deemed to be paid on the original date of payment. Payment is a matter of fact whereby a certain amount is transferred to and put at the disposal of the EPO. It is not, therefore, a procedural declaration which may be corrected pursuant to Rule 139. The same applies to debit orders (see T 170/83, reasons 8). Therefore, time limits for payment are in principle deemed to have been observed only if the full amount of the fee has been paid in due time. However, the EPO may, where this is considered justified, overlook any small amounts lacking without prejudice to the rights of the person making the payment (Art. 8 RFees).

#### **7.1.2 Purpose of payment**

A distinction must be drawn between these conditions for valid payment and the indication of the purpose of the payment. Indication of the purpose of the payment serves to identify the proceedings for which the fee is intended (e.g. for fee payments, the application number) and the specific type of fee. If the purpose of the payments cannot immediately be established, the person making the payment will be requested to communicate the purpose in writing within a specified period. If he complies with this request in due time, the payment and the original payment date remain valid. This is also the case when the clarification involves re-assigning the payment to another application. Otherwise the payment will be considered not to have been made. The Boards of Appeal have decided that if the purpose of the payment has evidently been given incorrectly, this deficiency is not prejudicial if the intended purpose can be established without difficulty from the remaining information. The inadvertent use of a fee by the EPO for a different purpose from that evidently intended by the person making the payment has no effect on the purpose intended by that person (see J 16/84). Similarly, a debit order must be carried out notwithstanding incorrect information given in it if the intention of the person giving the order is clear. Instructions to carry out the order

*Art. 6 RFees*

must be given by the EPO department qualified to recognise what is clearly intended (see T 152/82).

In the case of changes to the purpose of payment not arising from Art. 6(2) RFees, the date of payment is the date of receipt of the request for the change.

## **7.2 Indication of the purpose of the payment in the case of designation fees**

*Art. 2(2), No. 3 RFees*  
*Art. 6(1) RFees*

The following applies only to applications filed before 1 April 2009.

The designation fees are deemed paid for all Contracting States upon payment of seven times the amount of one designation fee. Such payments simply need to be marked "designation fees" in order for the purpose of the payment to be established. If fewer than seven designation fees are paid and the payment agrees with the declaration in the appropriate section of the Request for Grant form (Form 1001), payment should once again simply be marked "designation fees". However, if the payment differs from the intended payment as stated in the request form, the Contracting States for which the payment is now intended should be indicated with the payment.

If there is no such indication and the amount paid is insufficient to cover all the Contracting States mentioned in the appropriate section of the request form, the procedure under A-III, 11.3.7 applies.

If an automatic debit order has been issued (see the appropriate sections of Form 1001), the applicant must inform the EPO prior to expiry of the basic period under Rule 39(1) if he wishes to pay designation fees for Contracting States other than those indicated in the request form. If not, an amount equal to seven times the amount of one designation fee or the designation fees for the Contracting States indicated in the request form is debited.

The same applies where Form 1200 is used for entry into the European phase of a Euro-PCT application, if the application enters the regional phase before 1 April 2009.

## **7.3 Indication of the purpose of payment in the case of claims fees**

### **7.3.1 Claims fees payable on filing the European patent application**

*Rule 45(1)*

If the applicant pays the claims fees for all the claims incurring fees, the indication "claims fees" suffices to identify the purpose of the payment. If the amount paid is insufficient to cover all the claims fees, the procedure under A-III, 9 applies.



### 7.3.2 Claims fees payable before the grant of the European patent

In the communication under Rule 71(3), the applicant may be requested to pay claims fees due before grant of the European patent. *Rule 71(4)*  
If the applicant fails to pay the fee for all the claims in due time, the application is deemed to be withdrawn (Rule 71(7)).

### 8. No deferred payment of fees, no legal aid, no discretion

The EPC makes no provision for deferring payment of fees (see J 2/78, reasons 3) or for granting legal aid. An indigent party still has the possibility of applying for legal aid from the competent national authority. However, the time limit for payment is not extended in such a case; a party claiming national legal aid must make the corresponding arrangements as early as possible so that he is in a position to pay the fee in due time. The EPO has also no discretion in waiving or refunding, without any legal basis, fees that have become due (see J 20/87).

## 9. Reduction of fees

### 9.1 General

Where a fee is reduced – in contrast to cases of fee refunds – the reduced rate may be paid instead of the full fee. The factual conditions for a reduction of the fee must be met on or before the day the period for payment expires.

### 9.2 Reduction under the language arrangements

#### 9.2.1 Conditions

European applications can be filed in any language. If filed in a language other than an official language of the EPO, a translation must be furnished. Consequently, the languages which can be used for filing European applications fall into three categories: *Art. 14(2)*

- (i) official languages of the EPO
- (ii) official languages of Contracting States which are not official languages of the EPO, such as Dutch, Italian or Spanish (hereinafter "admissible non-EPO languages"), and
- (iii) all other languages, such as Chinese, Japanese or Russian.

Furthermore, documents which have to be filed within a time limit may also be filed in an "admissible non-EPO language" if the applicant has his residence or principal place of business within the territory of a Contracting State having this as an official language or if the applicant is a national of such a Contracting State. See A-VII, 1.1 and 1.2. *Art. 14(4)*

In the case of European patent applications filed on or after 1 April 2014, and of international applications entering the European phase on or after that date, a 30% reduction of the filing- and/or *Rule 6(3)*  
*Art. 14(1) RFees*

examination fee for certain categories of applicants is provided for (see the Notice from the EPO dated 10 January 2014, OJ EPO 2014, A23). In this regard, it is necessary to file the documents making up the application “as filed” and the request for examination in an admissible non-EPO language and to file the translation not earlier than simultaneously (see G 6/91).

*Rule 6(4)*

The categories of applicants eligible for the fee reductions are:

- small and medium-sized enterprises (SMEs),
- natural persons,
- non-profit organisations, universities and public research organisations,

whose residence or principal place of business is in an EPC contracting state with an official language other than English, French or German, and nationals of such states who are resident abroad.

*Rule 6(5)*

The definition of SMEs is that contained in European Commission Recommendation 2003/361/EC of 6 May 2003 as published in the Official Journal of the European Union. Under the recommendation, an enterprise is considered to be any entity engaged in an economic activity, irrespective of its legal form. The category of micro, small and medium-sized enterprises is made up of enterprises which employ fewer than 250 persons, which have an annual turnover not exceeding EUR 50 million and/or an annual balance sheet total not exceeding EUR 43 million and for which no more than 25% of the capital is held directly or indirectly by another company that is not an SME.

The eligibility of the further entities listed in Rule 6(4) is subject to the following definitions:

- (i) "Non-profit organisations" are organisations not allowed by their legal form or statutes, under the relevant law, to be a source of income, profit or other financial gain to their owners, or – if allowed to make a profit – there is a legal or statutory obligation to reinvest the profits made in the interest of the organisation.
- (ii) "Universities" are to be understood as “classical” universities, meaning institutions of higher education and research, under the relevant law. However, comparable entities, such as secondary or higher education establishments, will be considered to be universities.
- (iii) "Public research organisations" are entities such as universities or research institutes that are organised under public law and, irrespective of how they are financed, have the primary goal of conducting fundamental research, industrial research or experimental development and of disseminating the results by

way of teaching, publication or technology transfer. All profits must be reinvested in carrying out these activities, in disseminating the results or in teaching.

If there are multiple applicants, each one must be an entity or a natural person within the meaning of Rule 6(4) for the fee reduction to apply. *Rule 6(7)*

Applicants wishing to benefit from the reduction in the filing or examination fee under Art. 14(1) RFees must expressly declare that they are an entity or natural person covered by Rule 6(4) EPC. *Rule 6(6)*

Changes in the status of an entity under Rule 6(4) which occur after filing the declaration will not have a retroactive effect on fee reductions that were justified when granted.

The Office will conduct random checks to ensure compliance with the eligibility criteria laid down in Rule 6(3) to (7). If those checks give rise to reasonable doubt during the course of the grant proceedings as to the veracity of the declaration given by the applicant, the EPO may request appropriate evidence.

Should it become apparent that an incorrect declaration has been filed, the fee would not be validly paid since it was reduced unjustifiably and the application will be deemed withdrawn under Art. 78(2) and 94(2). The same applies if no declaration has been filed. The loss of rights arising from an incorrect or missing declaration may be remedied by filing a request for further processing under Art. 121 and Rule 135 – subject to making good the underpayment and paying the fee for further processing – or by requesting a decision under Rule 112(2).

In respect of European patent applications, oppositions, appeals, petitions for review or requests for limitation or revocation filed before 1 April 2014, and international applications having entered the European phase before that date, the fee reduction in force until then will apply.

---

### 9.2.2 Reduction of the filing fee

In the case of the filing of the European application, the presence of a description is necessary for the accordance of a date of filing (Rule 40(1)(c)), but claims are no longer required for this. According to J 4/88, only the description and claims needed to be in this language to qualify for the fee reduction (not the Request for grant for example). However, since claims are no longer required for a date of filing, the essential element is now the description.

Consequently, the filing fee is reduced if the European patent application (i.e. at least the description) is filed in an admissible non-EPO language (i.e. an official language of a Contracting State which is not an official language of the EPO).

---

Where the application is filed by reference to a previously filed application (see A-II, 4.1.3.1), and the previously filed application referred to, is in an admissible non-EPO language and the applicant satisfies the eligibility criteria mentioned in A-X, 9.2.1, then the applicant is also entitled to the reduction in the filing fee. For the purposes of the reduction, it does not matter whether or not the applicant requested that the claims of the previously filed application take the place of the claims in the application as filed (see above).

The reduction of the filing fee is also applicable to divisional applications if the parent application was filed in an admissible non-EPO language (see A-IV, 1.3.3, and A-X, 9.2.1) and the divisional application is filed in the same admissible non-EPO language as the earlier application (Rule 36(2) and Rule 6(3)), provided that the other requirements for the reduction are met (see above) and a translation is filed in time (see A-X, 9.2.1).

Since the additional fees payable if the application comprises more than thirty-five pages or if it is a second- or further generation divisional application form part of the filing fee, the reduction applies also to them.

### 9.2.3 Reduction of the examination fee

Applicants eligible for the fee reduction will be allowed a reduction in the examination fee if the request for examination is filed in an admissible non-EPO language. Forms 1001 (Request for grant of a European patent) and 1200 (Entry into the European phase) contain pre-printed boxes where the request for examination in an admissible non-EPO language and the declaration under Rule 6(6) can be entered. In these cases, the filing of a translation of the request is not necessary, since the written request for examination in the three EPO official languages is pre-crossed in the same forms. Wordings for the request-for-examination in the admissible non-EPO languages are listed on the EPO website. Subsequent documents related to examination proceedings need not be filed in the admissible non-EPO language.

If the conditions for the reduction of the examination fee where the EPO has drawn up the international preliminary examination report are also fulfilled, see A-X, 9.3.2.

## 9.3 Special reductions

### 9.3.1 Reduction of the search fee for a supplementary European search

The search fee for a supplementary European search report is reduced for PCT applications for which the Patent Office of the USA, Japan, China, Australia, Russia or Korea was the International Searching Authority. In these cases, the supplementary search fee is reduced by a fixed amount (see OJ EPO 2005, 548).

Art. 14(4)  
Rule 6

Art. 153(7)

The search fee for a supplementary European search report is also reduced by a fixed amount for PCT applications for which the Patent Office of Austria, Finland, Spain or Sweden or the Nordic Patent Institute was the International Searching Authority or where one of these offices prepared the supplementary international search report (see Decisions of the Administrative Council of 27 October 2011, OJ EPO 2011, 616; and of 25 October 2012, OJ EPO 2012, 584).

It is to be noted that in each case where the requirements for fee reduction are fulfilled the fee reduction is granted only once, i.e. for the supplementary search fee paid under Rule 159(1)(e). The reduction applies independently of whether the first invention in the claims was searched by the ISA in the international phase. The reduction does not apply to any further search fee (to be) paid under Rule 164(1).

PCT applications for which the International Searching Authority was other than the ones mentioned in the paragraphs above do not qualify for any reduction in the supplementary search fee (see OJ EPO 2012, 212).

### **9.3.2 Reduction of the examination fee where the international preliminary examination report is being drawn up by the EPO**

Where the EPO has drawn up the international preliminary examination report in respect of an international application, the examination fee is reduced by 50% if the EPO is the designated Office (elected Office).

*Art. 14(2) RFees*

If the conditions for a reduction under the language arrangements (see A-X, 9.2.3) are also fulfilled, the examination fee is first reduced by 50%, then by a further 30%, i.e. the total reduction is 65% of the full fee.

### **9.3.3 Reduction of the fees for the international search and international preliminary examination of an international application**

The fees for the international search and preliminary examination of an international application are reduced by 75% if the application is filed by a natural person who is a national and a resident of a state which is not an EPC Contracting State and which, on the date of filing of the application or of the demand, is listed as a low-income or lower-middle-income economy by the World Bank (see OJ EPO 2008, 521).

## **10. Refund of fees**

### **10.1 General remarks**

#### **10.1.1 Fee payments lacking a legal basis**

There are two conditions for a fee payment to be fully valid:

- (i) the payment must relate to proceedings that are pending; and

- (ii) the date of payment (see A-X, 4) must be on or after the due date (see A-X, 5.1.1).

If a payment does not relate to a pending European patent application (e.g. it relates to a patent application already deemed to have been withdrawn), there is no legal basis for the payment; the amount paid must be refunded.

If the payment is made before or on the due date and if, no later than that date, the legal basis ceases to exist (e.g. because the patent application is deemed to be withdrawn or is withdrawn), the amount paid is to be refunded. This also applies to renewal fees validly paid before the due date (Rule 51(1), second sentence).

### **10.1.2 Fee payments which are not valid**

If fees have not been validly paid they must be refunded. Examples: filing fee, search fee, designation fee or examination fee paid late, as laid down under the provisions relating to further processing (Art. 121 and Rule 135), without the further processing fee required by Rule 135(1) and Art. 2(1), No. 12 RFees. Fees paid on or after the due date are refunded only if there is a particular reason for a refund (see A-X, 10.2).

### **10.1.3 Insignificant amounts**

*Art. 12 RFees*

Where the sum paid is larger than the fee, the excess will not be refunded if the amount is insignificant and the party concerned has not expressly requested a refund. It has been decided that any amount up to EUR 10 constitutes an insignificant amount (Art. 1 of the Decision of the President of the EPO dated 12 July 2007, Special edition No. 3, OJ EPO 2007, M.3).

## **10.2 Special refunds**

### **10.2.1 Refund of the search fee**

*Art. 9 RFees*

The search fee for a European or supplementary European search is refunded in cases provided for in Art. 9 RFees and in the Decision of the President of the EPO dated 24 March 2010, OJ EPO 2010, 338, which applies to European patent applications in respect of which the European or supplementary European search is completed on or after 1 July 2010. Details on criteria for refund of search fees are given in the Notice from the EPO dated 9 January 2009, OJ EPO 2009, 99.

For the purposes of Art. 9(1) RFees, the date of the start of the search is indicated in the public part of the dossier and is thus open to file inspection in the European Patent Register after publication of the patent application (see also B-IV, 1). Before publication, the EPO will provide the applicant with the relevant information upon request, or this information can be accessed electronically via the MyFiles service.

**10.2.2 Refund of the further search fee**

If an applicant, following a communication from the Search Division, has paid a further search fee but the Examining Division, at the applicant's request, has found that there was no justification for charging the further search fee, the latter will be repaid. The same principle applies if the applicant has paid a search fee on the basis of an invitation by the Examining Division in accordance with Rule 164(2) (see C-III, 2.3). In such case the Examining Division will, on request, review the justification for charging the search fee in its invitation under Rule 164(2) (see C-III, 3.3).

*Rule 64(2), 164(5)*

**10.2.3 Refund of the international search fee**

The international search fee will be refunded in the cases specified in Rules 16.2, 16.3 and 41 PCT and in Annex C of the Agreement between the European Patent Organisation and the International Bureau of the World Intellectual Property Organization (WIPO) under the PCT (see OJ EPO 2010, 304). Following amendment of the provisions set out in Annex C, Part II(3) of the above mentioned agreement, any refund of the international search fee paid for an international application will be granted to the extent set out in the Decision of the President of the EPO dated 24 March 2010, OJ EPO 2010, 341, for international applications for which the international search report is completed on or after 1 July 2010. Details on the criteria for the refund of international search fees are given in the Notice from the EPO dated 9 January 2009, OJ EPO 2009, 99.

*Rule 16.2 and  
16.3 PCT  
Rule 41 PCT*

**10.2.4 Refund of the examination fee**

The examination fee will be refunded in the situations described in Art. 11 RFees (see A-VI, 2.2, 3rd paragraph, and A-VI, 2.5).

*Art. 11 RFees*

**10.2.5 Refund of the international preliminary examination fee**

For international applications filed on or after 1 January 2004 the EPO has discontinued the rationalised international preliminary examination procedure (see OJ EPO 2001, 539). Consequently, no request for "detailed" examination will be required, and the fee refund for the rationalised procedure is no longer available.

**10.2.6 Refund pursuant to Rule 37(2)**

If a European patent application filed with a competent national authority is deemed to be withdrawn pursuant to Art. 77(3), all fees, in particular the filing, search and designation fees and any claims fees paid, will be refunded.

*Rule 37(2)*

**10.2.7 Refund of the fee for grant and publishing**

If the application is refused, withdrawn prior to notification of the decision on the grant of a European patent or, at that time, deemed to be withdrawn, the fee for grant and publishing shall be refunded. The date of notification of the decision is determined as indicated in E-I, 2. Note that this date is later than the date on which the decision is handed over to the EPO internal postal service (i.e. decision G 12/91 does not apply in this case).

*Rule 71a(6)*

This may happen, for example, where the applicant pays the fee for grant and publishing within the Rule 71(3) period but does not pay the claims fees which are due and/or neglects to file the translations of the claims, leading to deemed withdrawal of the application under Rule 71(7) (see C-V, 3).

Where the application is refused, the refund will be effected only after the period for filing of an appeal has expired without an appeal having been filed (see E-X, 6). Where the application is deemed to be withdrawn, the refund will be effected only after the period for requesting further processing has expired and this has not been requested by the applicant (see E-VII, 2.1).

### **10.3 Method of refund**

If the person to whom the refund is payable holds a deposit account with the EPO, the refund shall take the form of crediting that deposit account. Otherwise refunds will be made by means of a cheque.

### **10.4 Person to whom refund is payable**

Fees will be refunded to the party concerned. However, if the party's representative is authorised to receive payments, the refund will be made to the representative. A refund will not be made to a third party who paid the fee, except where this relates to the fee for file inspection.

It is not incumbent upon the EPO to ascertain whether there are legal grounds, arising out of the relations between the party or his representative and the person who made the payment, for making the refund direct to the latter. Consequently, a refund will be made direct to the person who made the payment only if the purpose of the payment cannot immediately be established and the person who made the payment fails, on request, to notify the EPO of that purpose in due time. Since the proceedings to which it relates cannot be identified, the fee will be considered not to have been paid (Art. 6(2) RFees).

### **10.5 Re-allocation instead of refund**

If a party files a written request, the payment may be re-allocated instead of being refunded. The date of receipt of the re-allocation instructions is then considered to be the date of payment for the new purpose of payment.

## **11. Crediting of fees under Rule 71a(5)**

*Rule 71a(5)*

If, in response to an invitation under Rule 71(3), the applicant has already paid the fee for grant and publishing or the claims fees, the amount paid shall be credited if a further such invitation is issued. This may happen where:

- (i) the applicant requests amendments or corrections in response to the first Rule 71(3) communication or requests the reversal of amendments proposed by the Examining Division in that communication (see C-V, 4.1) and he also voluntarily pays the fee for grant and publishing and claims fees (even though this is



not required, C-V, 4.2); and the Examining Division then issues a subsequent Rule 71(3) communication (see C-V, 4.6 and 4.7.2), or

- (ii) after the applicant has approved the text for grant in response to the first Rule 71(3) communication (which requires payment of the fee for grant and publishing and any claims fees due - see C-V, 1.1), examination is resumed (see C-V, 6.1) leading to the issuance of a subsequent Rule 71(3) communication (see C-V, 6.2).

### **11.1 Crediting of the fee for grant and publishing**

The amount of the fee for grant and publishing paid in response to the first Rule 71(3) communication is credited towards the amount of this same fee due in response to the second Rule 71(3) communication. If there is an increase in this fee between the first and second Rule 71(3) communications, the difference must be paid within the period for reply to the second Rule 71(3) communication.

For European applications filed before 1 April 2009 or international applications entering the European phase before that date, the fee for grant and publishing incorporates a fixed component and a component in respect of each page of the application over and above 35 (see C-V, 1.2 and A-III, 13.2). If the overall fee changes between the first and the second Rule 71(3) communication, any shortfall must be paid within the second Rule 71(3) period (e.g. resulting from a fee increase or an increase in the number of pages). Any excess will be refunded (for example where the version of the application on which the second Rule 71(3) communication is based has fewer pages than the earlier version on which the first Rule 71(3) communication was based).

*Art. 2(2), No. 7 RFees*

### **11.2 Crediting of claims fees**

The amount of the claims fees paid in response to the first Rule 71(3) communication is credited towards the amount of the claims fees due in response to the second Rule 71(3) communication. In this regard it is important to note that, unlike claims fees paid on filing under Rule 45 or on entry into the European phase under Rule 162, it is not the number of claims paid for which is used in the calculation, but rather the amount paid.

If the amount of the claims fees due increases between the first and second Rule 71(3) communications (e.g. because there is an increase in the fee per claim or an increase in the number of claims or both), the difference must be paid within the period for reply to the second Rule 71(3) communication.

In order to calculate the amount of the claims fees due in response to the second Rule 71(3) communication, the number of fee-free claims (15) and also the number of claims fees paid on filing or on entry into the European phase are deducted from the number of claims on which

both the first and second Rule 71(3) communications are based. Thereafter, the amount of the claims fees paid in response to the first Rule 71(3) communication is then credited towards (and so deducted from) the amount of the claims fees due in response to the second Rule 71(3) communication (if the amount of fees due after the second Rule 71(3) communication is smaller than that voluntarily paid after the first Rule 71(3) communication, see C-V, 4.2).

### **11.3 Separate crediting of the fee for grant and publishing and claims fees**

The crediting of claims fees and the fee for grant and publishing is dealt with separately. Claims fees are not credited towards any increase in the fee for grant and publishing.

### **11.4 Further processing fee and crediting of fees**

Where the applicant has requested further processing in respect of the first Rule 71(3) communication (see E-VII, 2.1), the fee for further processing is not credited towards any increase in the amount of the fees due in response to the second Rule 71(3) communication.

Furthermore, the fee for further processing paid in respect of the first Rule 71(3) communication is also not credited to any subsequent request for further processing in respect of the second Rule 71(3) communication.

## Chapter XI – Inspection of files; communication of information contained in files; consultation of the Register of European Patents; issuance of certified copies

### 1. General

Provision is made for inspection of files and communication to the public of information contained in files. This applies to the files of European patent applications and European patents.

*Art. 128*

For international (PCT) applications, see E-VIII, 2.11.

The provisions governing inspection of files are contained in Art. 128 and Rules 144 and 145, those for communication of information in Rule 146.

*Rule 144, Rule 145  
Rule 146*

The fee for inspection of files and the fee for communication of information contained in files are laid down by the President pursuant to Art. 3(1) RFees and are regularly published in the Official Journal.

*Art. 3(1) RFees*

### 2. Inspection of files

#### 2.1 Extent of file inspection

Inspection of the files of European patent applications and of European patents is granted in respect of the original documents or of copies thereof or, if the files are stored on other media, in respect of these media. All parts of the file compiled when conducting the examination, opposition and appeal procedure with the parties are open for inspection. It also includes information on the dates of the start of search and examination, any invitations under Rule 63(1) or Rule 62a(1) and the search opinion if applicable.

*Rule 145(1)  
Rule 147(2)*

Observations by third parties (Art. 115) are an integral part of the files and as such are open to inspection in accordance with Art. 128. If a third party asks that his observations or a part thereof be treated confidentially, that request cannot be granted and the third party will be notified accordingly.

The parts of the file excluded from inspection are:

*Art. 128(4)*

- (i) the documents relating to the exclusion of or objections to members of the Boards of Appeal or of the Enlarged Board of Appeal;

*Rule 144(a)*

- |   |  |
|---|--|
| <i>Rule 144(b)</i>                          | (ii) draft decisions and opinions, and all other documents, used for the preparation of decisions and opinions, which are not communicated to the parties;   |
| <i>Rule 144(c)</i>                          | (iii) the designation of the inventor if he has waived his right to be mentioned as inventor under Rule 20(1);   |
| <i>Rule 144(d)</i>                          | (iv) any other document excluded from inspection by the President of the EPO on the ground that such inspection would not serve the purpose of informing the public about the European patent application or the resulting patent. These documents include documents relating to file inspection and requests for accelerated search and accelerated examination under the "PACE" programme (if submitted using Form 1005 or in a separate document) (see the Decision of the President of the EPO dated 12 July 2007, Special edition No. 3, OJ EPO 2007, J.3); |
| <i>Art. 38(1) PCT</i><br><i>Rule 94 PCT</i> | (v) subject to Rules 94.2 and 94.3 PCT, the files of the international preliminary examination for a Euro-PCT application in respect of which the EPO is the international preliminary examining authority and for which an international preliminary examination report has not yet been established (see OJ EPO 2003, 382; see also E-VIII, 2.11).   |

The parts of the file excluded from inspection are kept separate in the files from those open to inspection.

## 2.2 Procedure for file inspection

- |                    |  |
|--------------------|--|
| <i>Rule 145(2)</i> | The President of the EPO determines all file inspection arrangements, including the circumstances in which an administrative fee is payable (see the Decisions of the President of the EPO dated 12 July 2007, Special edition No. 3, OJ EPO 2007, J.2). |
|--------------------|--|

Files that are available in electronic form can be inspected free of charge online via the Register Plus online service (see also the above mentioned Decision of the President of the EPO).

Other forms of file inspection, e.g. by furnishing paper copies, are available on request. No particular form is prescribed for the request, except that it must be filed in writing with the EPO at one of its filing offices. The EPO offers a form via its website on the Internet. The request should contain information about the payment of the fee. Requests filed by fax (see A-VIII, 2.5) or submitted through the Internet will be processed without confirmation.

- |                    |  |
|--------------------|--|
| <i>Rule 145(2)</i> | A fee, if any, falls due when the request is received. The method of payment and date on which payment is deemed to have been made are dealt with in the Rules relating to Fees (see A-X). Where the administrative fee has been duly paid, it will not be refunded. |
|--------------------|--|

### 2.3 Restrictions to file inspection

Subsequent to the publication of the European patent application any person may inspect and obtain information from the files. Inspection of files and communication of information are subject to the restrictions laid down in Rule 144 (see A-XI, 2.1). If it is decided that certain papers marked "confidential" are not to be excluded from file inspection under Rule 144, they are returned to the sender (see T 516/89).

*Art. 128(4)*  
*Rule 146*  
*Rule 145*  
*Rule 144*

### 2.4 Confidentiality of the request

Correspondence from the proceedings relating to the inspection of files conducted between the EPO and the person requesting the inspection is filed in the non-public part of the file. The EPO does not provide the applicant with any information about the proceedings relating to the inspection of files (see, however, A-XI, 2.5, third paragraph).

### 2.5 File inspection before publication of the application

Until such time as the European patent application is published, the files may be inspected only by the applicant or with his consent. Secure File Inspection allows the applicant to inspect online the public part of the files relating to his own as yet unpublished application (see Notice from the EPO dated 13 December 2011, OJ EPO 2012, 22). If a third party requests file inspection without at the same time submitting the applicant's consent, the EPO will not release the files until the applicant's approval has been presented.

*Art. 128(1)*

However, prior to publication of the European patent application, any person who can prove that the applicant has invoked his rights under the application against him may also inspect the files. The rights under a European patent application are also deemed to have been invoked where rights under a first filing in a Contracting State have been invoked and the subsequent European application is mentioned at the same time (see J 14/91). If such proof is not furnished together with the request, the EPO will invite the requester within a specified period to supply proof. If he fails to do so in due time, the request will be refused.

*Art. 128(2)*

In case of a request for inspection of the files under Art. 128(2), the applicant is entitled to notification of the identity of the person making the request. Professional representatives requesting inspection of the files on behalf of a third party pursuant to Art. 128(2) must accordingly give the third party's name and address and file an authorisation.

A decision on a request for inspection of the files pursuant to Art. 128(2) is only taken once the applicant has been heard. If the applicant objects and provides grounds for his belief that the requirements under Art. 128(2) are not met within the period set by the EPO, a decision will be delivered. This decision is subject to appeal.

Prior to publication of a European divisional application the file of this divisional application may only be inspected in the cases described in Art. 128(1) and (2). This also applies where the parent application has already been published. However, where a European divisional

*Art. 128(3)*

application or a new European patent application filed under Art. 61(1)(b) is published, the files of the earlier application may be inspected prior to the publication of that earlier application and without the consent of the relevant applicant.

### **2.6 Publication of bibliographic data before publication of the application**

*Art. 128(5)* The EPO has not hitherto availed itself of the power under Art. 128(5) to publish bibliographic data before the European patent application is published.

### **3. Communication of information from the files**

*Rule 146* Subject to the restrictions provided for in Art. 128(1) to (4) and Rule 144, the EPO may, upon request, communicate information concerning any file of a European patent application or European patent. This may be subject to the payment of an administrative fee.

However, the EPO may require the exercise of the option to obtain inspection of the file itself, should it deem this to be appropriate in view of the quantity of information to be supplied.

Correspondence from the proceedings relating to the communication of information conducted between the EPO and the person requesting the information is filed in the part of the file which is not accessible to the public. The EPO does not provide the applicant with any information about the proceedings relating to the communication of information.

### **4. Consultation of the European Patent Register**

*Art. 127*  
*Rule 143* The European Patent Register, containing the particulars specified in Rule 143, may be consulted in order to ascertain the state of the proceedings and the legal status of patent rights. Entries are made in the European Patent Register up to expiry of the period of opposition or the termination of opposition proceedings. Where applicable, the date and purport of any decision taken in revocation or limitation proceedings (Art. 105b(2)) and/or on a petition for review (Art. 112a) are also included (Rule 143(1)(x) and (y)). The correction of the designation of the inventor, may be made at any time. The Online European Patent Register can be accessed free of charge via the Internet (<https://register.epo.org>). Apart from the data entered in the European Patent Register, the Online Register includes additional application and procedural data not published in the European Patent Bulletin. Register data may also be obtained by telephone from the customer services in Munich, The Hague, Berlin or Vienna:

<http://www.epo.org/service-support/contact-us.html>.

### **5. Certified copies**

The EPO will issue on request a certified copy of the European patent application or European patent specification, of other documents from the files of European applications and patents, provided that the

conditions for file inspection (Art. 128(1) to (4)) are fulfilled and, where necessary, an administrative fee has been paid.

Costs incurred in preparing the copies certified will be charged to the requester.

If it is indicated, when the request is filed, that the cost should be debited from the requester's deposit account, the amount of the invoice will be charged to the deposit account.

#### **6. Priority documents issued by the EPO**

Any priority document (i.e. the certified copy of the European application together with the certificate stating the date of filing thereof) will only be issued to the (original) applicant or his successor in title. In the case of applications filed in a language other than an official language of the EPO (Art. 14(2)), the priority document relates to the application as originally filed, not to the translation in one of the official languages of the EPO.

*Rule 54*

The President of the EPO determines all necessary arrangements, including the form of the priority document and the circumstances in which an administrative fee is payable.





# **Part B**

## **Guidelines for Search**



# Contents

## **Chapter I – Introduction I-1**

- 1. Purpose of Part B I-1**
- 2. Search Division I-1**
  - 2.1 Consultation with other examiners I-1
  - 2.2 Search Division consisting of more than one examiner I-1

## **Chapter II – General II-1**

- 1. Search and substantive examination II-1**
- 2. Objective of the search II-1**
- 3. Search documentation II-1**
- 4. Search report II-1**
  - 4.1 European searches II-2
  - 4.2 Additional European searches II-2
  - 4.3 Supplementary European searches II-2
    - 4.3.1 Dispensing with the supplementary European search report II-3
    - 4.3.2 A supplementary European search report is required II-3
    - 4.3.3 Application documents for the supplementary European search report II-4
  - 4.4 International (PCT) searches II-4
  - 4.5 International-type searches II-5
  - 4.6 Searches on national applications II-5

## **Chapter III – Characteristics of the search III-1**

- 1. Opinions of the Search Division III-1**
  - 1.1 Opinions in relation to the search report III-1
  - 1.2 Opinions on matters relating to the limitation of the search III-1

---

<b>2.</b>	<b>Scope of the search</b>	<b>III-1</b>
2.1	Completeness of the search	III-1
2.2	Effectiveness and efficiency of the search	III-2
2.3	Search in analogous fields	III-2
2.4	Search on the internet	III-3
<b>3.</b>	<b>The subject of the search</b>	<b>III-3</b>
3.1	Basis for the search	III-3
3.2	Interpretation of claims	III-3
3.2.1	Claims with explicit references to the description or drawings	III-4
3.3	Amended claims or missing parts (Rule 56)	III-5
3.3.1	General considerations	III-5
3.3.2	Specific rules applicable to Euro-PCT applications	III-5
3.4	Abandonment of claims	III-5
3.5	Anticipation of amendments to claims	III-6
3.6	Broad claims	III-6
3.7	Independent and dependent claims	III-7
3.8	Search on dependent claims	III-8
3.9	Combination of elements in a claim	III-8
3.10	Different categories	III-8
3.11	Subject-matter excluded from search	III-8
3.12	Lack of unity	III-9
3.13	Technological background	III-9
<b>Chapter IV – Search procedure and strategy</b>		<b>IV-1</b>
<b>1.</b>	<b>Procedure prior to searching</b>	<b>IV-1</b>
1.1	Analysis of the application	IV-1
1.2	Formal deficiencies	IV-1
1.3	Documents cited or supplied by the applicant	IV-2

---

<b>2.</b>	<b>Search strategy</b>	<b>IV-3</b>
2.1	Subject of the search; restrictions	IV-3
2.2	Formulating a search strategy	IV-4
2.3	Carrying out the search; types of documents	IV-4
2.4	Reformulation of the subject of the search	IV-6
2.5	Closest prior art and its effects on the search	IV-6
2.6	End of search	IV-7
<b>3.</b>	<b>Procedure after searching</b>	<b>IV-7</b>
3.1	Preparation of the search report	IV-7
3.2	Documents discovered after completion of the search	IV-8
3.3	Errors in the search report	IV-8
<b>Chapter V – Preclassification (routing) and official classification of European patent applications</b>		<b>V-1</b>
<b>1.</b>	<b>Definitions</b>	<b>V-1</b>
<b>2.</b>	<b>Preclassification (routing and distribution)</b>	<b>V-1</b>
<b>3.</b>	<b>Incorrect preclassification</b>	<b>V-1</b>
<b>4.</b>	<b>Official classification of the application</b>	<b>V-2</b>
<b>5.</b>	<b>Classification of late-published search reports</b>	<b>V-2</b>
<b>6.</b>	<b>Classification when the scope of the invention is not clear (e.g. a partial search)</b>	<b>V-3</b>
<b>7.</b>	<b>Classification in cases of a lack of unity of invention</b>	<b>V-3</b>
<b>8.</b>	<b>Verification of official classification</b>	<b>V-3</b>
<b>Chapter VI – The state of the art at the search stage</b>		<b>VI-1</b>
<b>1.</b>	<b>General</b>	<b>VI-1</b>

---

<b>2.</b>	<b>State of the art – oral disclosure, etc.</b>	<b>VI-1</b>
<b>3.</b>	<b>Priority</b>	<b>VI-1</b>
<b>4.</b>	<b>Conflicting applications</b>	<b>VI-1</b>
4.1	Potentially conflicting European and international applications	VI-1
4.2	National earlier rights	VI-1
<b>5.</b>	<b>Date of reference for documents cited in the search report; filing and priority date</b>	<b>VI-2</b>
5.1	Verification of claimed priority date(s)	VI-2
5.2	Intermediate documents	VI-2
5.3	Doubts as to the validity of the priority claim; extension of the search	VI-2
5.4	Documents published after the filing date	VI-3
5.5	Non-prejudicial disclosures	VI-4
5.6	Matters of doubt in the state of the art	VI-4
<b>6.</b>	<b>Contents of prior-art disclosures</b>	<b>VI-5</b>
6.1	General remark	VI-5
6.2	Citation of documents corresponding to documents not available or not published in one of the official EPO languages	VI-5
6.3	Conflict between abstract and source document	VI-6
6.4	Insufficient prior art disclosures	VI-6
6.5	Incorrect compound records in online databases	VI-6
<b>7.</b>	<b>Internet disclosures - technical journals</b>	<b>VI-7</b>
<b>Chapter VII – Unity of invention</b>		<b>VII-1</b>
<b>1.</b>	<b>General remarks</b>	<b>VII-1</b>
1.1	Partial European search report	VII-1
1.2	Invitation to pay further search fees	VII-1
1.3	Documents relevant only to other inventions	VII-2

1.4	Assessment and possible review of the unity requirement	VII-2
<b>2.</b>	<b>Procedures in cases of lack of unity</b>	<b>VII-2</b>
2.1	Request for refund of further search fee(s)	VII-2
2.2	Complete search despite of lack of unity	VII-3
2.3	Supplementary European search	VII-3
<b>3.</b>	<b>Lack of unity and Rule 62a or Rule 63</b>	<b>VII-3</b>

## **Chapter VIII – Subject-matter to be excluded from the search**

**VIII-1**

<b>1.</b>	<b>General remarks</b>	<b>VIII-1</b>
<b>2.</b>	<b>Considerations relating to certain technical fields</b>	<b>VIII-1</b>
2.1	Methods for treatment of the human or animal body by surgery or therapy and diagnostic methods practised on the human or animal body	VIII-1
2.2	Computer-implemented inventions and business methods	VIII-2
<b>3.</b>	<b>No meaningful search possible</b>	<b>VIII-2</b>
3.1	Invitation to indicate subject-matter for search	VIII-5
3.2	Reply to the invitation under Rule 63(1)	VIII-5
3.2.1	Failure to reply in time or no reply	VIII-5
3.2.2	Reply in time	VIII-5
3.3	The content of the extended European search report (EESR)	VIII-7
3.4	Applications to which Rule 63 applies which also lack unity	VIII-7
<b>4.</b>	<b>More than one independent claim per category (Rule 62a)</b>	<b>VIII-8</b>
4.1	Invitation to indicate which independent claim to search	VIII-8
4.2	Reply to the invitation under Rule 62a(1)	VIII-8
4.2.1	Failure to reply in time	VIII-8
4.2.2	Reply filed in time	VIII-9

4.3	The content of the extended European search report (EESR)	VIII-10
4.4	Cases under Rule 62a where claims fees are not paid	VIII-10
4.5	Applications to which Rule 62a applies which also lack unity	VIII-10
4.6	Treatment of dependent claims under Rule 62a	VIII-11
<b>5.</b>	<b>Invitation under both Rule 62a(1) and Rule 63(1)</b>	<b>VIII-11</b>
<b>6.</b>	<b>Claims contravening Art. 123(2) or Art. 76(1)</b>	<b>VIII-12</b>

## **Chapter IX – Search documentation** **IX-1**

<b>1.</b>	<b>General</b>	<b>IX-1</b>
1.1	Organisation and composition of the documentation available to the Search Divisions	IX-1
1.2	Systematic access systems	IX-1
<b>2.</b>	<b>Patent documents arranged for systematic access</b>	<b>IX-1</b>
2.1	PCT minimum documentation	IX-1
2.2	Unpublished patent applications	IX-1
2.3	Search reports	IX-2
2.4	Patent family system	IX-2
<b>3.</b>	<b>Non-patent literature arranged for systematic access</b>	<b>IX-2</b>
3.1	Periodicals, records, reports, books, etc.	IX-2
<b>4.</b>	<b>Non-patent literature arranged for library-type access</b>	<b>IX-2</b>
4.1	Composition	IX-2
<b>5.</b>	<b>Access to EPO documentation for the national patent offices</b>	<b>IX-3</b>



<b>Chapter X – Search report</b>	<b>X-1</b>
<b>1. General</b>	<b>X-1</b>
<b>2. Different types of search reports drawn up by the EPO</b>	<b>X-2</b>
<b>3. Form and language of the search report</b>	<b>X-2</b>
3.1 Form	X-2
3.2 Language	X-3
3.3 Account of the search	X-3
<b>4. Identification of the patent application and type of search report</b>	<b>X-3</b>
<b>5. Classification of the patent application</b>	<b>X-4</b>
<b>6. Areas of technology searched</b>	<b>X-4</b>
<b>7. Title, abstract and figure(s) to be published with the abstract (as indicated on supplemental sheet A)</b>	<b>X-4</b>
<b>8. Restriction of the subject of the search</b>	<b>X-6</b>
<b>9. Documents noted in the search</b>	<b>X-6</b>
9.1 Identification of documents in the search report	X-6
9.1.1 Bibliographic elements	X-6
9.1.2 "Corresponding documents"	X-7
9.1.3 Languages of the documents cited	X-9
9.1.4 Supplementary European search report	X-10
9.2 Categories of documents (X, Y, P, A, D, etc.)	X-10
9.2.1 Particularly relevant documents	X-11
9.2.2 Documents defining the state of the art and not prejudicing novelty or inventive step	X-11
9.2.3 Documents which refer to a non-written disclosure	X-11
9.2.4 Intermediate documents	X-11
9.2.5 Documents relating to the theory or principle underlying the invention	X-12
9.2.6 Potentially conflicting patent documents	X-12
9.2.7 Documents cited in the application	X-12
9.2.8 Documents cited for other reasons	X-12
9.3 Relationship between documents and claims	X-13
9.4 Identification of relevant passages in prior art documents	X-13

<b>10.</b>	<b>Authentication and dates</b>	<b>X-14</b>
<b>11.</b>	<b>Copies to be attached to the search report</b>	<b>X-14</b>
11.1	General remarks	X-14
11.2	Electronic version of document cited	X-14
11.3	Patent family members; the "&" sign	X-14
11.4	Reviews or books	X-14
11.5	Summaries, extracts or abstracts	X-15
11.6	Citation of video and/or audio media fragments available on the internet	X-15
<b>12.</b>	<b>Transmittal of the search report and search opinion</b>	<b>X-15</b>
<b>Chapter XI – The search opinion</b>		<b>XI-1</b>
<b>1.</b>	<b>Search opinion is part of the EESR</b>	<b>XI-1</b>
1.1	The search opinion	XI-1
1.2	Position of the Examining Division	XI-1
<b>2.</b>	<b>Basis of the search opinion</b>	<b>XI-1</b>
2.1	Applications containing missing parts of description and/or drawings filed under Rule 56 EPC or Rule 20 PCT	XI-2
2.2	Applications containing claims filed after the accorded date of filing	XI-3
<b>3.</b>	<b>Analysis of the application and content of the search opinion</b>	<b>XI-3</b>
3.1	The examiner's dossier	XI-4
3.2	Reasoned objections	XI-4
3.3	Comments and amendments in response to the search opinion	XI-4
3.4	Extent of first analysis	XI-4
3.5	Contribution to the known art	XI-5
3.6	EPC requirements	XI-5

---

3.7	Examiner's approach	XI-5
3.8	Making suggestions	XI-6
3.9	Positive opinion	XI-6
<b>4.</b>	<b>Priority claim and the search opinion</b>	<b>XI-7</b>
4.1	Use of "P" and "E" documents in the search opinion	XI-7
<b>5.</b>	<b>Unity in relation to the search opinion</b>	<b>XI-8</b>
<b>6.</b>	<b>The search opinion in cases of a limitation of the search</b>	<b>XI-8</b>
<b>7.</b>	<b>No search opinion is issued</b>	<b>XI-9</b>
<b>8.</b>	<b>Reaction to the extended European search report (EESR)</b>	<b>XI-9</b>
<b>9.</b>	<b>Art. 124 and the utilisation scheme</b>	<b>XI-11</b>



## Chapter I – Introduction

### 1. Purpose of Part B

Part B was drafted for, and applies to, European searches, i.e. searches performed by the EPO for European applications. In addition to these searches the Search Divisions of the EPO are called upon to carry out other types of searches (see B-II, 4). Searches in the context of the Patent Co-operation Treaty (PCT) are dealt with in the PCT Search and Examination Guidelines.

### 2. Search Division

The unit within the EPO responsible for carrying out the search and drawing up the search report for an application is a Search Division, which consists normally of one examiner. The examiner responsible for the search on a European application is also normally the first member of the Examining Division for that application.

*Art. 17*

*Art. 18*

In this Part B, the term "examiner" is used to mean the examiner entrusted with the search within the Search Division which is responsible for drawing up the search report and the search opinion (see B-XI).

#### 2.1 Consultation with other examiners

The examiner entrusted with the search may consult other examiners for advice on any number of issues, for example:

- (i) online searches in databases with which the examiner is not familiar;
- (ii) understanding aspects of the claimed invention which may lie outside the area of technical expertise of the examiner concerned;
- (iii) constructing a search strategy;
- (iv) interpreting the relevance of a prior-art document for determining the patentability of claimed subject-matter (see B-X, 9.2).

#### 2.2 Search Division consisting of more than one examiner

Where the invention is of a nature requiring searching in widely dispersed specialised fields, a special Search Division consisting of two, or possibly three, examiners may be formed, for example, where the "person skilled in the art" in the technical field of the application consists of more than one person (see G-VII, 3).

Another case is where there is found to be a lack of unity in subject-matter between different technical fields.

In such cases, the documents found in the different technical fields by the first and by the other examiner(s) are included in the same search report. The search opinion however is prepared by one examiner only, if necessary in consultation with the examiner expert(s) in the other technical field(s).

## Chapter II – General

### 1. Search and substantive examination

The procedure through which a European patent application proceeds from the filing of the application to the grant of a patent (or the refusal of the application) comprises two separated basic stages, i.e. the search and substantive examination. *Art. 17*  
*Art. 18*

### 2. Objective of the search

The objective of the search is to discover the state of the art which is relevant for the purpose of determining whether, and if so to what extent, the claimed invention for which protection is sought is new and involves an inventive step. *Rule 61(1)*

The search is thus not usually directed to discovering disclosures which may be of interest to the applicant. However, under certain circumstances documents not directly relevant for assessing the patentability of the claimed invention may be cited in the search report (see B-X, 9.2.2 and 9.2.5).

The examination procedure and the preparation of the search opinion depend on the search for the knowledge of the state of the art on which assessment of the patentability of the invention is based. The search must, therefore, be as complete and effective as possible, within the limitations necessarily imposed by issues such as unity of invention and other considerations (see B-III, 2, B-VII and B-VIII).

### 3. Search documentation

The search is carried out in in-house or external collections of documents or databases, the contents of which are systematically accessible, e.g. by means of words, classification symbols or indexing codes. These are primarily patent documents of various countries, supplemented by a number of articles from periodicals and other non-patent literature (see B-IX).

### 4. Search report

A search report is prepared containing the results of the search, in particular by identifying the documents constituting the relevant state of the art (see B-X, 9). *Art. 92*  
*Rule 61(1)*

The search report serves to provide information on the relevant state of the art to the applicant, to the Examining Divisions of the EPO and, by means of its publication, to the public. *Art. 92*  
*Art. 93(1)*

The search report is accompanied by the search opinion (see B-XI, subject to the exceptions mentioned in B-XI, 7), which together with the European search report constitutes the Extended European Search Report (EESR).

#### 4.1 European searches

*Art. 17*

The task of the Search Division is primarily to carry out searches and draw up search reports in relation to European patent applications. In addition to these usual searches, the Search Divisions of the EPO may be called upon to perform various other types of searches, which are listed in the following paragraphs.

#### 4.2 Additional European searches

At the examination stage of a European patent application an additional search may be necessary. The reasons for such an additional search may be, for example:

- (i) amendment of claims so that they embrace matter not covered by the original search (see, however, C-III, 3.1.1 and H-II, 7.1, for claims not searched because of lack of unity and H-II, 6.2, for amendments introducing subject-matter from the description resulting in claims defining subject-matter which is not linked by a single general inventive concept to the subject-matter originally searched);
- (ii) removal by amendment or rebuttal, during substantive examination, of the deficiencies which resulted in the issuance of an incomplete search or a declaration taking the place of a search report under Rule 63, or a declaration under Art. 17(2)(a) or (b) PCT (see B-VIII and C-IV, 7.2);
- (iii) reversal, by the Examining Division, of an opinion of the Search Division with respect to novelty or lack of inventive step (see B-III, 1.1) or on other issues (see B-III, 1.2), in particular lack of unity of invention (see B-VII), exclusions from the search (see B-III, 3.11 and B-VIII) or Rule 62a; and
- (iv) limitations or imperfections in the initial search.

*Rule 63*

*Art. 17(2) PCT*

*Rule 64*

*Rule 62a*

The Examining Division makes use of documents found in such an additional search, where they are considered relevant to the examination of the application. Where a new document is used in the examination procedure, a copy must be communicated to the applicant (Art. 113(1)).

In a similar way, an additional search may become necessary during examination of oppositions against a European patent (see D-VI, 5).

#### 4.3 Supplementary European searches

*Art. 153(2), (6) and (7)*

An international (PCT) application for which the EPO acts as designated Office or elected Office and which has been accorded an international date of filing is deemed to be a European patent application. Where an international (PCT) search report is already available, this will take the place of the European search report. The Search Division will draw up a supplementary European search report



or a declaration replacing it according to Rule 63 unless provided otherwise in decisions of the Administrative Council.

However, the Administrative Council decides under what conditions and to what extent the supplementary European search report is to be dispensed with (see OJ EPO 2012, 212 and 219).

*Art. 153(7)*

#### **4.3.1 Dispensing with the supplementary European search report**

According to decisions taken by the Administrative Council, no supplementary European search report is drawn up in respect of an international application for which:

- (i) the EPO was the International Searching Authority or the Supplementary International Searching Authority (OJ EPO 2009, 594; OJ EPO 2010, 316);
- (ii) the Swedish, Austrian or Spanish Patent Office was the International Searching Authority and where the international application was filed before 1 July 2005 (OJ EPO 1979, 248; OJ EPO 1995, 511; OJ EPO 2012, 212 and , 219).

#### **4.3.2 A supplementary European search report is required**

According to decisions taken by the Administrative Council, a supplementary European search report including a search opinion pursuant to Rule 62 is drawn up (and the search fees reduced in cases (i) to (iii)) in respect of an international application for which:

- (i) the patent office of the USA, Japan, China, Australia, Russia or Korea was the International Searching Authority (OJ EPO 2005, 548; OJ EPO 2012, 212 and , 219);
- (ii) the Swedish, Austrian or Spanish Patent Office was the International Searching Authority and where the international application was filed on or after 1 July 2005 and also where the International Searching Authority was the patent office of Finland and the international application was filed on or after 1 April 2005 or where the Nordic Patent Institute was the International Searching Authority (see OJ EPO 2005, 422);
- (iii) a supplementary international search report was drawn up by one of the European International Searching Authorities referred to in (ii) (OJ EPO 2010, 316; OJ EPO 2011, 616);
- (iv) an international search report was drawn up by an International Searching Authority other than one of those mentioned in points (i) to (iii) and other than the EPO.

For the applications mentioned under (i) to (iv), the supplementary European search is carried out in all the search documentation of the EPO. It is left to the Search Division's judgment whether a limitation

as to the search documents is chosen. No precise limits can at present be set to these supplementary European searches since the documentation and search practice of these International Searching Authorities have not been fully harmonised in respect of the EPO.

As a general rule, the EPO should avoid any superfluous work and duplication of work and should rely on the efficiency and quality of the international searches to the largest extent possible. The EPO as designated Office requests the International Searching Authority or the Supplementary International Searching Authority to supply, together with the international search report, copies of the documents cited therein (Art. 20(3) PCT, see also Rule 44.3(a) PCT or Rule 45bis.7(c) PCT). When documents are cited that are not in one of the official languages of the EPO and the Search Division needs a translation into one of these languages, it should provide this itself (e.g. a patent family member in an official language of the EPO or, alternatively, an abstract of the document in an official language of the EPO, see B-VI, 6.2), unless it is able to obtain it from any other source, e.g. the applicant or the International Searching Authority.

The Search Division should consider the opinions on patentability expressed by the ISA, SISA and/or IPEA, whether contained (implicitly) in the search report or (explicitly) in the written opinion accompanying the search report. The Search Division is nevertheless free to deviate from any or all of these opinions when performing a supplementary European search and when preparing the search opinion.

#### **4.3.3 Application documents for the supplementary European search report**

*Rule 159(1)(b)*  
*Rule 161*

The European grant procedure, including the supplementary European search, is to be based on the application documents as specified by the applicant when the application enters the European phase (Rule 159(1)(b)). Alternatively, if, within a non-extendable period of six months as from notification of a communication pursuant to Rule 161(2) (see E-VIII, 3), the applicant has amended the application, the application as amended serves as the basis for the supplementary European search (see also B-XI, 2). For procedures relating to Euro-PCT applications where no supplementary European search report is prepared by the EPO, see E-VIII, 3.2, 3.3 and 3.4.

#### **4.4 International (PCT) searches**

For the search practice as regards international (PCT) searches, reference is made to the PCT International Search and Preliminary Examination Guidelines, as well as to the latest version of the Guide for applicants: "How to get a European patent, Part 2: PCT procedure before the EPO - Euro-PCT Guide".

#### **4.5 International-type searches**

Under the PCT, the EPO, as an International Searching Authority, may be entrusted to carry out "international-type searches" for national patent applications (Art. 15(5) PCT). These searches are by definition similar to international searches, and the same considerations apply, except where unity of invention is lacking; in case of a lack of unity in a national application subject to an international-type search, no reasoned statement on the lack of unity is included in the search report. Furthermore, no invitation to pay additional fees is issued, but applicants may have the possibility to pay these fees directly to the national offices. In cases where a written opinion is established, it is drafted in accordance with EPO practice under PCT Chapter I, including a reasoned statement in respect of any potential lack-of-unity objection.

#### **4.6 Searches on national applications**

The Search Divisions of the EPO also carry out searches on national applications of certain of its Contracting States. These guidelines are not necessarily fully applicable to these national searches, nor are the ways in which these searches differ from European searches specifically pointed out. However, these national searches are to a large extent identical to, or compatible with, European searches.

*Prot. Centr. I(1)(b)*



## Chapter III – Characteristics of the search

### 1. Opinions of the Search Division

#### 1.1 Opinions in relation to the search report

As stated in B-II, 2, the objective of the search is to discover the relevant state of the art for the purpose of assessing novelty and inventive step. Decisions on novelty and inventive step are the province of the Examining Divisions. However, in the search opinion (if applicable, see B-XI, 7), the Search Division gives the applicant a reasoned opinion on whether the application and the invention to which it relates meet the requirements of the EPC, to which he can reply in the examination procedure (Art. 113(1) and B-XI, 8). Opinions on patentability are also implicitly expressed in the search report by the assignment of document categories as defined in B-X, 9.2, and are subject to review by the Examining Division at the examination stage (see B-II, 4.2(iii) and B-XI, 1.2), in particular in the light of the applicant's reply thereto (see B-XI, 8).

*Rule 61(1)*

The assessment of patentability at the search stage can have a direct bearing on the execution of the search itself, see: B-III, 3.8 (search for subject-matter of dependent claims), B-III, 2.3 (search in analogous technical fields) and B-IV, 2.6 (stopping the search when only trivial matter remains).

#### 1.2 Opinions on matters relating to the limitation of the search

Occasionally matters of substantive examination other than novelty or inventive step have a direct bearing on the execution of the search and may result in a limitation thereof; here again these opinions are subject to review by the Examining Division (see T 178/84 and T 631/97, and B-II, 4.2(iii) and B-XI, 1.2), in particular in the light of the applicant's reply to the search opinion (see B-XI, 8).

Examples are to be found in B-VII (Unity of invention) and B-VIII (Subject-matter to be excluded from the search).

### 2. Scope of the search

#### 2.1 Completeness of the search

The European search is essentially a thorough, high-quality, all-embracing search. Nevertheless, it must be realised that in a search of this kind, 100% completeness cannot always be obtained, because of such factors as the inevitable imperfections of any information retrieval system and its implementation. The search should be carried out in such a manner as to reduce to a minimum the possibility of failing to discover complete anticipations for any claims, or other highly relevant prior art. For less relevant prior art, which often exists with a fair amount of redundancy amongst the documents in the search collection, a lower recall ratio can be

accepted (see in this context, however, B-III, 2.3). For limitations of the subject-matter searched by the EPO, see B-VIII.

The scope of the international search is defined in Art. 15(4) PCT stipulating that the International Searching Authority must endeavour to discover as much of the relevant prior art as its facilities permit and must, in any case, consult the documentation specified in the PCT Regulations (Rule 34 PCT). It follows from this definition ("as its facilities permit") that the scope of an international search shall be equivalent to a European search. International and European searches shall thus be fully compatible. In accordance therewith, if the EPO carried out the international search or the supplementary international search, no supplementary European search report need be drawn up and the international search report made by the EPO takes unconditionally the place of the European search report (Art. 153(6) EPC, see OJ EPO 2010, 316, and OJ EPO 2011, 616; see also B-II, 4.3).

## **2.2 Effectiveness and efficiency of the search**

The effectiveness and efficiency of any search for relevant documents (Rule 61(1)) depend on the degree of order which is available in, or which can be applied to, the collection of documents to be searched, the order allowing the examiner to determine sections of the documentation to be consulted. The basic components for creating order in a collection of documents are words, classification units, indexing codes or bibliographical links between documents by commonly cited documents. The order may have a permanent character, as with indexing words, classification symbols or indexing codes, or it may be created on demand by a search strategy judiciously using the above-mentioned basic components, the outcome of which is a section of the documentation which is likely to contain material pertinent to the invention. The examiner should for reasons of economy exercise his judgment, based on his knowledge of the technology in question and of the available information retrieval systems, to omit sections of the documentation in which the likelihood of finding any documents relevant to the search is negligible, for example documents falling within a period preceding the time when the area of technology in question began to develop. Similarly he need only consult one member of a patent family unless he has good reason to suppose that, in a particular case, there are relevant substantial differences in the content of different members of the same family (see B-IX, 2.4).

## **2.3 Search in analogous fields**

The search is carried out in collections of documents or databases which may contain material in all those technical fields pertinent to the invention. The search strategy should determine the sections of the documentation to be consulted covering all directly relevant technical fields, and may then have to be extended to sections of the documentation covering analogous fields, but the need for this must be judged by the examiner in each individual case, taking into

account the outcome of the search in the sections of the documentation initially consulted (see B-III, 3.2).

The question of which technical fields are, in any given case, to be regarded as analogous has to be considered in the light of what appears to be the essential technical contribution of the invention and not only the specific functions expressly indicated in the application.

The decision to extend the search to fields not mentioned in the application must be left to the judgment of the examiner, who should not put himself in the place of the inventor and try to imagine all the kinds of applications of the invention possible. The overriding principle in determining the extension of the search in analogous fields should be whether it is probable that a reasonable objection of lack of inventive step could be established on the basis of what is likely to be found by the search in these fields (see T 176/84, T 195/84 and G-VII, 3).

#### **2.4 Search on the internet**

The European search can also cover internet sources, including online technical journals, online databases or other websites (see OJ EPO 2009, 456). The extent of such internet searches depends on the individual case, but in some technical fields a systematic internet search will regularly be necessary. Especially in fields related to information or software technology, searches bypassing the internet will often not yield the most relevant prior art. Examiners may therefore use the internet as necessary also when searching unpublished applications but must take great care not to disclose confidential information through the inadvertent use of search terms. It is left to the individual examiner to select keywords that enable such a search to be performed while respecting the duty of confidentiality regarding unpublished applications. This would entail, for example, choosing only a few keywords which do not disclose the invention, rather than entering long portions of the text of a claim as a search term.

Concerning the dating of internet citations, see G-IV, 7.5.

### **3. The subject of the search**

#### **3.1 Basis for the search**

The search should be made on the basis of the claims, with due regard to the description and drawings (if any), (Art. 92). The claims determine the extent of the protection which will be conferred by the European patent if granted (Art. 69(1)).

*Art. 92*  
*Art. 69(1)*  
*Rule 43(6)*

#### **3.2 Interpretation of claims**

The search should on the one hand not be restricted to the literal wording of the claims, but on the other hand should not be broadened to include everything that might be derived by a person skilled in the art from a consideration of the description and drawings. The

*Prot. Art. 69*  
*Art. 92(1)*

examiner may need to consider the contents of the description and/or drawings when performing the search in order to:

- (i) identify the technical problem and its solution;
- (ii) establish definitions of unclear terms not defined in the claims;
- (iii) establish definitions of clear terms given a definition different from their usual meaning;
- (iv) ascertain the existence of a fallback position.

The objective of the search is to identify prior art which is relevant to novelty and/or inventive step (see B-II, 2). The search should be directed to what appear to be the essential features of the invention and take into account any changes in the (objective) technical problem underlying the invention which may occur during the search as a result of the retrieved prior art (see B-IV, 2.3 and 2.4, and G-VII, 5.2).

When interpreting claims for the purpose of the search, the search will also take into consideration prior art incorporating technical features which are well known equivalents to the technical features of the claimed invention, which may undermine inventive step (see G-VII, Annex, 1.1(ii)).

### **3.2.1 Claims with explicit references to the description or drawings**

Although explicit references in the claims to features elucidated in the description or in the drawings are only permissible where "absolutely necessary" (Rule 43(6) – see also B-III, 3.5, and F-IV, 4.17), claims containing such references should still be searched if these technical features are unambiguously defined by specific parts of the description.

However, where the reference does not clearly identify which subject-matter of the description and/or drawings is to be considered as included in the claim, an invitation under Rule 63(1) should be issued. In the special case of "omnibus claims" (e.g. a claim reading "The invention substantially as herein described"), no invitation under Rule 63(1) should be issued, and subsequently the search report will be designated as complete. This means that subject-matter of the above kind will be dealt with only during examination.

The procedure above should be followed regardless of whether or not the reference to the drawings and/or the description is allowable according to Rule 43(6). In either case, the claim will have the same scope: if the reference is not allowable under Rule 43(6), the applicant will be requested to copy the definition of the technical feature from the description and/or drawings into the claim; if the reference is allowable, the claim will stay as it is.



However, where the reference does not appear to be justified, the examiner should then raise an objection according to Rule 43(6) in the search opinion (if applicable - see B-XI, 7).

### **3.3 Amended claims or missing parts (Rule 56)**

#### **3.3.1 General considerations**

Where a European application does not derive from an earlier international application, the applicant may not amend the claims before receiving the European search report (Rule 137(1)). Consequently, in these cases, the search is directed to the claims as originally filed, in the European application, or to the set of claims filed according to Rule 57(c) or 58.

*Rule 56*  
*Rule 137(1)*

If the application documents used for the search contain missing parts of description and/or missing drawings filed under Rule 56(3) (see H-IV, 2.3.2) and the examiner expects the application to be re-dated by the Examining Division at a later stage of the procedure (see C-III, 1), he should extend the scope of the search, such as also to cover prior art which will be relevant for assessing the novelty and inventive step of the subject-matter claimed on the basis of a possible new date of filing of the application (see also B-XI, 2.1). The same applies to Euro-PCT applications when the application contains missing parts of the description, drawings or claims and/or missing elements filed under Rule 20.6 PCT.

#### **3.3.2 Specific rules applicable to Euro-PCT applications**

Where a European application derives from an earlier international application, the applicant may have amended the international application in the international phase, either after receipt of the international search report (Art. 19(1) PCT) or during international preliminary examination (Art. 34(2)(b) PCT). The applicant may then specify that he wishes to enter the European phase with these or otherwise amended application documents (including claims) according to Rule 159(1)(b). Furthermore, the applicant is given the opportunity by the EPO to amend the application documents (including the claims) within a set time limit (Rule 161(2), see E-VIII, 3). The application as amended serves as the basis for any supplementary European search which has to be performed pursuant to Art. 153(7) (see B-II, 4.3 and B-XI, 2).

*Rule 159(1)(b)*  
*Rule 161*

Where the claims of an international application on entry into the European (regional) phase are amended in such a way as to contravene Art. 123(2), the procedure explained in B-VIII, 6, applies.

#### **3.4 Abandonment of claims**

For European applications, claims that are deemed to have been abandoned for non-payment of fees must be excluded from the search. The claims which have actually been taken into account for the purposes of the search are identified in the search report. This applies both to searches to be carried out in respect of directly-filed

*Rule 45(3)*  
*Rule 162(4)*

European applications and to supplementary European searches to be carried out in respect of Euro-PCT applications entering the European phase (see B-II, 4.3).

### 3.5 Anticipation of amendments to claims

In principle, and insofar as possible and reasonable, the search should cover the entire subject-matter to which the claims are directed or to which they might reasonably be expected to be directed after they have been amended (see, however, B-VII, 1.3, in case of lack of unity).

#### *Example*

Where an application relating to an electric circuit contains one or more claims only directed to the function and manner of operation, and the description and drawings include an example with a detailed non-trivial transistor circuit, the search should include this circuit.

### 3.6 Broad claims

No special search effort need be made for searching unduly wide or speculative claims, beyond the extent to which they relate to matter which is sufficiently disclosed in the application (Art. 83), and are supported by the description (Art. 84).

#### *Example 1*

If the claims in an application relating to and describing in detail an automatic telephone exchange are directed to an automatic communication switching centre, the search should not be extended to automatic telegraph exchanges, data switching centres etc. merely because of the broad wording of the claim, but only if it is probable that such an extended search could produce a document on the basis of which a reasonable objection as regards lack of novelty or inventive step could be established.

#### *Example 2*

If a claim is directed to a process for manufacturing an "impedance element" but the description and drawings relate only to the manufacture of a resistor element, and give no indication as to how other types of impedance element could be manufactured by the process of the invention, extension of the search to embrace, say, manufacture of capacitors would not normally be justified.

#### *Example 3*

If the main claim relates to the chemical treatment of a substrate, whereas it appears from the description or all the examples that the problem to be solved is solely dependent on the nature of natural leather, it is clear that the search should not be extended to the fields of plastics, fabrics or glass.

Art. 83

Art. 84

#### *Example 4*

If the description and drawings are directed to a lock with a safety cylinder whereas the claims refer to a device allowing the indexation of the angular position of a first element with respect to two other rotating elements, then the search should be limited to locks.

In exceptional cases where the lack of disclosure or support is such as to render a meaningful search over the whole of the scope of the claim(s) impossible, application of the procedure for an incomplete search or a declaration taking the place of a search report under Rule 63 may be appropriate (see B-VIII, 3).

### **3.7 Independent and dependent claims**

The search carried out in sections of the documentation to be consulted for the independent claim(s) must include all dependent claims (for cases not complying with Rule 43(2), see B-VIII, 4). Dependent claims should be interpreted as being restricted by all features of the claim(s) upon which they depend. Therefore, where the subject-matter of an independent claim is novel, that of its dependent claims will also be novel (see, however, F-VI, 2.4.3). When the patentability of the subject-matter of the independent claim is not questioned as a result of the search, there is no need to make a further search or cite documents in respect of the subject-matter of the dependent claims as such (see, however, B-II, 4.2(iii) and B-XI, 1.2).

*Rule 43(4)*

#### *Example 1*

In an application relating to cathode ray oscilloscope tubes, in which the independent claim is directed to specific means along the edge of the front of the tube for illuminating the screen and a dependent claim is directed to a specific connection between the front and the main part of the tube, the examiner should, in the sections of the documentation he consults for searching the illumination means, also search for the connecting means whether in combination with the illumination means or not. If, after this search, the patentability of the illuminating means is not questioned, the examiner should not extend his search for the connecting means to further sections of the documentation which are likely to contain material pertinent to or specifically provided for these connections.

#### *Example 2*

If in an application dealing with a pharmaceutical composition for treating nail infections the patentability of the subject-matter of the independent claim relating to specific combinations of the active ingredients is not questioned as a result of the search, there is no need to continue the search for dependent claims dealing with the use of a specific volatile organic solvent as a carrier in the composition.

### 3.8 Search on dependent claims

However, where the patentability of the subject-matter of the independent claim is questioned, it may be necessary for assessing whether the subject-matter of the dependent claim as such is novel and involves an inventive step to continue the search in other sections of the documentation, e.g. in one or more additional classification units. No such special search should be made for features that seem *prima facie* trivial or are generally known in the art. However, if a handbook or other document showing that a feature is generally known can be found rapidly, it should be cited (see G-VII, 6(iii)). When the dependent claim adds a further feature (rather than providing more detail of an element figuring already in the independent claim), the dependent claim is to be considered in combination with the features in the independent claim and should be dealt with accordingly (see F-IV, 3.4).

### 3.9 Combination of elements in a claim

For claims characterised by a combination of elements (e.g. A, B and C) the search should be directed towards the combination. However, when searching sections of the documentation for this purpose, sub-combinations, including the elements individually (e.g. A and B, A and C, B and C, and also A, B and C separately) should be searched in those sections at the same time. A search in additional sections of the documentation either for sub-combinations or for individual elements of the combination should only be performed if this is still necessary for establishing the novelty of the element in order to assess the inventive step of the combination.

### 3.10 Different categories

When the application contains claims of different categories, all these must be included in the search (for cases not complying with Rule 43(2), see B-VIII, 4). However, if a product claim clearly seems to be both new and non-obvious, the examiner should make no special effort to search claims for a process which inevitably results in the manufacture of that product or for use of the product (see F-IV, 3.8 and G-VII, 13). When the application contains only claims of one category, it may be desirable to include other categories in the search. For example, generally, i.e. except when the application contains indications to the contrary, one may assume that in a claim directed to a chemical process, the starting products form part of the state of the art and need not be searched; the intermediate products are only searched when they form the subject of one or more claims; but the final products will always have to be searched, except when they are evidently known.

### 3.11 Subject-matter excluded from search

The examiner may exclude certain subject-matter from his search. These exclusions may result from certain subject-matter not complying with the provisions of the EPC relating to exclusions from patentability or to susceptibility to industrial application (see B-VIII, 1 and 2). They may also arise where the application does not comply

Rule 63

Rule 62a

with the provisions of the EPC to such an extent that a meaningful search is impossible for some or all of the claims, or for a part of a claim, for other reasons (see B-VIII, 3) or where the application does not comply with Rule 43(2) (see B-VIII, 4).

### **3.12 Lack of unity**

Also, when the claims of the application do not relate to one invention only, nor to a group of inventions linked so as to form a single general inventive concept, the search will normally be restricted to the invention or the linked group of inventions first mentioned in the claims (see B-VII). Restriction of the search for the above reasons will be notified to the applicant in a communication accompanying the partial search report (see B-VII, 1.2).

*Rule 64*

### **3.13 Technological background**

In certain circumstances it may be desirable to extend the subject-matter of the search to include the "technological background" of the invention. This would include:

- the preamble to the first claim, i.e. the part preceding the expression "characterised by" or "characterised in that";
- the state of the art which in the introduction of the description of the application is said to be known, but not identified by specific citations;
- the general technological background of the invention (often called "general state of the art").



## Chapter IV – Search procedure and strategy

### 1. Procedure prior to searching

Upon creation of a European search report, a European search opinion or a clarification request under Rule 62a and/or 63(1), a pre-search algorithm generating a list of documents to be inspected by the examiner is triggered. This creates a marker which serves as evidence in the file that the Search Division has started the search. The date of the start of the search is relevant for a possible refund of the search fee in case the application is withdrawn, refused or deemed to be withdrawn (see A-X, 10.2.1).

#### 1.1 Analysis of the application

When taking up an application to be searched, the examiner should first consider the application in order to determine the subject of the claimed invention taking account of the guidance given in B-III, 3. For this purpose he should make a critical analysis of the claims in the light of the description and drawings. He should in particular consider the content of the claims, description and drawings sufficiently to identify the problem underlying the invention, the inventive concept leading to its solution, the features essential to the solution as found in the claims and the results and effects obtained (see, however, B-III, 3.5). Furthermore, where technical features which are not present in the claims are indicated in the description as essential for the solution of the stated problem, these features should be included in the search (see F-IV, 4.3(ii) and T 32/82).

#### 1.2 Formal deficiencies

The search is carried out in parallel with the formalities examination. If the examiner notices any formal shortcomings which have been overlooked by the Receiving Section, he calls these, by means of an internal communication, to the attention of the Receiving Section (or of the Examining Division in the case of an additional search requested by that Division) which takes appropriate action. However, the examiner should not repeat the tasks of the Receiving Section and should not undertake any time-consuming enquiries into these matters. Such deficiencies which the examiner might notice include:

*Art. 90(1)*  
*Art. 92*  
*Art. 78*  
*Art. 53(a)*  
*Rules 30 to 34, 40 to 50 and 55 to 58*

(i) physical deficiencies of the application (see A-III, 3.2), including:

*Art. 90(3)*  
*Rule 57*

(a) no electronic sequence listing (Rule 30(1), OJ EPO 2011, 372);

(b) incorrect sequence and/or positioning of page numbering and/or failure to use Arabic numerals in page numbering (Rule 49(6));

(c) presence of drawings in the description and/or claims (Rule 49(9));

(d) presence of erasures and/or alterations in the application documents, such that the authenticity of the content and/or the requirements for good reproduction are jeopardised (Rule 49(12));

Art. 53(a)  
Rule 48(1)(a) and (b)

(ii) presence of prohibited matter in the application:

(a) which is contrary to "*ordre public*" (see A-III, 8.1, F-II, 7.2 and G-II, 4.1, 4.1.1 and 4.1.2); or

(b) constituting disparaging statements (see A-III, 8.2). Note, however, that fair comment as referred to in F-II, 7.3 is permitted;

Rules 31 to 33

(iii) failure to comply with the provisions relating to the deposition of biological material (see A-IV, 4), in particular with regard to the correct identification in the application of the depositary institution and accession number of the biological material assigned to the deposited material by the depositary institution (Rule 31(1)(c), see G 2/93 and A-IV, 4.2).

(iv) failure to correctly identify the application as a divisional application within the meaning of Art. 76(1) (see A-IV, 1.3.2, Rule 41(2)(e)).

(v) presence of text in two different EPO official languages (Art. 14).

### 1.3 Documents cited or supplied by the applicant

Rule 66  
Rule 141

Under the utilisation scheme (see Rule 141(1) and B-XI, 9, as well as OJ EPO 2010, 410), for applications where a priority is claimed the applicant is expected to file a copy of the results of any search carried out by the office of first filing (for more details see A-III, 6.12)

If the prior art information of the office of first filing is made available before the search is completed, the examiner should check these citations and evaluate their relevance to examination and in the definition of the search strategy.

Documents cited in the application under consideration should be examined if they are cited as the starting point of the invention, as showing the state of the art, or as giving alternative solutions to the problem concerned, or when they are necessary for a correct understanding of the application (see, however, B-IV, 2.4). However, when such citations clearly relate only to details not directly relevant to the claimed invention, they may be disregarded. In the exceptional case that the application cites a document that is not published or otherwise not accessible to the Search Division and the document appears essential to a correct understanding of the invention to the extent that a meaningful search would not be possible without knowledge of the content of that document, the Search Division should



apply the procedure under Rule 63 and invite the applicant to either submit the document or indicate the subject-matter to be searched (see B-VIII, 3). The invitation should contain the following information:

- (i) which cited document is needed;
- (ii) why the document is needed;
- (iii) the consequences of not supplying the document in time (see below).

If no copy of the document is received within the time limit according to Rule 63(1) and the applicant is unable to convince the Search Division in a timely response to the Rule 63(1) invitation that the document is not essential to facilitate a meaningful search, an incomplete search report or, where applicable, a declaration replacing the search report under Rule 63 is prepared (see B-VIII, 3.2.1). This incomplete search report or declaration will be issued giving the following grounds:

- (i) the non-availability of the document rendered the invention insufficiently disclosed within the meaning of Art. 83; and
- (ii) the insufficient disclosure mentioned in (i) existed to such a degree that a meaningful search was not possible on at least part of the claimed invention (see B-VIII, 3).

It should also be noted that where the applicant furnishes the document after the search report and the search opinion (if applicable, see B-XI, 7) have been prepared, an additional search on that subject-matter originally excluded from the search may be carried out due to the correction of the deficiency which led to the incomplete search (see C-IV, 7.2). However, applicants must be aware that such later furnished information can only be taken into account for sufficiency of disclosure pursuant to Art. 83 under certain circumstances (see F-III, 8).

## **2. Search strategy**

### **2.1 Subject of the search; restrictions**

Having determined the subject of the invention as outlined in B-IV, 1.1, it may be desirable for the examiner to prepare first a search statement, defining the subject of his search as precisely as possible. In many instances one or more of the claims may themselves serve this purpose, but they may have to be generalised in order to cover all aspects and embodiments of the invention. At this time, the considerations relating to subjects excluded from patentability (see B-VIII, 1 and 2) and to lack of unity of invention (see B-VII, 1.1) should be borne in mind. The examiner may also have to restrict the search because claims are deemed abandoned (see B-III, 3.4), because the requirements of the EPC are not met to

*Rule 63*  
*Rule 62a*

such an extent that a meaningful search is impossible (see B-VIII, 3) or because the application does not comply with Rule 43(2) (see the procedure defined in B-VIII, 4). Any such restrictions to the search must be indicated in the search report or declaration taking the place of the search report under Rule 63. The declaration should indicate the reasons for any restrictions under Rule 63 (see B-X, 8(iii)). The declaration or the incomplete search report is considered, for the purposes of subsequent proceedings, as the search report.

## **2.2 Formulating a search strategy**

Next the examiner should start the search process by formulating a search strategy, i.e. a plan consisting of a series of search statements expressing the subject of the search, resulting in sections of the documentation to be consulted for the search. In its initial phase, a search strategy will contain one or more combinations of the basic components mentioned in B-III, 2.2. The search process should be interactive and iterative in the sense that the examiner should reformulate his initial search statement(s) according to the usefulness of the information retrieved (see B-III, 1.1, and B-IV, 2.4 and 2.6). When using classification groups, the examiner should select the classification groups to be consulted for the search, both in all directly relevant fields and in analogous fields.

The examiner should consider, when appropriate, also consulting other classification (e.g. FI) or indexing (e.g. F-terms) schemes. Consultation of colleagues in a similar technical field or in fields possibly related to the content of the application should also be considered (see B-I, 2.1).

When in doubt about the appropriate fields in which to conduct the search, the examiner may request advice from the appropriate classification expert.

Usually various search strategies are possible, and the examiner should exercise his judgement, based on his experience and knowledge of the available search tools, to select the search strategy most appropriate to the case in hand. He should give precedence to search strategies yielding sections of the documentation in which the probability of finding relevant documents is highest. Usually the main technical field of the application will be given precedence, starting with the basic components (see B-III, 2.2) most relevant to the specific example(s) and preferred embodiments of the claimed invention. In considering whether to extend the search to other less relevant sections of the documentation, the examiner should always take account of the search results already obtained.

## **2.3 Carrying out the search; types of documents**

The examiner should then carry out the search, directing his attention to documents relevant for novelty and inventive step.

He should also note any documents that may be of importance for other reasons, such as:

- (i) conflicting documents (see B-VI, 4) which are:
  - (a) published European applications under Art. 54(3) (see G-IV, 5.1 and 5.1.1);
  - (b) published international applications under Art. 54(3) and Art. 153(3) and (5) (see G-IV, 5.2);
  - (c) published national applications of EPC Contracting States under Art. 139(2) (see G-IV, 6 and H-III, 4.5);
  - (d) any document published during the priority interval of the application which may be relevant under Art. 54(2) in case of a non-valid priority date.

When published within the priority interval of the application under search, these applications are cited in the search report as "P" documents (see B-X, 9.2.4); when published after the European or international filing date, they are cited in the search report as "E" documents (see B-X, 9.2.6);

- (ii) documents putting doubt upon the validity of any priority claimed (see B-VI, 3 and F-VI, 1.4.1), which are cited in the search report as "L" documents (see B-X, 9.2.8(a));
- (iii) documents contributing to a better or more correct understanding of the claimed invention, which are cited in the search report as "T" documents (see B-X, 9.2.5);
- (iv) documents illustrating the technological background, which are cited in the search report as "A" documents (see B-X, 9.2.2);
- (v) European patent applications having the same filing or priority date as the application in respect of which the search is carried out, from the same applicant and relating to the same invention and therefore relevant to the issue of double patenting (see G-IV, 5.4), which are cited in the search report as "L" documents (see B-X, 9.2.8 (c));
- (vi) documents indicating or establishing the publication date of a document drawn from the internet (see G-IV, 7.5), which are cited in the search report as "L" documents (see B-X, 9.2.8 (b)); and
- (vii) documents retrieved from the internet which do not have any publication date but which the examiner nonetheless wants to cite to inform the applicant or third parties (see G-IV, 7.5.4), which are also cited as "L" documents (see B-X, 9.2.8).

However, he should not spend a significant amount of time in searching for these documents, nor in the consideration of such matters unless there is a special reason for doing so in a particular case (see B-VI, 5.3 and B-XI, 4).

#### **2.4 Reformulation of the subject of the search**

The examiner should continuously evaluate the results of his search, and if necessary reformulate the subject of the search accordingly. For example, the selection of the classification units to be searched or the order of searching them may also require alteration during the search as a consequence of intermediate results obtained. The examiner should also use his judgement, taking into account results obtained, in deciding at any time during the systematic search whether he should approach the search documentation in some different manner, e.g. by consulting:

- (i) documents cited in relevant documents produced by the search, for example cited in the description or search report of a patent document; or
- (ii) documents citing a relevant document produced by the search,

or whether he should turn to documentation outside that which is available to the Search Divisions in-house (see B-IX). When searching external document collections for material in relation to unpublished subject-matter using other than secure connections, like the Internet, the examiner should be extremely careful when formulating search strategies so as not to unwittingly reveal confidential material – i.e. any part of the unpublished patent application (see B-III, 2.4).

#### **2.5 Closest prior art and its effects on the search**

It may happen that the examiner does not find any documents published before the earliest priority date which prejudice the novelty or the inventive step of the claimed invention. In such cases, the examiner should, whenever possible, cite in the search report at least that prior art found in the course of search which discloses a solution to the same problem as that underlying the claimed invention (wherein this problem may change depending on the prior art retrieved (G-VII, 5.2) and wherein the known solution is technically the closest to the claimed solution ("closest prior art"). Such prior art is to be cited as an "A" document in the search report (see B-X, 9.2.2).

If such a document cannot be found, the examiner should cite as the closest prior art a document which solves a problem closely related to the problem underlying the claimed invention and wherein the solution is technically most similar to that of the application under search.

Where the examiner retrieves documents which are incidentally prejudicial to the novelty of the claimed invention (to be cited as "X") but which do not affect the inventive step thereof after appropriate amendment of the application, and does not retrieve any other documents prejudicing inventive step, the examiner should also proceed as above.

In the case of a European application derived from an international application and being subjected to a supplementary European search after entering the European phase (Art. 153(7) – see B-II, 4.3), it is possible that the examiner does not uncover any further relevant prior-art documents in the search over and above the documents already cited in the international search report by the International Searching Authority. In such cases, it is permissible to have no further relevant documents in the supplementary European search report (see B-X, 9.1.4).

## **2.6 End of search**

Reasons of efficiency dictate that the examiner use his judgement to end his search when the probability of discovering further relevant prior art becomes very low in relation to the effort needed. The search may also be stopped when documents have been found clearly demonstrating lack of novelty in the entire subject-matter of the claimed invention and its elaborations in the description, apart from features which are trivial or common general knowledge in the field under examination, application of which features would not involve inventive step. The search for conflicting applications should, however, always be completed to the extent that these are present in the available documentation.

## **3. Procedure after searching**

### **3.1 Preparation of the search report**

After completion of the search, the examiner should select from the documents retrieved the ones to be cited in the report. These should always include the most relevant documents (which will be specially characterised in the report, see B-X, 9.2.1). Less relevant documents should only be cited when they concern aspects or details of the claimed invention not found in the documents already selected for citation. In cases of doubt or borderline cases in relation to novelty or inventive step, the examiner should cite rather more readily in order to give the Examining Division the opportunity to consider the matter more fully (see B-III, 1.1).

The examiner should not cite more documents than is necessary and therefore, when there are several documents of equal relevance, the search report should not normally cite more than one of them. In any case, the search report is accompanied by an annex drawn up by computer and listing the patent documents which are available and belong to the same patent family. In selecting from these documents for citation, the examiner should pay regard to language convenience,

and preferably cite (or at least note) documents in the language of the application (see B-X, 9.1.2).

### **3.2 Documents discovered after completion of the search**

It may happen occasionally that, after completion of a search report, the Search Division discovers further relevant documents (e.g. in a later search for a related application). Such documents may be used in examination (see C-IV, 7.4).

### **3.3 Errors in the search report**

When a material error is found to be present in a search report prior to publication thereof, a new search report will be drawn up which supersedes the preceding one. Where the search report has already been sent to the applicant according to Rule 65, but has not yet been published, the error should immediately be notified to the applicant. When a serious error is noted following publication of the search report, a corrigendum is published in the European Patent Bulletin, and the applicant and the Examining Division should be informed accordingly. If the error comprises the transmission of an incorrect document as a citation, the correct document should be sent.

## **Chapter V – Preclassification (routing) and official classification of European patent applications**

### **1. Definitions**

By "preclassification" is meant a first stage of routing, for purposes of internal handling, whereby the subject of the claimed invention (or the invention first claimed, if there is more than one) is broadly identified by means of the appropriate classification symbols. By "official classification" is meant the assigning of the appropriate classification symbols identifying the technical subject of the claimed invention (or of the subjects of each of the claimed inventions, if there is more than one), such identification being as precise and comprehensive as the classification permits. In addition, non-obligatory classification or indexation symbols may be attributed to any additional information contained in the document to be classified, which should be identified according to the Guide to the International Patent Classification ("IPC") published by WIPO (see also the WIPO website). The official classification of the European patent application is performed by the examiner, using the classification symbols contained in the rules of the IPC for the inventions as claimed ("Obligatory Classification"). He can also assign appropriate classification symbols and/or indexing codes to any additional information ("Non-Obligatory Classification") as defined in the Guide to the IPC in force at the time.

### **2. Preclassification (routing and distribution)**

In order for an application to be allocated correctly, a preclassification must be made. The level of classification at this stage should be as general as practicable on the basis of a quick and cursory scrutiny of the document (e.g. the title and independent claim or claims). On the other hand, the level should be specific enough to avoid the need for any intermediate stage of preclassification before allocation. This classification should be indicated by the use of the appropriate symbols in a space to be provided on the dossier and on the electronic interface.

In most cases no further classification is required to enable applications to be distributed to the relevant Search Divisions. However, where necessary, it falls within the authority of the examiner in charge of the field to arrange for such redistribution in an expedient manner.

### **3. Incorrect preclassification**

If, on reaching the Search Division, an application has been found to be incorrectly preclassified and thus inappropriately distributed, it is redistributed by the Search Division receiving it, indicating the appropriate amendments on the dossier and in the electronic tool. Normally this is done by mutual agreement with the Search Division to which it is proposed to redistribute it. However, cases arise over

which there is disagreement or uncertainty regarding classification boundaries, or where the Search Division dealing with the case is uncertain as to its correct preclassification. In such instances the Search Division having the case should not spend time in trying to resolve the matter, but should consult the specialists in the Classification Directorate.

#### **4. Official classification of the application**

The official classification of the European patent application is performed by the examiner as described above in B-V, 1. Preferably, this should be done when he has studied the content of the application in order to carry out the search. However, if publication of the application is due before the search report is drawn up, it is necessary for the examiner to study the application sufficiently to determine the official classification at this earlier stage (see B-X, 5).

If the official classification of the application is in more than one sub-class, or more than one main ("00") group within a sub-class, then all such classifications should be assigned. The classification of the invention as claimed should be distinguished from any additional classification and/or indexing code. In addition, where it is necessary to assign more than one symbol for the invention itself, the symbol which in the examiner's opinion most adequately identifies it, or, when this presents difficulties, the symbol which identifies the invention for which most information is given, should be indicated first, e.g. in order to facilitate subsequent allocation of the applications.

The classification should be determined without taking into consideration the probable content of the application after any amendment, since this classification should relate to the disclosure in the published application, i.e. the application as filed. If, however, the examiner's understanding of the invention, or of the content of the application as filed, alters significantly as a result of the search (e.g. as a result of prior art found or because of clarification of apparent obscurities), he should amend the classification accordingly, if the preparations for publication have not at that stage been completed.

#### **5. Classification of late-published search reports**

Where the search report is not available in time for publication of the application, and is therefore published separately, and the examiner finds it necessary to amend the original classification for the reasons given in B-V, 4, last paragraph, he should state the amended classification on the search report, indicating that it constitutes the official classification in place of that published on the application (which thus becomes merely the "classification for publication"). Such amendment of the classification should not be made unless the examiner is quite certain that it is necessary.



Where a European patent application is classified and published without the European search report (A2 publication), the European search report is prepared and published separately after publication of the application (A3 publication). It may happen that the IPC is amended in the period between publication of the European application (A2 publication) and the separate publication of the search report (A3 publication). In this case, the examiner must use for the search report that version of the IPC which was in force when the application was published.

#### **6. Classification when the scope of the invention is not clear (e.g. a partial search)**

When the scope of the invention is not clear, the classification has to be based on what appears to be the invention insofar as this can be understood. It is then necessary to amend it if obscurities are removed by the search, as discussed in B-V, 4, last paragraph.

#### **7. Classification in cases of a lack of unity of invention**

Where objection of lack of unity of invention arises, all inventions must be classified, since all will be disclosed in the published application. Each invention claimed is to be classified as set out in paragraphs B-V, 4 to 6.

#### **8. Verification of official classification**

As a general rule, applications will not be systematically scrutinised after leaving the Search Division in order to verify the correctness of the official classification assigned by the examiner. The Office may, however, institute such sampling check procedures as are deemed necessary to ensure correctness and uniformity in the application of the IPC. It is, of course, for the director to arrange for such checks as he considers necessary, having regard to the experience of his examiners, before the applications leave his directorate.



## Chapter VI – The state of the art at the search stage

### 1. General

The general considerations relating to the state of the art and patentability, especially with regard to the determination of novelty and inventive step, are set out in G-IV.

### 2. State of the art – oral disclosure, etc.

According to Rule 33.1(a) and (b) PCT, oral disclosure, use, exhibition, etc. are recognised as prior art only when this is substantiated by a written disclosure. In contrast, according to Art. 54 EPC, a public oral description, use, etc. is considered as prior art. However, the examiner, in carrying out a European search, should cite an oral description, etc. as prior art only if he has available a written confirmation or is otherwise convinced that the facts can be proved. Such references to oral disclosure, prior public use, disclosure by sale, etc. are more usually brought up by opponents in opposition proceedings (see G-IV, 7.1 to 7.4).

### 3. Priority

If the claimed priority dates cannot be verified at this stage, uncertainty will exist as regards their validity and the search for conflicting applications should be extended so as to cover all published applications with an earliest claimed priority date up to the filing date (not the claimed priority date(s)) of the application under consideration (see B-IV, 2.3 and B-XI, 4).

### 4. Conflicting applications

#### 4.1 Potentially conflicting European and international applications

Generally, where the search is concluded less than eighteen months after the European or international filing date of the application (the filing date according to Art. 80 and not its claimed priority date(s)), it will not be possible at the time of the search to make a complete search for potentially conflicting European and international applications. This search therefore has to be completed at the examination stage by the Examining Division (see C-IV, 7.1).

*Art. 54(3)*

#### 4.2 National earlier rights

There may also be national applications of one or more States designated in the European application of which the dates of filing are prior to the filing or priority date of the European application, and which were published as national applications or patents on or after that date. Although such applications are not a bar to the grant of a European patent, but only a ground for revocation in the Contracting State(s) concerned, they may be of importance to the applicant (see H-III, 4.5). Therefore, any of these which are present in the documentation are noted and mentioned in the search report for

*Art. 139(2)*

information (see B-X, 9.2.6). However, no special search effort should be made for this purpose (see B-IV, 2.3).

## **5. Date of reference for documents cited in the search report; filing and priority date**

### **5.1 Verification of claimed priority date(s)**

Where the validity of the priority claim cannot be verified at the search stage (see B-XI, 4), the basic reference date for the search must be taken as the date of filing of the European application as accorded by the Receiving Section. (For the reference date for the search with respect to conflicting applications, see, however, B-VI, 3).

### **5.2 Intermediate documents**

The Search Division takes into account documents published between the earliest priority date and the filing date of the application under consideration, and these documents are identified as such in the search report (see B-X, 9.2.4). For identifying these documents when an application has more than one priority date, the oldest date is to be applied. When deciding which documents to select for citing in the search report, the examiner refers to these dates and should preferably choose any published before the date of priority. Thus, for example, where there are two documents, one published before the date of priority and the other after that date but before the date of filing, but otherwise equally relevant, he should choose the former (see B-IV, 3.1, 2nd paragraph).

### **5.3 Doubts as to the validity of the priority claim; extension of the search**

It is the responsibility of the Examining Division to check whether and to what extent the priority claim is justified. However, where intervening state of the art (see B-VI, 5.2) or potential state of the art according to Art. 54(3) is revealed in the search, the Search Division should, if possible, check the validity of the priority claim (see B-XI, 4, F-VI, 1.2 to 1.5 and 2). Furthermore, documents showing that a priority claim might not be justified (e.g. an earlier application or patent from the same applicant indicating that the application from which priority is claimed may not be the first application for the invention concerned) should be cited in the search report (see B-X, 9.2.8). However, no special search effort should normally be made for this purpose, except when there is a special reason to do so, e.g. when the priority application is a "continuation-in-part" of an earlier application from which no priority is claimed (see B-IV, 2.3 and F-VI, 2.4.4). Sometimes the fact that the country of residence of the applicant is different from the country of the priority application may also be an indication that it is not a first filing, justifying a certain extension of the search.

*Art. 80*

*Rule 40*

*Art. 90(3)*

*Art. 54(2)*

When the search is extended for this purpose, it should be directed to:

- (i) published patent documents filed earlier than the claimed priority date.

*Example 1* (assuming that the applicant is the same for all applications):

date:	application:	subject-matter:
01.03.98	GB1 filed	A
30.05.98	GB2 filed	A
30.05.99	EP1 filed	A
	(claiming priority of GB2)	
10.09.99	GB1 published	A

During the search for EP1, the examiner retrieved published application GB1. GB1 may prejudice the priority claim of EP1, since it was filed earlier than GB2. Published GB1 should, therefore, be cited in the search report as an "L" document according to B-X, 9.2.8(a); or

- (ii) published patent documents which claim priority from an application filed earlier than the priority date of the application being searched.

*Example 2* (assuming that the applicant is the same for all applications):

date:	application:	subject-matter:
01.03.98	GB1 filed	A
30.05.98	GB2 filed	A
01.03.99	US1 filed	A
	(claiming priority of GB1)	
30.05.99	EP1 filed	A
	(claiming priority of GB2)	
15.04.00	US1 published	A

The publication US1 was found during the search for EP1. GB1 may prejudice the priority of EP1, since it was filed earlier than GB2. US1, which claims GB1 as priority, should, therefore, be cited in the search report as an "L" document according to B-X, 9.2.8(a).

#### 5.4 Documents published after the filing date

The search does not normally take into consideration documents published after the filing date of the application. However, some extension is necessary for specific purposes, as is apparent from B-VI, 2 to 4, and 5.3.

Certain other situations may occur in which a document published after the filing date is relevant; examples are a later document containing the principle or theory underlying the invention, which may be useful for a better understanding of the invention, or a later document showing that the reasoning or the facts underlying the invention are incorrect (see Art. 84 and F-IV, 6.3). The search should not be extended for this purpose, but documents of this nature known to the examiner could be selected for citation in the report (see B-X, 9.2.5).

### **5.5 Non-prejudicial disclosures**

*Art. 55(1)(a) and (b)*  
*Rule 25*

Disclosures of the invention should not be taken into consideration if they occurred no earlier than six months preceding the filing date of the European patent application (see G 3/98 and G 2/99) and if they were due to an evident abuse in relation to the applicant or his legal predecessor, or due to display at an official, or officially recognised, international exhibition. The Search Division should, nevertheless, cite in the search report any documents it has reason to believe come within one of the categories mentioned in B-X, 9.2.8. In this case too the reference date for the search will be the filing date of the application (see B-VI, 5.1 and B-XI, 4). Since the matter of abuse will generally only be raised after transmission of the search report and search opinion (if applicable, see B-XI, 7), and disclosure at an exhibition involves the question of identity between the displayed and claimed invention, both matters are investigated by the Examining Division.

### **5.6 Matters of doubt in the state of the art**

Since decisions with respect to novelty are not the responsibility of the Search Divisions but of the Examining Divisions (see B-III, 1.1), the Search Divisions should not discard highly relevant documents because of doubt as regards for example the exact date of publication or public availability (e.g. standards or standard preparatory documents, see G-IV, 7.6), or the exact contents of an oral disclosure, exhibition, etc. to which such documents may refer. The Search Division should try to remove any doubt that may exist but should nevertheless always cite the documents concerned in the search report and also continue the search as though that document had not been found. Additional documents providing evidence in the matters in doubt may be cited (see B-X, 9.2.8). The search opinion should contain details explaining the issue.

Any indication in a document of the date of its publication should be accepted as correct unless sound reasons for contesting this are given, e.g. by the Search Division, showing earlier publication, or in examination proceedings by the applicant, showing later publication. If the indicated date of publication is insufficiently precise (e.g. because only a month or year is given) to establish whether publication was before the reference date for the search, the Search Division should endeavour to establish the exact date with sufficient precision for the purpose. A date of receipt at the EPO stamped on

the document, or a reference in another document, which must then be cited (see B-X, 9.2.8), may be of assistance in this respect. In the preparation of the search opinion and during substantive examination, the public availability of a document may be investigated (see C-IV, 1). Where, despite the endeavours of the Search Division, the date is not sufficiently precise to know whether or not the document was published before or after the priority or filing date, the examiner should cite the document as though it had been published on the earliest possible date. For instance, if only the month and year of publication are known, the examiner should cite it as being published on the first day of that month.

## **6. Contents of prior-art disclosures**

### **6.1 General remark**

As a general rule, the Search Division selects for citation only documents which are present in the search documentation or which it has access to in some other manner. In that way, no doubt exists about the contents of the documents cited, since the examiner generally has physically inspected each document cited.

### **6.2 Citation of documents corresponding to documents not available or not published in one of the official EPO languages**

Under certain circumstances a document whose contents have not been verified may be cited, provided there is justification for the assumption that there is identity of content with another document which the examiner has inspected; both documents should then be mentioned in the search report in the manner indicated at the end of B-X, 9.1.2. For example, instead of the document published before the filing date in a non-EPO language and selected for citation, the examiner may have inspected a corresponding document (e.g. another member of the same patent family, or a translation of an article) in an official EPO language and possibly published after the filing date. Also it may be assumed that, in the absence of explicit indications to the contrary, the contents of an abstract are contained in the original document. Further, it should be assumed that the contents of a report of an oral presentation are in agreement with that presentation.

Before citing documents in a language with which he is not familiar, the examiner should make sure that the document is relevant (e.g. through translation by a colleague, through a corresponding document or abstract in a familiar language, or through a drawing or chemical formula in the document or by consulting database indexes relating to the technical content of that document (see B-X, 9.1.3)).

### **6.3 Conflict between abstract and source document**

Where there is a problem with an abstract, either because it appears to conflict with the source document to which it relates or because it conflicts with other abstracts of the same source document, the examiner should proceed as follows:

- (i) where the source document is in an accessible language (in particular a language of an EPC contracting state) and either is directly available to the examiner or may be ordered, the examiner should cite the source document.
- (ii) where the document is in an inaccessible language (for example Russian, Japanese or Chinese) and/or is difficult to obtain, the examiner should cite the abstract. Where more than one abstract is available, the examiner should cite the abstract most relevant to the claimed invention, regardless of any conflicts between that abstract and other abstracts or the source document.

The source document will be present in the search report as the "&" document of the cited abstract. Where it is available but is in an inaccessible language such as Japanese, both the source document and the abstract will be printed and sent to the applicant and included in the file (see B-X, 9.1.2). The examiner should explain in the search opinion why he considers that there is a conflict.

Where an abstract conflicts with the source document to which it relates, to the extent that the abstract is incorrect it does not form part of the state of the art: the source document on which the abstract is based then forms the state of the art (T 77/87). However, for the purpose of the search report and opinion, an abstract is considered a true representation of the content of the original document, unless the disparity between the two is evident. Being provided with both the abstract and the source document, the applicant will be able to compare both disclosures and reach conclusions about the technical validity of the abstract. The opportunity to refute the above assumption remains available in examination (for example, by providing a translation of the original document).

### **6.4 Insufficient prior art disclosures**

In general the examiner should assume that any technical subject-matter present in a prior art document is sufficiently disclosed and consequently is part of the state of the art. Even in cases of doubt the document should be cited in the search report in the normal way and relied upon for an appropriate objection in the search opinion. Only in clear cases of insufficient disclosure (see G-IV, 2) should such a document be discarded.

### **6.5 Incorrect compound records in online databases**

If an examiner retrieves a compound when interrogating a database created by abstracting source documents (e.g. patents, journal



articles or books) and deriving the chemical compounds disclosed in those documents and, on reading the source document, is unable to locate the compound, this does not automatically mean that an error has been made and that the compound is not disclosed in the document. For example, disclosed compounds which are named but whose structures are not drawn are still part of the disclosure and will be abstracted. In addition, database providers use standard nomenclature in their database records, whereas authors of technical literature frequently do not. Consequently, the nomenclature used for the compound in the database record may not be the same as that used in the source document.

However, in certain cases the examiner is really unable to locate the compound in the source document, and this compound is relevant to the assessment of patentability. In such cases, the examiner may write to the database provider asking why the compound in question was abstracted from that document and where it is disclosed in it. If the reply from the database provider is not available when the search report is drafted, the document should be cited in the search report and used in the search opinion on the assumption that the compound is disclosed in the document. However, the examiner should also continue the search as though the compound did not exist.

#### **7. Internet disclosures - technical journals**

For some technical journals, the publisher's website displays the date(s) when publications occur electronically, in particular if these differ from the publication dates of paper publications (OJ EPO 2009, 456). A number of different situations may occur in the case of electronic publication, as described in G-IV, 7.5.3.1. In all these instances, the examiner should print out the journal web page where the (electronic and paper) publication and pre-publication date(s) of the article or issue are mentioned, which should then be cited in the search report as an "L" document. It is best to do so as soon as the evidence is found and not leave it until later, since the information may be moved or removed from the website in the time which elapses between search and substantive examination.



## Chapter VII – Unity of invention

### 1. General remarks

The requirement of unity of invention serves a regulatory function in the interest of an efficient procedure up to grant (T 110/82 and F-V, 8). It would be unfair to regard as having unity of invention those applications which, because of their heterogeneous content, entail a far greater than average expense to process, especially in respect of search, since this expense must partly be borne by the fees levied for other applications. A further aspect is the requirement for ready comprehensibility of the application's subject-matter, which may be impaired by heterogeneous subject-matter.

On the other hand, the general purpose of dealing with interconnected substantive issues within a single procedure would not be achieved if provisions relating to unity of invention were applied too strictly. For this reason, interconnected matter should not be split up needlessly (see F-V).

#### 1.1 Partial European search report

If the Search Division considers that the European application does not comply with the requirement of unity of invention (see F-V, 1), it must search it, and draw up the partial European search report under Rule 64(1), for those parts of the application which relate to the invention (or group of inventions forming unity) first mentioned in the claims (see F-V, 8.2). The partial European search report is supplemented with a specification of the separate inventions.

*Rule 64*

With regard to the search opinion in cases of a lack of unity of invention, see B-XI, 5.

When determining which invention is the invention or unitary group of inventions first mentioned in the claims, the examiner takes account of the content of the dependent claims, disregarding trivial claims relating exclusively to features that seem unimportant in the light of the invention or that are generally known in the technical field of the invention (see B-III, 3.8).

#### 1.2 Invitation to pay further search fees

The Search Division will inform the applicant of the lack of unity of invention in a communication accompanying the partial search report and indicate that a further search fee must be paid for each invention other than the one first mentioned in the claims, if the search is to cover these inventions as well. The payment of these fees must take place within a period of two months (Rule 64(1)). If the automatic debiting procedure is being used for the application, the applicant must inform the EPO within this period if he does not want all or any of the further inventions to be searched. Otherwise all the further search fees due will be debited automatically on the last day of the period. Searches relating to inventions for which further search fees

*Rule 64(1)*

*Point 6.1 AAD*

have been paid within the fixed period receive preferential treatment from the Search Division. The search report is to be drawn up for all those parts of the patent application which relate to inventions in respect of which search fees have been paid. The search report identifies the separate inventions and indicates the subject-matter and corresponding claims (or parts of claims – see Rule 44(2)) for which a search has been made.

### **1.3 Documents relevant only to other inventions**

Whilst documents relevant only to other inventions may be retrieved during the search on the invention first mentioned in the claims, these are not necessarily included in the partial European search report. Such documents must, however, be cited in the partial search report if they form the basis for a lack of unity *a posteriori* (see F-V, 7 and 9).

### **1.4 Assessment and possible review of the unity requirement**

At the search stage, the examiner dealing with the question of unity applies the same criteria as in substantive examination (see F-V). In particular, he should not raise an objection of lack of unity merely because the inventions claimed are classified in separate classification groups, or merely for the purpose of restricting the search to certain sections of the documentation, for example certain classification groups (but see B-V, 7).

The assessment of unity cannot be made once and for all. Normally, the examiner will develop a first view even before he carries out the search. This first assessment is necessarily made in a *prima facie* manner, on the basis of general knowledge and the statements of prior art contained in the application. During and after the search the assessment should be reconsidered in the light of the documents found. The beginning of substantive examination is a further procedural step where the previous findings on unity should be reconsidered. Even later in the proceedings the position adopted previously may be superseded in view of new facts and evidence.

As a general rule, a previous position on unity of invention should be maintained unless strong reasons exist which lead to a situation where the position must be changed. The final decision on the question of unity of invention is taken by the Examining Division or, ultimately, the competent Board of Appeal. Therefore, as a matter of principle, any previous finding on unity is open to review.

## **2. Procedures in cases of lack of unity**

### **2.1 Request for refund of further search fee(s)**

At the examination stage the applicant may contest the allegation of non-unity and request a refund of one or more of the further fee(s) paid. If the Examining Division finds this to be justified, the fee(s) in question will be refunded (see, however, B-XI, 1.2).

Rule 64(2)

Rule 164(5)

## 2.2 Complete search despite of lack of unity

Exceptionally, in cases of lack of unity, especially "*a posteriori*", the examiner is able to make a complete search and prepare a search opinion (where applicable - see B-XI, 7) for all inventions with negligible additional work and cost, in particular when the inventions are conceptually very close. In those cases, the search for the further invention(s) is completed together with that for the invention first mentioned in the claims. All results should then be included in a single search report, which raises the objection of lack of unity and identifies the different inventions. It further indicates that the Search Division did not invite the applicant to pay further search fee(s) because all claims could be searched without effort justifying such a fee. However, the search opinion (if applicable, see B-XI, 7) still raises the issue of unity of invention (see B-XI, 5).

## 2.3 Supplementary European search

When in a supplementary European search following an international (PCT) search a problem of unity of invention arises, a partial supplementary European search report is drawn up on the invention or group of inventions first mentioned in the claims serving as basis for the supplementary European search (Rule 164(1)(a)), independently of the findings of the International Searching Authority as regards unity of invention. Together with this partial search report, the applicant receives an invitation to pay further search fees for each invention other than the one first mentioned in the claims (Rule 164(1)(b)), i.e. the same procedure is followed as for the non-unity invitation for EP direct applications under Rule 64(1) (see B-VII, 1.2).

*Art. 153(7)*

*Rule 164(1)*

## 3. Lack of unity and Rule 62a or Rule 63

The procedures for dealing with cases which lack unity and where Rule 63 or Rule 62a applies are dealt with in B-VIII, 3.4 and 4.5 respectively.



## Chapter VIII – Subject-matter to be excluded from the search

### 1. General remarks

In relation to searches carried out for European patent applications, the subject-matter listed in Rule 39.1 PCT may be considered under the EPC either not to be susceptible of industrial application (Art. 57) or, to the extent to which the European patent application relates to that subject-matter as such, to be excluded from patentability under Art. 52(2) and (3), or to constitute an exception to patentability under Art. 53(b) and (c). The claims are not searched in as far as they relate to such subject-matter (for the procedure for limiting the search according to Rule 63 see B-VIII, 3.1 to 3.4). For the specific case of compositions for use in methods of treatment of the human or animal body by surgery or therapy, or diagnostic methods practised on the human or animal body, see B-VIII, 2.1, below.

*Art. 52(2) and (3)*

*Art. 53*

*Art. 57*

*Rule 63*

While a decision on these matters rests with the Examining Division, opinions on these matters are formed by the Search Division for the purpose of drafting the search opinion (if applicable, see B-XI, 7) and also in considering possible limitations of the search and therefore whether or not to apply the procedure provided for under Rule 63(1) (see B-VIII, 3.1 to 3.4). The Search Division has thus to consider the requirements for patentability other than novelty and inventive step, as set out in G-II and G-III.

*Art. 52*

The above-mentioned situations may also occur for only some of the claims or for part of a claim. In these cases, this will be indicated in the invitation according to Rule 63(1) and in any subsequent incomplete search report or the declaration taking the place of the search report under Rule 63(2).

*Rule 63*

### 2. Considerations relating to certain technical fields

#### 2.1 Methods for treatment of the human or animal body by surgery or therapy and diagnostic methods practised on the human or animal body

Even if a claim is drafted as a method of medical treatment (see G-II, 4.2) and is for this reason not directed to patentable subject-matter, a meaningful search may be possible if the determining technical feature is the effect of the substance, which can be searched, and as such the procedure under Rule 63 (see B-VIII, 3.1 to 3.4) would not be necessary. If, however, specific method features are present (e.g. combination of pharmaceutical with physical treatment), a meaningful search may not be possible. In cases of doubt the Search Division should issue an invitation under Rule 63(1) (see B-VIII, 3.1). However, regardless of whether such claims are searched or not, the applicant's attention should be drawn in the search opinion (if applicable, see B-XI, 7) to the fact that such subject-matter is excluded from patentability (see B-XI, 3).

## 2.2 Computer-implemented inventions and business methods

For claims directed to computer-implemented inventions and business methods, where the aspects lending technical character to that subject-matter are so well known that nobody could reasonably dispute their existence at the relevant date ("notorious knowledge" as defined in T 1411/08, reasons 4.1 and T 690/06, reasons 13), no documentary evidence as to the relevant state of the art is required in the search report. Such cases, however, are exceptional.

Such "notorious knowledge" is not to be confused with the skilled person's common general knowledge, which is something that generally can be reasonably questioned (T 1411/08, reasons 4.1; G-VII, 2 and 3.1).

For computer-implemented inventions and business methods, where all the aspects lending technical character to the subject-matter are notorious, a search report under Rule 61 may be issued which comprises either:

- (i) a document linking information technology (IT) to non-technical processes

In cases where there is no other potential technical contribution beyond the idea of using IT to carry out and/or automate non-technical tasks (for example, to achieve better business results), the search will be complete when evidence is cited that the underlying idea of making use of generally known IT means for carrying out a non-technical activity was known at the filing or priority date. This document should be labelled "L" and a comment should be added in the search report.

- (ii) no document

Given that non-technical subject-matter is not searched and that the provision of a specific prior art document as evidence may be considered unnecessary for notorious knowledge, the search report need not cite a document to provide documentary proof that such notorious technical aspects of claimed subject-matter were comprised in the state of the art at the relevant date. The search report contains a statement to that effect associated with the Notice from the European Patent Office dated 1 October 2007 concerning business methods (OJ EPO 2007, 592), cited as an "L" document (see B-X, 9.2.8(d)).

## 3. No meaningful search possible

*Rule 63*

In addition to the reasons discussed in B-VIII, 1, an invitation under Rule 63(1) and subsequent limitation of the search under Rule 63(2) may also result from the application not meeting the relevant requirements of the EPC to such an extent that a meaningful search of the claims, or of some of the claims, or of part of a claim, is





impossible. In such cases, the Search Division should apply the procedure under Rule 63 (see B-VIII, 3.1 to 3.4, and OJ EPO 2009, 533).

What is or is not "meaningful" is a question of fact for the Search Division to determine. Its finding may change in the light of any reply from the applicant to the invitation under Rule 63(1) (see B-VIII, 3.2). The exercise of the Search Division's discretion will depend upon the facts of the case. A restriction of the search must be carefully considered. There are clearly cases where a search is rendered de facto impossible by the failure to meet the prescribed requirements of the EPC. The word "meaningful" should be construed reasonably. It should not be construed in such a way that Rule 63 is invoked simply because a search is difficult.

As there is no legal provision providing that an applicant must formulate the application in such a way as to make an economical search possible, "reasons of economy" cannot be used as a reason, or part of a reason, for issuing an incomplete search report (see also T 1020/98).

A number of non-limiting examples will illustrate where Rule 63 may find application:

(i) claims lacking support; insufficient disclosure

One example would be the case of a broad or speculative claim supported by only a limited disclosure covering a small part of the scope of the claim. This could be the case if the broadness of the claim is such as to render a meaningful search over the whole of the claim impossible, and where a meaningful search could only be performed on the basis of the narrower, disclosed invention. This may mean a search of the specific examples. In such a case, it will often be de facto impossible to do a complete search of the whole of the claim at all, because of the broad drafting style. Accordingly, the procedure under Rule 63(1) may be applied (see B-VIII, 3.1 to 3.4). Here, the requirements underlying the application of Rule 63 would be those of sufficiency of disclosure and support set out in Art. 83 and 84 (see F-III, 1 and 2, and F-IV, 6). The examiner should however bear in mind that the requirements under Art. 83 and Art. 84 concerning sufficiency of disclosure and support should be seen in relation to the person skilled in the art.

(ii) claims lacking conciseness

An example would be where there are so many claims, or so many possibilities within a claim, that it becomes unduly burdensome to determine the matter for which protection is sought (however, for the case of multiple independent claims in

the same category see B-VIII, 4). A complete search (or any search at all) may de facto be impossible. Again, the application of Rule 63 and the issuing of a subsequent incomplete search report (according to the procedures defined in B-VIII, 3.1 to 3.3) or a declaration of no search may be appropriate, on the grounds that the lack of conciseness of the claim(s) is such as to render a meaningful search impossible (see Art. 84; F-IV, 5).

(iii) claims lacking clarity

An example would be where the applicant's choice of parameter to define his invention renders a meaningful comparison with the prior art impossible, perhaps because the prior art has not employed the same parameter, or has employed no parameter at all. In such a case, the parameter chosen by the applicant may lack clarity (see Art. 84; F-IV, 4.11). It may be that the lack of clarity of the parameter is such as to render a meaningful search of the claims or of a claim or of a part of a claim impossible, because the choice of parameter renders a sensible comparison of the claimed invention with the prior art impossible. If so, the application of Rule 63 and the issuing of a subsequent incomplete search report (or, in exceptional cases, no search at all) under Rule 63(2) (according to the procedures defined in B-VIII, 3.1 to 3.3) may be appropriate, the search possibly being restricted to the worked examples, as far as they can be understood, or to the way in which the desired parameter is obtained (any response from the applicant to the invitation under Rule 63(1) being taken into account in determining the subject-matter to be searched to the extent indicated in B-VIII, 3.2).

(iv) claims contravening Art. 76 or Art. 123(2)

Rule 63 may also find application with regard to claims containing added subject-matter in the following cases (see B-VIII, 6):

- claims in divisional applications contravening Art. 76;
- applications for which the claims were filed after the filing date and which contravene Art. 123(2); or
- Euro-PCT applications for which amended claims were filed as a basis for the supplementary European search and which contravene Art. 123(2).

These examples are not exhaustive (see also B-VIII, 6). The basic principle is that there should be clarity and openness both for the applicant and for third parties as to what has and what has not been searched.

The treatment of these Rule 63 cases in subsequent examination proceedings is dealt with in H-II, 5 and 6.1.

### **3.1 Invitation to indicate subject-matter for search**

If the EPO considers that the application does not comply with the EPC to such an extent that it is impossible to carry out a meaningful search into the state of the art on the basis of all or some of the subject-matter claimed (see B-VIII, 1, 2 and 3), it will invite the applicant to file, within a period of two months, a statement indicating the subject-matter to be searched. The invitation will also give the reasons behind this finding and may additionally indicate the claimed subject-matter on which the Search Division considers it feasible to base a meaningful search.

*Rule 63(1), (2)*

In the particular case of medical method claims, a complete search report is issued only when the claims can easily be reformulated to patentable subject-matter (see B-VIII, 2.1). Conversely, if an incomplete search report (or a declaration of no search) is envisaged, an invitation must be sent (e.g. in respect of the claims that cannot easily be reformulated).

### **3.2 Reply to the invitation under Rule 63(1)**

#### **3.2.1 Failure to reply in time or no reply**

If the applicant does not reply in time to the invitation under Rule 63(1), the Search Division will determine what to search. In this case a partial search report will be drawn up accordingly, or in exceptional cases a declaration replacing the search report. This limitation of the search has consequences in examination (see H-II, 5 and 6.1). A late-filed reply is included in the file for consideration by the examiner at the examination phase because it may be useful for reviewing the arguments given by the examiner for carrying out an incomplete search.

Given that the search report should be published together with the application, the two-month period prescribed under Rule 63 is not open to further processing, but it is possible to request re-establishment of rights (see OJ EPO 2009, 533).

#### **3.2.2 Reply in time**

If the applicant replies in time to the invitation under Rule 63(1), indicating the subject-matter to be searched, and if a meaningful search based on the subject-matter that he has indicated is deemed possible by the Search Division, a search will be conducted on that subject-matter.

*Rule 63(2)*

If the applicant replies to the invitation under Rule 63(1) but in his reply indicates subject-matter which it is still not possible to search in full, the Search Division will determine the subject-matter to search, but will do so in a way which is consistent with the applicant's

response, to the extent that this is possible, or in exceptional cases may determine that no meaningful search is possible at all.

Statements consisting of reworded claims filed in reply to a communication pursuant to Rule 63 are not considered as amended claims in view of Rule 137(1) but merely as explanations in respect of the set of originally filed claims. These claims will then be formally introduced in the proceedings upon receipt by the EPO of a statement to that effect filed by the applicant within the time limits under Rule 70(1) and (2). This confirmatory statement can be filed either together with the reply to the extended European search report (Rules 70a(1) and (2)), or, where applicable, when complying with the requirements under Rule 70(1) and (2). As far as possible the Search Division will draw up the search report in the light of these clarifications. Both the search report and the search opinion should clearly indicate what has been searched.

If the applicant replies in time to the invitation under Rule 63(1), he may, instead of indicating the subject-matter to be searched, simply argue why he believes that it is possible to carry out a meaningful search on all of the subject-matter claimed. If the Search Division is convinced by the applicant's argumentation, a full search report will be issued and the consequences of a limitation of the search which apply in examination will not ensue. If the Search Division is not convinced, or is only partially convinced, it will issue a partial search report and will determine which subject-matter to search or, in exceptional cases, will issue a declaration replacing the search report. The final responsibility as to whether an invitation under Rule 63 was appropriate lies with the Examining Division. An additional search may be necessary in examination after a declaration or a partial search report has been issued at the search stage following an invitation under Rule 63(1) (see C-IV, 7.2).

Furthermore, the applicant may, in reply to an invitation under Rule 63, file arguments against the findings in the invitation requesting as a main request that the claims as filed be completely searched and as an auxiliary request, in case the examiner is not convinced, indicate specific subject-matter to be searched (see also H-III, 3.2).

A telephone consultation may take place if the applicant phones the examiner to enquire about the course of action after an invitation under Rule 63 has been sent. The consultation should be limited to formal issues concerning the content of the invitation and the options available to the applicant. The examiner writes minutes of the telephone consultation. The time limit set with the invitation is still applicable for the applicant to file a written reply; the telephone consultation *per se* does not constitute a valid reply.

### **3.3 The content of the extended European search report (EESR)**

The two components of the EESR, the search report (or the declaration replacing it) and the search opinion, will indicate the reasons why it was not considered possible to conduct a meaningful search in respect of some or all of the claimed subject-matter according to Rule 63 and will indicate the subject-matter which was searched, if any, as determined according to the procedures given in B-VIII, 3.2. Furthermore, the search opinion will also invite the applicant to limit his claims to subject-matter which has been searched (in order to comply with Rule 63(3)). The documents cited in the search report and referred to in the search opinion will relate only to this subject-matter. In the event that the subject-matter subject to the search complies with the requirements of the EPC (in particular in that it is novel, inventive and industrially applicable, but also satisfies the other requirements of the EPC such as clarity under Art. 84), the search opinion will still be negative, because the claims do not comply with the requirements of the EPC in respect of their full scope.

Furthermore, if in response to the invitation under Rule 63(1) the applicant disputes the finding that a meaningful search is not possible (see B-VIII, 3.2), but the Search Division is not convinced by the applicant's argumentation, it will indicate why this is the case in the search opinion, as appropriate. If necessary, it can refer directly in the search opinion to the applicant's reply.

### **3.4 Applications to which Rule 63 applies which also lack unity**

Cases will arise where the application does not comply with the EPC to such an extent that it is impossible to carry out a meaningful search into the state of the art on the basis of some of the subject-matter claimed ( B-VIII, 1, 2 and 3) and where the application also lacks unity of invention according to Art. 82 and Rule 44. It may be appropriate to raise only the issue of unity of invention and send an invitation under Rule 64(1) (see B-VII, 1.1 and 1.2), for example where a large number of claims which results in a severe lack of conciseness is resolved by splitting up the claims into different inventions.

It may, however, be necessary to apply the procedures under both Rule 64(1) (invitation to pay additional search fees for inventions other than that first mentioned in the claims) and Rule 63(1). In this case, the EPO will first send the applicant an invitation according to Rule 63(1), requesting the applicant to indicate the subject-matter to be searched. In cases where the lack of unity is already apparent before any clarification is received from the applicant, this invitation would also identify the first invention mentioned in the claims and the claims which relate to this invention, either in full or in part, and would invite the applicant to clarify what to search in respect of this invention first mentioned in the claims.

After expiry of the time limit according to Rule 63(1), the subject-matter, if any, to be searched in respect of the first invention will be

determined according to the procedures specified in B-VIII, 3.2. A partial search report (or exceptionally a declaration replacing it) will then be prepared on the invention first mentioned in the claims. This will be sent to the applicant along with an invitation to pay additional search fees under Rule 64(1) in respect of the other inventions. Where appropriate, this invitation under Rule 64(1) may also include an invitation according to Rule 63(1), inviting the applicant to clarify the subject-matter to be searched in respect of any additional inventions for which the applicant subsequently pays additional search fees.

*Rule 164(1)*

For Euro-PCT supplementary European search reports, where these exceptional conditions apply, the procedure will be as above, with the exception that a Rule 164(1) invitation is sent instead of a Rule 64 invitation.

*Rule 164(2)*

Rule 63 also applies to searches performed under Rule 164(2) (see C-III, 2.3). As for EP direct cases, any Rule 63 objection relating to an invention for which a search fee is to be paid must be included in the invitation itself.

#### **4. More than one independent claim per category (Rule 62a)**

*Rule 62a(1)*

##### **4.1 Invitation to indicate which independent claim to search**

If the European Patent Office considers that the claims as filed do not comply with Rule 43(2) (see F-IV, 3.2), it may invite the applicant to indicate, within a period of two months, claims complying with Rule 43(2) on the basis of which the search is to be carried out. Along the lines of Rule 64, the examiner has the discretion either to send this invitation or to make a complete search for all claims, raising the objection under Rule 43(2) only in the written opinion.

##### **4.2 Reply to the invitation under Rule 62a(1)**

###### **4.2.1 Failure to reply in time**

If the applicant fails to provide the above indication in due time, the search will be carried out on the basis of the first claim in each category. In either case a search report will be drawn up accordingly. This limitation of the search has consequences in examination (see H-II, 5 and 6.1). As for the invitation under Rule 63 above, a late-filed reply is included in the file for consideration at the examination stage.

Since the search report should be available on publication of the application, Rule 62a prescribes a response period of two months and rules out further processing. However, a request for re-establishment of rights may be granted, provided the relevant conditions are met.

#### **4.2.2 Reply filed in time**

If the applicant replies to the invitation under Rule 62a(1), indicating an independent claim in a particular category which he wishes the EPO to search, the EPO will conduct the search based on this claim.

In reply to this invitation, the applicant may also indicate more than one independent claim in the same category for search, where these fall within the exceptions provided for in Rule 43(2) (see F-IV, 3.2). However, if the applicant does so, but the EPO finds that the claims indicated do not fall within the exceptions provided for in Rule 43(2), only the independent claim with the lowest number indicated by the applicant will be searched.

#### *Example*

If an application contains independent product claims 1, 10 and 15, an invitation under Rule 62a(1) is sent and the applicant contends in his reply that independent product claims 10 and 15 fall within the exceptions provided for in Rule 43(2) and indicates that these two claims are to be searched, but the Search Division does not agree, then only claim 10 will be searched.

Where the applicant attempts to file amendments, the procedure indicated in B-VIII, 3.2.2, should be followed.

In any timely response to the invitation under Rule 62a(1), the applicant may, instead of indicating the independent claim or claims to be searched, simply argue why he believes that the claims comply with Rule 43(2) (i.e. why the plurality of independent claims in the same category fall within one or more of the exceptions provided for in Rule 43(2)). If the Search Division is convinced by the applicant's argumentation, a search report will be issued on the basis of all the claims, and the consequences of a limitation of the search which apply in examination will not ensue. If the Search Division is not convinced, it will issue a search report for which the search will be conducted based on the first independent claim in that category. The final responsibility as to whether an invitation under Rule 62a was appropriate lies with the Examining Division.

Furthermore, the applicant may, in reply to an invitation under Rule 62a, file arguments against the findings in the invitation requesting as a main request that the claims as filed be completely searched and as an auxiliary request, in case the examiner is not convinced, indicate the independent claims to be searched (see also H-III, 3.2).

The applicant may phone the examiner in order to enquire about the course of action after an invitation under Rule 62a has been sent, as explained above for the invitation under Rule 63 (see B-VIII, 3.2.2).

### **4.3 The content of the extended European search report (EESR)**

The search opinion will invite the applicant to limit the application to claims which have been searched (Rule 62a(2)). Furthermore, if in response to the invitation under Rule 62a(1) the applicant disputes the finding under Rule 43(2) (see B-VIII, 4.2), but the Search Division is not convinced by the applicant's argumentation, it will indicate why this is the case in the search opinion, as appropriate.

### **4.4 Cases under Rule 62a where claims fees are not paid**

If an independent claim has been deemed to be abandoned under Rule 45(3) or Rule 162(4) as a result of the non-payment of claims fees (see A-III, 9), the applicant cannot indicate this claim for search in response to the invitation under Rule 62a(1), because no search is conducted on such a claim (see B-III, 3.4). The indication of such a claim by the applicant in response to the invitation under Rule 62a(1) will be ignored by the EPO, which will then apply Rule 62a(1), last sentence, and will search the first independent claim in the category in question for which claims fees **have** been paid.

If all independent claims in the category in question have been deemed to be abandoned for failure to pay claims fees, no invitation under Rule 62a(1) will be sent in respect of these claims and none of them will be subject to a search.

### **4.5 Applications to which Rule 62a applies which also lack unity**

Cases will arise where the application does not comply with Rule 43(2) (see B-VIII, 4.1 and F-IV, 3.2) and the application also lacks unity of invention according to Art. 82 and Rule 44. It may be appropriate to raise only the issue of unity of invention and send an invitation under Rule 64(1) (see B-VII, 1.1 and 1.2).

It may, however, be necessary to apply the procedures under both Rule 64(1) (invitation to pay additional search fees for inventions other than the first mentioned in the claims) and Rule 62a(1). In this case, the EPO will first send the applicant an invitation according to Rule 62a(1), requesting him to indicate the independent claims to be searched.

In cases where the lack of unity is already apparent when the invitation under Rule 62a(1) is sent, it will also identify the first invention mentioned in the claims and the claims which relate to this invention, either in full or in part, and will invite the applicant to indicate which claims to search in respect of this invention first mentioned in the claims. After expiry of the time limit according to Rule 62a(1), the claims to be searched in respect of the first invention will be determined according to the procedures specified in B-VIII, 4.2. A partial search report will then be prepared on the invention first mentioned in the claims. This will be sent to the applicant along with an invitation to pay additional search fees under



Rule 64(1) in respect of the other inventions. Where appropriate, this invitation under Rule 64(1) may also include an invitation according to Rule 62a(1), requesting the applicant to clarify the claims to be searched in respect of any additional inventions for which he subsequently pays additional search fees.

Conversely, it may also happen that after an invitation is sent according to Rule 62a(1) in respect of all claims, the claims which satisfy Rule 43(2) and which are subject to a search (as determined according to the procedures given in B-VIII, 4.2) are subject to an objection of lack of unity *a posteriori*. In such cases, an invitation to pay additional fees under Rule 64(1) will then be sent, the invitation being based only on the subject-matter of the claims determined by the applicant's response (or failure to respond) to the invitation under Rule 62a(1).

For Euro-PCT supplementary European search reports, where these exceptional conditions apply, the procedure will be as above, with the exception that a Rule 164(1) invitation is sent instead of a Rule 64 invitation.

*Rule 164(1)*

Rule 62a also applies to searches performed under Rule 164(2) (see C-III, 2.3). As for EP direct cases, any Rule 62a objection relating to an invention for which a search fee is to be paid must be included in the invitation itself.

*Rule 164(2)*

#### **4.6 Treatment of dependent claims under Rule 62a**

Claims depending either directly or indirectly via other dependent claims on an independent claim excluded from the search in accordance with Rule 62a(1) (see B-VIII, 4.2) are likewise excluded from the search. Conversely, if a dependent claim depends on more than one previous claim, not all of which were searched, that dependent claim will be searched only in as far as it depends on a claim or claims which were searched in accordance with Rule 62a(1).

#### **5. Invitation under both Rule 62a(1) and Rule 63(1)**

In certain cases it may be appropriate to send an invitation according to both Rule 63 (see B-VIII, 3.1) and Rule 62a(1) (see B-VIII, 4.1). This may be necessary, for example, in cases where clarifying which claim or claims to search under Rule 62a will not necessarily help to clarify what subject-matter to search because the application contains several independent claims in the same category, none or only some of which can be subject to a meaningful search in respect of their entire scope. In such cases invitations under both Rule 62a(1) and Rule 63(1) will be sent in a single communication. This single communication gives rise to the same two-month time limit for reply under both rules. In such cases, applicants wishing to respond to both invitations should do so simultaneously.

In response to this invitation under Rule 62a(1) and Rule 63(1), the applicant must not indicate independent claims (in response to the

invitation under Rule 62a(1)) and subject-matter (in response to the invitation under Rule 63(1)) which are inconsistent with each other. If the applicant provides inconsistent indications, the Search Division may, depending on the circumstances, either (i) elect to search the claims indicated by the applicant according to Rule 62a(1), where necessary limiting the subject-matter searched in respect of those claims according to Rule 63(2) *mutatis mutandis* or (ii) elect to search the subject-matter indicated by the applicant according to Rule 63(1) and as defined in the first independent claim of a particular category which is consistent with that subject-matter according to Rule 62a(1), last sentence, *mutatis mutandis*.

Although sent in the same communication, the invitations under Rule 62a(1) and Rule 63(1) are still legally separate. Consequently, the applicant may also reply to only one of the invitations and not to the other. If he replies only to the Rule 62a(1) invitation, option (i) of the previous paragraph applies. If he replies only to the Rule 63(1) invitation, option (ii) of the previous paragraph applies.

#### **6. Claims contravening Art. 123(2) or Art. 76(1)**

If the claims on which the search is to be based were filed after the date of filing or under Rule 58, they do not form part of the application documents "as originally filed". Also, for Euro-PCT applications (see B-III, 3.3.1), it may happen that amended claims form the basis for the supplementary European search. In either case, before starting the search, the examiner checks whether or not these claims introduce subject-matter that extends beyond the content of the application "as originally filed" (see also A-III, 15). For Euro-PCT applications, this is the PCT application as originally filed.

If the claims contravene the requirements of Art. 123(2), the examiner will face one of the following situations:

- (a) if there are doubts about the objection (e.g. the amendment relies on common general knowledge and the examiner is unsure if the introduced term can be based on this) and/or the amendment does not significantly change the scope and subject of the search: the examiner searches the claims as they are.
- (b) if there are certain individual features in the claims that clearly violate Art. 123(2): the examiner performs the search ignoring these features.
- (c) if there are substantial non-allowable amendments in the claims: the examiner may need to issue an invitation under Rule 63(1) prior to starting the search (see B-VIII, 3(iv)). Depending on the reply to the invitation, an incomplete search report or even a declaration replacing the search report according to Rule 63 may be issued. In deciding what to

Art. 123(2)  
Rule 58

include in the search and what to exclude from it, the examiner should refer to how the invention is defined in the description.

A similar problem may also occur when a divisional application is filed and the amended claims do not satisfy the requirements of Art. 76(1): the same criteria as described in steps (a) to (c) above should then be applied.

In any case, the search opinion will include an objection under Art. 123(2) or Art. 76(1) indicating the reasons for limiting the scope of the search.



## Chapter IX – Search documentation

### 1. General

#### 1.1 Organisation and composition of the documentation available to the Search Divisions

The basic part of the search documentation consists of a collection of patent documents systematically accessible in a manner suitable for searching. Additionally, periodicals and other publications of technical literature are put at the disposal of the examiners. This non-patent literature is accessible through in-house or external databases, some of which are arranged in the library in a manner suitable for consultation; parts thereof, such as particularly relevant articles, are selected and made available for direct access by incorporating these, or copies thereof, into the systematic documentation. The systematically accessible part of the search documentation includes the minimum documentation required for an International Searching Authority under Rules 34 and 36.1(ii) PCT and extends somewhat beyond these minimum requirements.

#### 1.2 Systematic access systems

All examiners have at their disposal computer facilities for searching the search documentation. These allow, amongst other things, the use of the Cooperative Patent Classification (CPC), which is based on the International Patent Classification (IPC) but comprises finer internal subdivisions. Searches can also be performed using other classification systems and/or words.

### 2. Patent documents arranged for systematic access

#### 2.1 PCT minimum documentation

The systematically accessible search documentation includes the national patent documents belonging to the PCT minimum documentation as specified in Rule 34.1(b)(i) and (c) PCT.

Also included are published international (PCT) and regional (e.g. European) patent applications, patents, and inventors' certificates (Rule 34.1(b)(ii) PCT).

A complete list of the contents of the PCT minimum documentation is available on the WIPO website.

#### 2.2 Unpublished patent applications

Since the completion of the search for conflicting applications that are not published at the time of the initial search is entrusted to the Examining Divisions, the documents which can be cited in the search report do not include unpublished patent applications (see B-VI, 4.1).

### **2.3 Search reports**

The official European and international (PCT) search reports are normally published together with the European and international applications and are included in the search files together with these applications. The official search reports relating to national applications, as well as unofficial search reports, are also included in these files to the extent that they are available to the public. Search reports that are not normally or not yet accessible to the public in the form of a published document are nevertheless available to the examiners separately from the state of the art documents, and searching thereof is not compulsory for all applications.

### **2.4 Patent family system**

The EPO keeps a patent family system based on application data and priority data of the patent documents stored in databases of the EPO. When viewing patent documents on screen, normally only one representative document of a patent family is displayed, but links to the other members of its patent family are provided.

## **3. Non-patent literature arranged for systematic access**

### **3.1 Periodicals, records, reports, books, etc.**

The systematically accessible search documentation includes the relevant articles from the list of periodicals belonging to the minimum documentation under the PCT as established by the competent WIPO body and from other periodicals where deemed useful by the examiners. In principle, copies of the articles selected as relevant for search purposes are added to the EPO search databases with a fictitious country code "XP", scanned for inclusion in the electronic "BNS" collection and included in the manual search files, where appropriate.

The EPO also subscribes to many further periodicals including abstract journals. Furthermore, records of conference proceedings, reports, books, standards, etc. covering the three official languages of the EPO and the various technically important geographical areas are obtained. Individual items are selected for inclusion in the online documentation insofar as they constitute useful additions to the state of the art.

## **4. Non-patent literature arranged for library-type access**

### **4.1 Composition**

In addition to the non-patent literature mainly serving search purposes (see B-IX, 3), the non-patent literature arranged for library type access also comprises such literature serving primarily as sources of information and education of the examiners both as regards general and background technical information and as regards new technical developments. Furthermore, the collection includes many reports, pamphlets, etc. internet-based document delivery services of publishing companies are made available to examiners in

the form of an Electronic Virtual Library (EVL), which can be used from the examiner's desktop computer.

#### **5. Access to EPO documentation for the national patent offices**

The EPO provides the national offices of its member states with access to its electronic search documentation as described in B-IX, 2.1 to 2.3.

For other documentation of the EPO, if delivered by commercial database providers, access can be limited, depending on the conditions of data delivery agreed between the EPO and the data provider. However, separate agreements may exist between national offices and data providers.





## Chapter X – Search report

### 1. General

The results of the search will be recorded in a search report. A number of different possible limitations of the scope of the search report exist. These are:

- (i) where claims are deemed abandoned for non-payment of claims fees (Rule 45(3), see B-III, 3.4);
- (ii) a declaration replacing the search report according to Rule 63 (see B-VIII);
- (iii) an incomplete search report according to Rule 63 and/or Rule 62a (see B-VIII);
- (iv) a partial European search report due to a finding of a lack of unity according to Rule 64(1); and
- (v) a supplementary European search report according to Art. 153(7) may be incomplete for the reasons given in (i) or (iii) or may be replaced by a declaration according to (ii) (in the case of unpaid claims fees for a supplementary European search, Rule 162(4) applies).

The search reports of types (i) - (iii), (and (v) (insofar as only (i) - (iii) apply) are transmitted to the applicant, published and serve as a basis for the examination by the Examining Division. A partial search report according to Rule 64(1) (case (iv) above), however, is only transmitted to the applicant, but is made available for inspection in the public part of the examination file according to Art. 128(4).

Subject to the exceptions mentioned in B-XI, 7, European search reports and supplementary European search reports are accompanied by a search opinion, where the Search Division gives an opinion on whether the application and the invention to which it relates seem to satisfy the requirements of the EPC (see B-XI, 1.1). Together, the European search report or supplementary European search report and the search opinion constitute the extended European search report (EESR).

*Rule 62(1)*

The Search Division is responsible for drawing up the European search report. It is also responsible for drafting international search reports and search reports on behalf of the industrial property offices of certain Contracting States (see B-X, 2 and B-II, 4.4 to 4.6).

This chapter contains the information which is necessary to enable the examiner to correctly prepare the search report.

A search report must contain no matter, in particular no expressions of opinion, reasoning, arguments or explanations, other than that required by the form or referred to in B-III, 1.1 and 1.2, or B-X, 9.2.8. However, this does not apply to the search opinion (see B-XI, 3).

## 2. Different types of search reports drawn up by the EPO

The EPO will draw up the following types of search reports:

- (i) European search reports (see B-II, 4.1);
- (ii) supplementary European search reports concerning PCT applications (see B-II, 4.3);
- (iii) "search results under Rule 164(2)" (see C-III, 2.3); |
- (iv) international search reports under the PCT (see B-II, 4.4); ══
- (v) international-type search reports (see B-II, 4.5); ══
- (vi) search reports drawn up on behalf of national offices (see B-II, 4.6); and ══
- (vii) search reports further to special work. ══

Further, in the examination procedure, accounts containing the results of additional searches are drawn up when necessary and are not published (see B-II, 4.2). However, the documents cited therein may be used in the examination procedure (see C-IV, 7.2).

This chapter sets out the requirements for search reports of types (i) to (v) only, although it is the intention that all search reports drawn up by the EPO are as similar as possible. ══

## 3. Form and language of the search report

### 3.1 Form

The standard search report is prepared by the examiner and contains a main page to be used for all searches for recording the important features of the search, such as:

- (i) the application number;
- (ii) the classification of the application;
- (iii) the fields searched;
- (iv) the relevant documents revealed by the search; and
- (v) the name of the examiner who executed the search,

as well as supplemental sheet A and, in certain cases, also supplemental sheet B.

Supplemental sheet A is to be used for indicating approval or modifications of the title, the abstract as submitted by the applicant, and the figure to be published with the abstract and for giving the translation of the title into the two other official languages (see B-X, 7).

Supplemental sheet B is to be completed where there are restrictions on the search, i.e. when claims incurring fees are not searched due to non-payment of claims fees (see B-III, 3.4), when unity of invention is lacking (see Chapter B-VII), when a meaningful search is not possible such that the search report is an incomplete one or is completely replaced by a declaration according to Rule 63 (see B-VIII, 3) or when the search is limited according to Rule 62a (see B-VIII, 4).

Dates appearing in the report should be expressed according to the WIPO standard ST.2.

### **3.2 Language**

The search report or the declaration accompanying or replacing it according to Rule 63 should be drawn up in the language of the proceedings.

*Art. 14(3)*  
*Rule 61(5)*

### **3.3 Account of the search**

For internal quality purposes, at the end of the search the examiner completes an account summarising all the information necessary for auditors to understand what has been searched (see B-III, 3), as well as where (see B-III, 2) and how (see B-IV, 2) the search was carried out. The account of the search is not public.

## **4. Identification of the patent application and type of search report**

On the main page and supplemental sheets, the European patent application is identified by its application number.

The type of the search report is indicated in the report.

In case of a joint publication of the application and the search report, the main page of the report is marked A1 (WIPO Standard ST.16). If publication of the application is due before the search, the main page is marked A2 (WIPO Standard ST.16). The subsequent search report is established on a new main page which is marked A3 (WIPO Standard ST.16). Where the search report is a supplementary European search report in respect of an international application, this search report is established on a new main page marked A4 (WIPO Standard ST.16).

*Art. 153(7)*

## 5. Classification of the patent application

The main page of the report gives the official classification symbol(s) for the European patent application in accordance with B-V, 4.

If the application is to be published before the search report is prepared (A2 publication, see B-X, 4), the examiner prepares supplemental sheet A before the publication of the application. In such cases, supplemental sheet A will contain all of the requisite information indicated in B-X, 7, and also the official classification of the application (in cases where the application lacks unity, see B-V, 7).

When subsequently the search report is established (A3 publication, see B-X, 4), the official classification of the application is repeated on the separately published search report. Where the examiner has modified the official classification (i.e. the official classification as given in the A2 published application differs from that given on the later published A3 search report – see B-V, 4), it is this amended classification which will appear on the later published A3 search report (see B-V, 5).

## 6. Areas of technology searched

Although the EPC does not require the European search report to identify the areas of technology searched, this information is included in the report in the form of a list of IPC symbols up to the sub-class level.

Where the search report is entirely or partly based on a previous search made for an application relating to a cognate subject, the sections of the documentation consulted for this previous search are also identified in the report as having been consulted for the application in question. This is done by indicating the appropriate IPC symbols.

## 7. Title, abstract and figure(s) to be published with the abstract (as indicated on supplemental sheet A)

Supplemental sheet A is prepared by the examiner before publication of the application, regardless of whether this is with the search report (A1 publication) or without it (A2 publication). The information contained in supplemental sheet A is needed for the publication of the application.

On supplemental sheet A, the examiner indicates:

- (i) approval or amendment of the text of the abstract, the content of which is communicated to the applicant according to Rule 66 (see A-III, 10). Examination of the abstract does not go beyond ensuring that it relates to the application concerned and that there is no conflict with the title of the invention or with the classification of the application. Since the abstract should relate to the application as filed, the examiner should consider it and

determine its definitive content before carrying out the search, in order to avoid being inadvertently influenced by the results of the search.

If the search report is published separately (A3 publication), information about the abstract is not given in the communication. The information sent to the applicant includes the title of the invention and the figure, if any, of the drawings to be published with the abstract.

In exceptional cases, the examiner may change the abstract after the search has been carried out. However, if this is done after the application has been published A2, supplemental sheet A is not reissued;

- (ii) approval or amendment of the title of the invention (see A-III, 7); *Rule 41(2)(b)*
- (iii) approval, modification or abolition of the selection of the figure which is to accompany the abstract (see F-II, 2.3(vi) and 2.4); and *Rule 47(4)*
- (iv) the translation of the title of the European application into the two other official languages. *Art. 14(7)(a)*

The European Patent Bulletin is published in all three official languages of the EPO according to Art. 14(7)(a) and contains the entries made in the Register of European Patents, which, according to Rule 143(1)(c), must contain the title of the invention. Consequently, the title is required in all three official languages of the EPC.

The above applies equally to applications published with the search report (A1 publication) and those published without it (A2 publication). In the case of an A2 publication, supplemental sheet A further contains the official classification of the application (see B-X, 5). In case of an A1 publication, the official classification appears only on the search report (Rule 61(6)).

Supplemental sheet A also indicates the nature of the publication to which it relates (A1 or A2).

In the case of a supplementary European search report in respect of an international application, supplemental sheet A should be marked A4. The examiner does not determine the title, abstract or figure to be published with the abstract, since these have already been determined by the International Searching Authority according to Rules 37.2, 38.2(a) and 8.2 PCT, respectively.

## 8. Restriction of the subject of the search

In the following cases, the search report, the declaration replacing it, or the incomplete or partial search report will indicate whether the subject of the search was restricted and which claims have or have not been searched:

- Rule 45(1) and (3)*  
*Rule 162(1) and (4)*
- (i) claims above the number of fifteen for which no additional fee has been paid (see B-III, 3.4). The claims not searched are identified. This only applies to European and supplementary European search reports;
- Rule 64(1)*
- (ii) lack of unity of invention (see B-VII). The different inventions must be mentioned by indicating their subject-matter and the claims relating thereto (in part or in full; see Rule 44(2)). For the partial search report (see B-VII, 1.1), an indication is made that it has been established for the invention first mentioned in the claims. This applies to *a priori* lack of unity and to *a posteriori* lack of unity. For the search report which will be drawn up for all those inventions in respect of which search fees have been paid, the different inventions (and corresponding claims in full or in part) which have been searched are indicated in the search report;
- Rule 63*  
*Art. 52(2)*  
*Art. 53*
- (iii) claims in respect of which a meaningful search cannot or only an incomplete search can be carried out (see B-VIII). A declaration is made either:
- (a) that a meaningful search has not been possible on the basis of all claims (this declaration replaces the search report); or
- (b) that a meaningful search has not been possible for one or more of the claims in part or in full. In this case, the claims concerned are mentioned in the declaration accompanying the incomplete search report.
- In both cases (a) and (b), the reasons for not carrying out or restricting the search should be indicated (for example: subject-matter not patentable; insufficiently clear claims);
- Rule 62a*
- (iv) claims in respect of which a search was not carried out due to non-compliance with Rule 43(2) (see B-VIII, 4.2).

## 9. Documents noted in the search

### 9.1 Identification of documents in the search report

#### 9.1.1 Bibliographic elements

All documents cited in the search report must be identified unambiguously by indicating the necessary bibliographic elements. All citations in the search report should comply with WIPO Standard

ST.14 (Recommendation for the inclusion of references cited in patent documents), WIPO Standard ST.3 (Two-letter codes) and ST.16 (Standard code for identification of different kinds of patent documents). This does not exclude deviations in those special cases where strict adherence, whilst not necessary for the clear and easy identification of a document, would require considerable extra cost and effort.

### 9.1.2 "Corresponding documents"

The examiner will often be confronted by the existence of "corresponding" documents (see B-VI, 6.2), that is to say documents which have the same or substantially the same technical content. These usually fall into one of two groups, namely patent documents from a patent family and abstracts:

(i) Patent documents in the same patent family

These are patent documents from the same country or from different countries, and which share at least one claimed priority.

If a cited patent document belongs to a patent family, the examiner need not cite all the members of the family which are known or accessible to him, since these are already mentioned in the annex to the search report. However, he may mention one or more members in addition to the one cited (see B-IV, 3.1). Such documents should be identified by the Office of origin, type and number of document, and preceded by the sign ampersand (&). There are a number of possible reasons why the examiner may wish to draw attention in the search report to more than one document in the same patent family, including the following:

- (a) One document of the patent family is published before the earliest priority date of the application, but is published in a non-EPO language, whereas a different member of the same patent family is published in an EPO language (see Art. 14(1)), but after the earliest priority date of the application.

#### *Example*

A European application claims a priority of 3 September 1999. In the search on this application, a relevant document – WO 99 12395 A – is found. This document is published in Japanese on 11 March 1999 – in time to constitute prior art according to Art. 54(2). There also exists the European family member published in an English translation according to Art. 153(4) on 1 March 2000 – too late to constitute prior art according to Art. 54(2), but cited in the search report as an "&"

document of the Japanese-language WO publication and sent to the applicant (see B-X, 11.3). It will be used in examination of the application to interpret the content of the Japanese language WO publication (see G-IV, 4). In the search report, these documents would be cited as follows (for the mentioning of the claims to which the cited documents relate, here claims 1-10, see B-X, 9.3):

X WO 99 12395 A (SEKI SHUNICHI; KIGUCHI HIROSHI (JP); SEIKO EPOSON CORP (JP)) 1-10  
 11 March 1999 (1999-03-11)  
 \* figure 1 \*  
 & EP 0 982 974 (SEIKO EPSON CORP)  
 1 March 2000 (2000-03-01)  
 \* figure 1 \*  
 \* claim 1 \*

- (b) Different documents in the same patent family each containing relevant technical subject-matter not present in the other family members;
- (c) Where a family member is cited in the application in a non-EPO language and there exists another family member in an EPO language, where these are both published before the earliest priority date.

*Example*

Y WO9001867 A (WIDEGREN LARS (SE)) 1-10  
 8 March 1990 (1990-03-08)  
 \* claim 1 \*

D,Y & SE461824 B (WIDEGREN LARS (SE)) 1-10  
 2 April 1990 (1990-04-02)

The fact that the applicant has already cited the relevant SE document in the application, which is a family member of the relevant WO document, means that the applicant has already satisfied the requirement that he mention in the description the state of the art (Rule 42(1)(b)). It is of value to the Examining Division that this be made known in the search report (see F-II, 4.3).

- (ii) Abstracts of documents (see B-VI, 6.2)

These are provided by one of a number of database providers (for example Chemical Abstracts or Derwent) and may relate to many different types of disclosure such as patent documents, journal articles, PhD theses, books etc. The abstract provides a summary of the most important aspects of the technical content of the original document. Most abstracts cited are in the



English language. In all cases where an abstract is cited in the search report, the examiner must input the original document to which the abstract relates after the "&" sign.

*Example*

X	DATABASE WPI	1-5
	Week 200961	
	Thomson Scientific, London, GB;	
	AN 2009-N01904	
	& WO 2009/104990 A1 (VALEXPHARM CO	
	LTD) 27 August 2009 (2009-08-27)	
	* abstract *	

The examiner may choose to cite the abstract (in which case the original document must be cited as an "&" document) rather than cite the original document for one of a number of reasons. These reasons include: the original document is not easily available to the examiner (for example, retrieval of PhD theses); or the original document is in a non-EPO language and no other corresponding document exists (for example, a journal article in Russian). The original document is sent to the applicant only if it is so designated by the examiner (see B-X, 12).

If the examiner wishes to refer to a Japanese or Korean published patent application (with kind code A), he should cite the Japanese or Korean publication in the search report. If there is an English abstract available in the EPO databases (Patent Abstracts of Japan or Patent Abstracts of Korea), both the Japanese or Korean publication and the English abstract are sent to the applicant.

### 9.1.3 Languages of the documents cited

Frequently, members of the same patent family are published in a number of different languages. Consequently, the examiner has a choice regarding the language of the document which is cited in the search report. If the relevant technical content does not differ between the various family members and they are all published before the earliest priority date of the application, then all of the members of the family are of equal relevance to the application. In such cases, the examiner should choose the document to be cited by virtue of its language of publication and according to the following list, the most preferred language being given first:

- (1) an official language of the EPO (i.e. English, French or German (Art. 14(1)));
- (2) an official language of a Contracting State of the EPC according to Art. 14(4) (see A-VII, 1.1). Such documents can

usually be read by a colleague if the examiner in question is not familiar with this language (see B-VI, 6.2);

- (3) a language other than any of those of the Contracting States of the EPC.

In the cases (2) and (3), the examiner might consider citing an abstract in an official language of the EPO, instead of the original document.

If the original document is in a less "accessible" language (e.g. Chinese or Russian), it is best to cite the abstract. In some cases it is possible to obtain an automated translation of certain patent documents into an official language of the EPO. If the examiner relies on this translation in the search opinion, he should send it to the applicant by annexing a copy of the automated translation to the search opinion (see B-X, 12, and G-IV, 4).

Alternatively, if only a specific paragraph of the translation is needed, the examiner may copy the translation of that paragraph into the search opinion instead of annexing the entire translation. Non-official translations (i.e. translations having no legal value) of publications in "less accessible" languages should not be cited in the search report.

#### **9.1.4 Supplementary European search report**

In the case of a supplementary European search report according to Art. 153(7), it is also permissible under certain circumstances to have no documents at all cited on the supplementary European search report (see B-IV, 2.5). In such cases, the expression "No further relevant documents disclosed" will appear in the search report. However, in such cases, the search opinion (if applicable, see B-XI, 7) will give an opinion on the patentability of the claimed invention over the state of the art cited in the International Search Report (B-XI, 1.1).

If the Search Division disagrees with the ISA opinion on the relevance of a document cited in the international search report to the novelty and/or inventive step of the claimed invention, the document in question should not be re-cited in the supplementary European search report with a new, corrected document category. The exception to this is where the examiner wishes to combine a first document found only in the supplementary European search as a "Y" category with a second document already cited in the international search report: in this case the examiner may re-cite the second document from the international search report in the supplementary European search report as a "Y" document in combination with the first document.

#### **9.2 Categories of documents (X, Y, P, A, D, etc.)**

All documents cited in the search report are identified by placing a particular letter in the first column of the citation sheets. Where

needed, combinations of different categories are possible. The following letters are used.

### 9.2.1 Particularly relevant documents

Where a document cited in the European search report is particularly relevant, it should be indicated by the letter "X" or "Y". Category "X" is applicable where a document is such that **when taken alone**, a claimed invention cannot be considered novel or cannot be considered to involve an inventive step.

*Art. 52(1)*

*Art. 54*

*Art. 56*

Category "Y" is applicable where a document is such that a claimed invention cannot be considered to involve an inventive step when the document is combined with one or more other documents of the same category, such combination being obvious to a person skilled in the art. However, if a document (a so-called "primary document") explicitly refers to another document as providing more detailed information on certain features (see G-IV, 5.1) and the combination of these documents is considered particularly relevant, the primary document should be indicated by the letter "X", i.e. not "Y", and the document referred to should be indicated as "X" or "L" as appropriate.

*Art. 52(1)*

*Art. 56*

### 9.2.2 Documents defining the state of the art and not prejudicing novelty or inventive step

Where a document cited in the European search report represents state of the art not prejudicial to the novelty or inventive step of the claimed invention, it should be indicated by the letter "A" (see, however, B-III, 1.1).

### 9.2.3 Documents which refer to a non-written disclosure

Where a document cited in the search report refers to a non-written disclosure, the letter "O" should be entered (see B-VI, 2). Examples of such disclosures include conference proceedings. In cases where the oral disclosure took place at an officially recognised exhibition (Art. 55(1)(b)), see B-VI, 5.5. The document category "O" is always accompanied by a symbol indicating the relevance of the document according to B-X, 9.2.1, or 9.2.2, for example: "O, X"; "O, Y"; or "O, A".

*Rule 61(4)*

### 9.2.4 Intermediate documents

Documents published on dates falling between the date of filing of the application being examined and the date of priority claimed, or the earliest priority if there is more than one (see B-VI, 5.2 and B-XI, 4), should be denoted by the letter "P". The letter "P" should also be given to a document published on the very day of the earliest date of priority of the patent application under consideration. The document category "P" is always accompanied by a symbol indicating the relevance of the document according to B-X, 9.2.1 or 9.2.2, for example: "P, X"; "P, Y"; or "P, A".

*Rule 61(3)*

### 9.2.5 Documents relating to the theory or principle underlying the invention

Where a document cited in the search report may be useful for a better understanding of the principle or theory underlying the invention, or is cited to show that the reasoning or the facts underlying the invention are incorrect, it should be indicated by the letter "T".

### 9.2.6 Potentially conflicting patent documents

*Art. 54(3)*  
*Art. 139(2)*

Any patent document bearing a filing or priority date earlier than the filing date of the application searched (not the priority date – see B-VI, 3 and B-XI, 4) but published later than that date and the content of which would constitute prior art relevant to novelty (Art. 54(1)) should be indicated by the letter "E". Where the patent document and the application searched have the same date (see G-IV, 5.4), the patent document should also be identified by the letter "E". An exception is made for patent documents based on the claimed priority under consideration; these documents should not be cited.

### 9.2.7 Documents cited in the application

*Rule 42(1)(b)*

When the search report cites documents already mentioned in the description of the patent application for which the search is carried out, these should be denoted by the letter "D" (see B-IV, 1.3).

### 9.2.8 Documents cited for other reasons

*Art. 117(1)(c)*

Where in the search report any document is cited for reasons (in particular as evidence – see B-VI, 5.6) other than those referred to in the foregoing paragraphs, for example:

- (a) a document which may throw doubt on a priority claim (see B-VI, 5.3);
- (b) a document which establishes the publication date of another citation (see B-VI, 5.6);
- (c) a document relevant to the issue of double patenting (see B-IV, 2.3(v), and G-IV, 5.4); or
- (d) a document setting out the EPO position on matter excluded from search, specifically for computer-implemented inventions and business methods (see B-VIII, 2.2),

such document should be indicated by the letter "L". Brief reasons for citing the document should be given. In the specific case where a search examiner considers no documentary evidence to be necessary for the claimed subject-matter, as it is deemed to be notorious (see B-VIII, 2.2) and cites a document according to paragraph (d) above, the reasoning behind not citing any prior art documents should be given in the search opinion.

The citation of "L" documents need not be linked to any of the claims. However, where the evidence which they provide relates only to certain claims (for example the "L" document cited in the search report may invalidate the priority claim in respect of certain claims only), then the citation of the document should be linked to those claims, in the manner indicated in B-X, 9.3.

### 9.3 Relationship between documents and claims

Each document cited in the search report should be accompanied by an indication of the claims to which it relates, unless the document is indicated by category letter "L" (see B-X, 9.2.8). One and the same document may be indicated by different categories with respect to different claims, wherein each category is associated with particular claims.

*Rule 61(2)*

#### *Example*

X	WO9001867 A (WIDEGREN LARS (SE)) 8 March 1990 (1990-03-08)	1
Y	* column 3, line 27 - line 43; figure 1 *	2-5
A	* figure 2 *	6-10

The above example means that the cited document discloses subject-matter which prejudices the novelty or inventive step of the subject-matter of claim 1 and the inventive step of the subject-matter of claims 2 to 5, when combined with another document cited in the search report, and that it represents non-prejudicial state of the art for the subject-matter of claims 6 to 10. The passages or figures are not necessarily relevant to the claims and the category indicated on the same line.

Furthermore, each independent claim should be mentioned in the search report at least once in relation to at least one document published before the earliest priority date (unless the independent claim in question is excluded from the search by virtue of a restriction of the subject of the search mentioned in B-X, 8) (see B-IV, 2.5).

### 9.4 Identification of relevant passages in prior art documents

In the case of long documents, the examiner should indicate those parts (such as a claim, example, figure, table or text passage on a particular page) of a cited document which contain the technical subject-matter closest to (or coinciding with) the searched invention. This is of particular importance where the document is relied upon for objections of novelty or inventive step.

*Rule 61(2)*

Furthermore, it makes sense to cite not only those parts of the document describing the same or similar technical subject-matter, but also those parts or passages relating to the problem solved by that subject-matter. This approach facilitates the assessment of inventive

step in examination and also gives the applicant a greater indication of how the document may be used during prosecution.

#### **10. Authentication and dates**

The date on which the search report was drawn up is indicated in the report. This date should be that of the drafting of the report by the examiner who carried out the search.

The name of the examiner must appear on the search report.

#### **11. Copies to be attached to the search report**

##### **11.1 General remarks**

The search report is sent to the applicant and transmitted to the Examining Division. In both cases, the report must be accompanied by copies of all documents cited (see also B-IV, 3.3), except those documents appearing in the search report after the "&" symbol, which are not designated for copying and communication to the applicant (see B-X, 11.3).

These cited documents are used to assess the patentability of the claimed invention (see B-XI, 3) both in the search opinion (if applicable, see B-XI, 7) and in the examination procedure.

##### **11.2 Electronic version of document cited**

In the case of a patent document, a complete copy is supplied even if the patent is bulky.

In cases where part or all of the document is published only by electronic means (see Rule 68(2) and OJ EPO 2000, 367), an electronic version of at least those parts of the document not available in paper form will be made available to the applicant. This must be done in such a way that the applicant is provided with the whole document either in a combination of paper and electronic forms or in electronic form only.

##### **11.3 Patent family members; the "&" sign**

In the case of patent families, only a copy of the member of the family actually cited is normally supplied. The other members are mentioned in an annex systematically produced by the computer for information only (see B-X, 9.1.2). However, in certain circumstances one or more further patent documents in the same patent family may be mentioned on the search report after the "&" sign (see B-X, 9.1.2(i)). In these cases, the examiner may designate that a patent document appearing after the "&" sign is also copied and forwarded to the applicant (this document will then also be included in the examination file and may be referred to in the search opinion, if applicable).

##### **11.4 Reviews or books**

In the case of a review or a book, copies should be made of the title page and the relevant pages of the publication concerned.

### **11.5 Summaries, extracts or abstracts**

Where a document cited is a summary, extract or abstract of another document, published separately, a copy of the summary, extract or abstract is forwarded to the applicant along with the report.

If, however, the Search Division considers that the entire document is required, that document must be cited and a copy must be attached to the report (see B-X, 9.1.2(ii)). In the case of a reference obtained by an online search for which neither the printed version from the database (e.g. COMPDX, PAPERCHEM2 and NTIS) nor the original article is available at the EPO at the time of drafting the search report, the print-out is added to the file in lieu of the original. This may also be done where the printed form of the abstract is available, but where there is no difference in the relevant technical content between the abstract derived from the database print-out and the printed version thereof.

### **11.6 Citation of video and/or audio media fragments available on the internet**

Video and/or audio media fragments available on the internet are converted into a non-patent literature citation and cited as a screen shot of the first page of the internet citation. The bibliographic data contain the URL of the original location on the internet. A copy of the video and/or audio media is made in the original format and stored on a server. Only if the applicant so requests will a DVD be created and dispatched to him.

### **12. Transmittal of the search report and search opinion**

The EPO forwards the search report, the search opinion (if applicable, see B-XI, 7) and copies of all cited documents to the applicant, see B-X, 11.1), including automated translations annexed to the ESOP (when appropriate, see B-X, 9.1.3) and those documents appearing after the "&" sign and designated to be copied and sent to the applicant (see B-X, 11.3).

*Rule 65*  
*Rule 61(1)*





## Chapter XI – The search opinion

### 1. Search opinion is part of the EESR

The extended European search report (EESR) is made up of two components: *Rule 62(1)*

- (i) the European search report or the supplementary European search report (see Chapter B-X)
- (ii) the search opinion

#### 1.1 The search opinion

For European applications filed as of 1 July 2005 and international applications filed as of that date entering the European phase, European search reports and supplementary European search reports will be accompanied by an opinion on whether the application and the invention to which it relates seem to meet the requirements of the EPC.

The above applies except in the cases referred to in B-XI, 7.

The findings of the search opinion must be consistent with the document categories assigned in the search report and must also be consistent with any other issues raised in the search report, such as lack of unity of invention or limitation of the search.

#### 1.2 Position of the Examining Division

The Examining Division will consider both the objections raised in the search opinion and the applicant's response thereto (see B-XI, 8) when examining the application further. It may change the position adopted in the search opinion after receiving arguments, amendments and other submissions from the applicant in response to the search opinion or subsequently in examination proceedings. The position may also alter, irrespective of the applicant's submissions, where the top-up search could not be completed when the search was performed and Art. 54(3) state of the art is found in a top-up search by the Examining Division or further state of the art is brought to the attention of the Examining Division by the applicant or by means of observations according to Art. 115 (see also B-IV, 3.2, C-IV, 7.2 and 7.3).

The Examining Division may also reverse the findings of the search opinion for reasons other than those above (see B-III, 1.1), however, such cases should be exceptional.

### 2. Basis of the search opinion

Where the application is a European application not derived from an International application, the applicant cannot amend his application before the search report has been communicated to him. Consequently, in these cases, the search opinion will always relate to *Art. 123(1)*  
*Rule 137(1)*

the application documents as originally filed. Furthermore, any reply filed by the applicant in response to an invitation according to Rule 63(1) (see B-VIII, 3.4) will also be taken into consideration when drawing up the search opinion.

*Rule 161(2)*

*Rule 159(1)(b)*

*Art. 19 PCT*

*Art. 34(2)(b) PCT*

However, where the application under consideration derives from an International application and is subject to a supplementary European search according to Art. 153(7) (see B-II, 4.3), the applicant will have had the opportunity to amend his application both in the International phase and also upon entry into the European phase. The search opinion will then be based on the application documents constituting the latest filed request from the applicant (this may involve the cancellation of amendments previously filed and consequent reversion in part or in full to an earlier set of application documents). The supplementary European search report is also based on these application documents (see B-II, 4.3, and B-III, 3.3.2).

Where the search opinion and supplementary European search report are based on such amendments but Rule 137(4) has not been satisfied (see H-III, 2.1), a communication according to Rule 137(4) (see B-VIII, 6 and H-III, 2.1.1) cannot be sent at this stage (before preparation of the search opinion) because the application is not yet under the responsibility of the Examining Division (see C-II, 1). However, once the Examining Division has assumed responsibility for the application, it may send such a communication, provided that the amendments in question have not been withdrawn or superseded (see H-III, 2.1.1) and only where the application is of one of the types mentioned in H-III, 2.1.4.

### **2.1 Applications containing missing parts of description and/or drawings filed under Rule 56 EPC or Rule 20 PCT**

If the Receiving Section decided not to re-date the application under Rule 56(2) or (5), but the search examiner is of the opinion that the subsequently filed missing parts are not "completely contained" in the priority document and/or the requirements of Rule 56(3) are not fulfilled, he should carry out the search also taking into account prior art which might become relevant for assessing novelty and inventive step of the subject-matter claimed if the application were re-dated pursuant to Rule 56(2) or (5). The search opinion must include a warning that the application seems not to fulfil the requirements laid down in Rule 56 for maintaining the accorded date of filing, a statement of reasons as to why this is the case and an indication that a formal decision as to whether to re-date the application will be taken at a later stage by the Examining Division. If appropriate, the search opinion may also include comments about the effect of re-dating on the priority claim and/or the status of the prior art documents cited in the search report.

The procedure for a Euro-PCT application is similar to that set out above. If when carrying out a supplementary European search the examiner finds that the subsequently filed missing parts are not

"completely contained" in the priority document, despite the fact that the Receiving Office did not re-date the application under Rule 20.5(d) PCT, the search opinion must include a warning that the application seems not to comply with the requirements of Rule 20.6 PCT (Rule 82*ter*.1(c) PCT), a statement of reasons as to why this is the case and an indication that a formal decision as to whether to re-date the application will be taken at a later stage by the Examining Division.

However, if the application has been re-dated by the Receiving Section or receiving Office, but the search examiner has reasons to believe that the application meets the requirements of Rule 56(3) (or Rule 20.6 PCT), he must indicate in the search opinion that decisions given by the Receiving Section (or the receiving Office) may be reconsidered at a later stage by the Examining Division, except where the latter is bound by a decision of the Board of Appeal.

## **2.2 Applications containing claims filed after the accorded date of filing**

Where the application documents contain one or more claims filed after the accorded date of filing (Rules 40(1), 57(c) and 58), the search examiner is required to examine whether or not the one or more claims fulfil the requirements of Art. 123(2) in the light of the technical content of the application documents filed at the accorded date of filing. If the claims do not meet the requirements of Art. 123(2), the search is carried out in accordance with B-VIII, 6.

Where the search opinion and search report are based on late-filed claims but Rule 137(4) has not been satisfied (see H-III, 2.1), a communication according to Rule 137(4) (see H-III, 2.1.1) cannot be sent at this stage (before preparation of the search opinion) because the application is not yet under the responsibility of the Examining Division (see C-II, 1). However, once the Examining Division has assumed responsibility for the application, it may send such a communication, provided that the late-filed claims have not been superseded (see H-III, 2.1.1) and only where the application is of one of the types mentioned in H-III, 2.1.4.

## **3. Analysis of the application and content of the search opinion**

Where it is held that the application and/or the invention to which it relates does not satisfy the requirements of the EPC, then corresponding objections are raised in the search opinion.

The search opinion should, as a general rule, cover all objections to the application (but see B-XI, 3.4). These objections may relate to substantive matters (e.g. the subject-matter of the application is not patentable) or to formal matters (e.g. failure to comply with one or more of the requirements specified in Rules 41 to 43, 46 and 48 to 50) or to both.



*Art. 53(c)*

Where claims relating to a method of treatment of the human or animal body or methods of diagnosis practiced on the human or animal body have been searched because their reformulation into an allowable format can be envisaged at the time of the search (see B-VIII, 2), the search opinion should, nonetheless, object to these claims as relating to subject-matter which is excluded from patentability.

*Rule 62*

### **3.1 The examiner's dossier**

The examiner's first step is to study the description, drawings (if any) and the claims of the application. In carrying out his task, the examiner will have access to the documents making up the European application and a complete history of the proceedings up to the start of search. However, the priority documents together with any translations may not yet be available at this stage (see B-XI, 4).

### **3.2 Reasoned objections**

For each objection the search opinion should indicate the part of the application which is deficient and the requirement of the EPC which is not met, either by referring to specific Articles or Rules, or by other clear indication; it should also give the reason for any objection where this is not immediately apparent. For example, where prior art is cited and only part of a cited document is relevant, the particular passage relied upon should be identified. If the cited prior art is such as to demonstrate lack of novelty or inventive step in the independent claim or claims, and if, consequently, there is lack of unity between dependent claims (see F-V, 9), the applicant should be informed of this situation (see H-IV, 4.2(i)). Substantive matters should normally be set out first. The search opinion should be drafted in such a manner as to facilitate later examination of the amended application and, in particular, to avoid the need for extensive rereading (see C-IV, 2).

If in the search report the examiner has cited a document of category "X" or "Y" against a given claim, the examiner in the search opinion should raise a novelty or inventive step objection against the same claim. Where this relates to a dependent claim and detailed reasoning is given in support of objections to the related independent claim, only short comments for that dependent claim are required.

### **3.3 Comments and amendments in response to the search opinion**

Subject to certain exceptions, the applicant is required to respond to the search opinion (see B-XI, 8).

### **3.4 Extent of first analysis**

It is emphasised that the first sentence of B-XI, 3 only sets out the general rule. There may be cases in which the application is generally deficient. In these cases the examiner should not carry out a detailed analysis, but should send a search opinion to the applicant informing him of this fact, mentioning the major deficiencies and saying that

when the application enters the examination stage, further examination will be deferred until these have been removed by amendment. There may be other cases in which, although a meaningful analysis is possible, a fundamental objection arises, e.g. it is clear that certain claims lack novelty and that the statement of claim will have to be drastically recast, or there are substantial amendments (International applications entering the European phase - see B-XI, 2) which are not allowable either because they introduce new matter not present in the application as filed (Art. 123(2)), or they introduce other deficiencies (e.g. the amendment makes the claims unclear - Art. 84). In such cases, it may be more appropriate to deal with this objection before making a detailed analysis; if, e.g. the claims need recasting, it may be pointless to raise objections to the clarity of some dependent claims or to a passage in the description which may have to be amended or even deleted in examination proceedings as a consequence. However, if there are other major objections these should be dealt with. Generally, the examiner should seek to make the maximum impact in the search opinion with the broad aim of facilitating as efficient a decision making process as possible in later examination proceedings.

### **3.5 Contribution to the known art**

When analysing the application, the examiner should concentrate on trying to understand what technical contribution the invention as defined in the claims adds to the known art. This should normally be sufficiently clear from the application as filed. If it is not, an objection should be raised in the search opinion (see F-II, 4.5); but the examiner should not raise an objection of this kind unless he is convinced it is necessary, since to do so might result in the applicant introducing additional subject-matter and thus offending against Art. 123(2) (see H-IV, 2 and H-V).

*Rule 42(1)(c)*

### **3.6 EPC requirements**

Although the examiner must bear in mind all the requirements of the EPC, the requirements which are most likely to require attention in the majority of cases are, in particular: sufficiency of disclosure (see F-III); clarity and support in the description, especially of the independent claims (see F-IV, 4 and 6); novelty (see G-VI); and inventive step (see G-VII).

### **3.7 Examiner's approach**

The examiner should not require or suggest amendments merely because he thinks they will improve the wording of the description or claims. A pedantic approach is undesirable; what is important is that the meaning of the description and claims should be clear. Also, while any serious inconsistencies between the claims and the description as filed should be objected to (see F-IV, 4.3), if the claims appear to require substantial amendment, adaptation of the description to the amended claims is better left until the final form of at least the main claims has been settled in examination proceedings.

### 3.8 Making suggestions

It must be emphasised that it is not part of the duty of an examiner to require the applicant to amend the application in a particular way to meet an objection, since the drafting of the application is the applicant's responsibility and he should be free to amend in any way he chooses provided that the amendment removes the deficiency and otherwise satisfies the requirements of the EPC. However, it may sometimes be useful if the examiner suggests at least in general terms an acceptable form of amendment, but if he does so he should make it clear that the suggestion is merely for the assistance of the applicant and that other forms of amendment will be considered in examination proceedings.

### 3.9 Positive opinion

After the analysis referred to in B-XI, 3.1 to 3.8 has been made, the Search Division may come to the conclusion that the application and the invention to which it relates both satisfy the requirements of the EPC. In this case the search opinion contains a statement giving a general positive opinion on the application documents. However, where it is not possible to conclude the search for all potentially conflicting applications according to Art. 54(3) at the time of the search (see B-VI, 4.1), a top-up search will have to be carried out in the examination procedure (see C-IV, 7.1) and subsequently objections according to Art. 54(3) will be raised if appropriate.

Where minor amendments of the application documents would be necessary for the application to proceed to grant, a positive search opinion can still be issued. Thereafter, subject to no prior art according to Art. 54(3) being found in any subsequent top-up search, the Rule 71(3) communication can then be issued in examination proceedings, with those minor amendments being proposed by the Examining Division according to C-V, 1.1.

In the above cases, the applicant is not required to respond to the search opinion (see B-XI, 8).

At the search stage, it is not possible to officially designate an Examining Division, since responsibility for the application lies with the Receiving Section (Art. 16). However, the prospective members of the Examining Division are already indicated. Thereafter, the examiner should consult the other prospective members of the Examining Division to ensure that they agree to the issuing of a positive search opinion.



#### **4. Priority claim and the search opinion**

When it is not possible to check the validity of the priority claim at the search stage, because:

- (i) the search is carried out before the date on which the priority document must be supplied (up to 16 months from the earliest claimed priority - Rule 53(1))
- (ii) a translation of the priority document is required but not available to the Search Division at the time of drafting the search opinion (Rule 53(3), A-III, 6.8 and sub-sections, and F-VI, 3.4)

then, for the purposes of drafting the search opinion, the priority claim will usually be assumed to be valid. Where at this stage the only objections which can be raised against the application depend on the priority being invalid, and the priority document (or its translation) is not available, the examiner should issue an entirely positive search opinion without objections. In case (ii) above, a communication according to Rule 53(3) may be issued as specified in A-III, 6.8.1, and the validity of the priority subsequently reviewed in examination proceedings.

However, if an assessment of the validity of the priority claim is necessary as a result of intermediate prior art or potential state of the art according to Art. 54(3), and evidence is already available undermining the validity of the priority claim, then this should be brought up in the search opinion. For example, where the priority document is available at the time of drafting the search opinion and technical features of the claims are not present in the priority document, this may even be possible where a translation is required, but the examiner is familiar with the language of the priority document (see also B-VI, 5.3).

##### **4.1 Use of "P" and "E" documents in the search opinion**

Where a document relating to potential prior art according to Art. 54(3) is referred to in the search opinion, two situations may arise, depending on whether or not the examiner can conclusively establish that said prior art document has an earlier relevant date than that of the application. If so, the examiner should raise an objection under Art. 54(3). If not, he should assume that any priority which cannot be checked is valid. This leads to two different scenarios:

- (i) The prior art document is comprised in the state of the art under Art. 54(3). The examiner consequently raises an objection under Art. 54(3) in the search opinion and indicates which priorities have been assumed to be valid;
- (ii) The prior art document does not belong to the state of the art under Art. 54(3). Where the search opinion raises other

objections, it will refer to the document potentially falling under Art. 54(3) (and its relevant passages) and will explain which priorities have been assumed valid.

Where there are also "P" documents cited in the search report and these are not potential Art. 54(3) documents (because they are not international or European patent applications), these documents may constitute prior art under Art. 54(2) and thus be relevant for the assessment of novelty and inventive step insofar as the priority of the application is not valid. Where the priority of the application can be checked, the examiner checks the priority and makes objections in the search opinion based on the "P" documents if the priority is not valid. If the priority of the application cannot be checked, it is assumed to be valid and no objection is raised in the search opinion.

The issue of the validity of the priority claim(s) then needs to be reviewed in examination (see F-VI, 2).

### **5. Unity in relation to the search opinion**

Where the Search Division finds that the claimed invention does not meet the requirement of unity of invention (Art. 82 and Rule 44(1) and (2)), the Search Division sends the applicant an invitation to pay additional search fees and the partial search report relating to the invention or unitary group of inventions first mentioned in the claims (see B-VII, 1.1, 1.2 and 1.3 and Rule 64(1)). The invitation and partial search report are not accompanied by a search opinion.

After the time limit for payment of the additional search fees has expired, (Rule 64(1)) the applicant is sent a search report relating to the invention or unitary group of inventions first mentioned in the claims and all other claimed inventions or unitary groups of inventions in respect of which additional search fees have been paid. This is accompanied by a search opinion containing:

- (i) the reasoning behind the lack of unity
- (ii) an opinion on the first invention or unitary group of inventions mentioned in the claims
- (iii) an opinion on all inventions or unitary groups of inventions in respect of which additional search fees have been paid

For supplementary European search reports on Euro-PCT applications lacking unity of invention, the same procedure is followed (Rule 164(1) - see B-VII, 2.3).



### **6. The search opinion in cases of a limitation of the search**

Any argumentation and objections presented in the search opinion must be consistent with limitations of the search and the reasons therefor. This applies to limitations for reasons of non-patentability (e.g. business methods - Art. 52(2)(c), see B-VIII, 1), for reasons of



severe deficiencies prejudicing a meaningful search (Rule 63, see B-VIII, 3) or due to a contravention of Rule 43(2) (Rule 62a, see B-VIII, 4). In these cases, the search opinion will also contain the information indicated in B-VIII, 3.3 and 4.3.

Where claims are deemed abandoned by reason of non-payment of a claims fee (Rule 45 or Rule 162) and are consequently not searched, the search opinion will draw the applicant's attention to this fact.

#### **7. No search opinion is issued**

Where the applicant has filed the request for examination according to Rule 70(1) before the search report has been communicated to him and has waived the right to receive the communication under Rule 70(2) (see C-II, 1(ii)), the despatch of the search report to the applicant causes the application to enter the competence of the Examining Division (Art. 18(1) and Rule 10(2)).

In this case, where the application contains deficiencies, the Examining Division will issue a communication according to Art. 94(3) in place of the search opinion. Failure to respond to this communication results in deemed withdrawal of the application according to Art. 94(4) (see C-III, 4.2).

If the application is ready for grant, the procedure is as follows:

- (i) Where the search for conflicting applications according to Art. 54(3) was complete:

The Examining Division will issue a communication according to Rule 71(3)

- (ii) Where the search for conflicting applications according to Art. 54(3) was not complete:

The applicant is informed that the application is in order for grant, on condition that no state of the art according to Art. 54(3) is found to exist when the top-up search is completed (see B-XI, 3.9). This is purely for information and no response from the applicant is required.

#### **8. Reaction to the extended European search report (EESR)**

The applicant is required to respond to the search opinion within the time limit for filing the request for examination provided for under Rule 70(1) (see C-II, 1).

*Rule 70a(1)*

*Rule 70a(2)* If, however, the applicant filed the request for examination before the search report and the search opinion were transmitted to him (according to Art. 94(1) this also requires payment of the examination fee), he is sent a communication according to Rule 70(2) requesting him to indicate whether he wishes to proceed further with the application within a period to be specified (see C-II, 1(i)). In these cases, the applicant must respond to the search opinion within the time period set under Rule 70(2). This always applies to Euro-PCT applications subject to preparation of the supplementary European search report and search opinion (see B-II, 4.3 and E-VIII, 2.5.3), except where the applicant has waived the communication according to Rule 70(2) (see C-II, 1(ii)), in which case the procedure under B-XI, 7 applies.

*Rule 70a(3)*  
*Rule 112(1)* Failure to respond to the search opinion within the applicable period results in the application being deemed to be withdrawn, and the applicant is notified accordingly. In response to this communication of a loss of rights, the applicant can request further processing in accordance with Art. 121 and Rule 135.

There is, however, no requirement for the applicant to respond to the European or supplementary European search report where this was drawn up before 1 April 2010, where it is not accompanied by a search opinion (see B-XI, 1.1 for applications for which a search opinion is prepared) or where the search opinion was positive (see B-XI, 3.9). However, in these cases, the applicant *may* still respond to the search report according to Rule 137(2) if he so wishes. In such cases, the applicant is encouraged to respond to the search report before the application enters the examination stage (see C-II, 1).

The applicant responds to the search opinion by filing amended application documents according to Rule 137(2) (see C-II, 3.1) (where amended claims are filed before publication, see A-VI, 1.3, paragraph 2) and/or by filing his observations on the objections raised in the search opinion, either in addition to, or in place of, such amendments. Such amendments and/or observations will only be examined by the Examining Division if the application enters the examination stage. Likewise, telephone conversations and personal interviews can only take place after the application has entered the examination stage, with the exception of the cases indicated in B-VIII, 3.2, and 4.2. The examiner must not consent to these earlier.

Procedural requests, such as a request for a personal interview or for oral proceedings, do not constitute a valid reply where these are made without comment on any of the objections raised in the search opinion. In cases where such a request is the only response to the search opinion on expiry of the applicable time limit, the application is deemed to be withdrawn according to Rule 70a(3). The same applies for a request which, at this stage, cannot be considered (e.g. request according to the state of the file).

For applications for which a search opinion was prepared but where the search report was drawn up before 1 April 2010, if the applicant does not reply to the search opinion and the application enters the examination stage (see C-II, 1 and 1.1), a communication referring to the search opinion and setting a time limit for reply will be issued by the Examining Division as the first communication under Art. 94(3) (see C-III, 4). Failure to respond to this communication in due time will result in the application being deemed withdrawn according to Art. 94(4).

Where the applicant files amendments in response to the search opinion, if Rule 137(4) is not complied with (see H-III, 2.1), a communication according to Rule 137(4) (see H-III, 2.1.1) may be sent in respect of these amendments only after the application has passed to the responsibility of the Examining Division (see C-II, 1) and only where the application is of one of the types mentioned in H-III, 2.1.4.

#### **9. Art. 124 and the utilisation scheme**

When drafting the search opinion, the examiner should take into consideration any prior art document provided by the applicant under Rule 141(1) or by the office of first filing under Rule 141(2) (see OJ EPO 2011, 62, and OJ EPO 2012, 540), if available at the time of preparing the opinion (see A-III, 6.12, and B-IV, 1.3). Requests for information on prior art under Rule 141(3) may be made only when the application has entered the examination phase (see C-III, 5).

*Art. 124*

*Rule 141*



# **Part C**

## **Guidelines for Procedural Aspects of Substantive Examination**



## Contents

### **Chapter I – Introduction I-1**

- 1. **General remark I-1**
- 2. **Work of an examiner I-1**
- 3. **Overview I-1**
- 4. **Purpose of examination I-1**

### **Chapter II – Formal requirements to be met before the Division starts substantive examination II-1**

#### **1. Request for examination II-1**

- 1.1 Confirmation of the intention to proceed further with the application II-1
- 1.2 Euro-PCT applications II-2
- 1.3 Invention to be examined II-2

#### **2. Allocation of the application II-2**

#### **3. Response filed before first communication in examination II-3**

- 3.1 Response to the search opinion II-3
- 3.2 Response to PCT actions prepared by the EPO II-4
- 3.3 The invitation under Rule 70a(1) II-4

#### **4. Designation fee(s), extension fees II-5**

#### **5. Copy of the search results on the priority or priorities II-5**

### **Chapter III – The first stage of examination III-1**

- 1. **Missing drawings or parts of the description filed under Rule 56 or claims filed after accordance of a date of filing III-1**



<b>2.</b>	<b>Amendments made by the applicant of his own volition</b>	<b>III-2</b>
2.1	Amendments made in response to the search opinion	III-2
2.2	Amendments made in response to the WO-ISA, IPER or supplementary international search report	III-2
2.3	Searches under Rule 164(2)	III-3
<b>3.</b>	<b>Unity of invention</b>	<b>III-5</b>
3.1	Relation to unity in search; limitation to searched invention	III-5
3.1.1	No additional search fees paid	III-5
3.1.2	Additional search fees paid	III-6
3.2	Excision of other inventions; filing divisional applications	III-6
3.3	Refund of additional search fees	III-7
3.4	Changing from one searched invention to another	III-8
<b>4.</b>	<b>First communication</b>	<b>III-8</b>
4.1	Reasoned objections	III-8
4.2	Invitation to file comments and amendments	III-9
<b>5.</b>	<b>Requesting information on prior art (not confined to priority)</b>	<b>III-9</b>
<b>6.</b>	<b>Evaluation of prior art documents cited in search report and late priority claim</b>	<b>III-9</b>
<b>Chapter IV – Examination of replies and further stages of examination</b>		<b>IV-1</b>
<b>1.</b>	<b>General procedure</b>	<b>IV-1</b>
<b>2.</b>	<b>Extent of examination of replies</b>	<b>IV-1</b>
<b>3.</b>	<b>Further action upon examination of replies</b>	<b>IV-2</b>
<b>4.</b>	<b>Later stages of examination</b>	<b>IV-2</b>
<b>5.</b>	<b>Examination of amendments</b>	<b>IV-3</b>
<b>6.</b>	<b>Admissibility of amendments made by the applicant</b>	<b>IV-3</b>



<b>7.</b>	<b>Search-related issues in examination</b>	<b>IV-3</b>
7.1	Search for conflicting European applications	IV-3
7.2	Additional searches during examination	IV-4
7.3	Search at the examination stage	IV-5
7.4	Citing documents not mentioned in the search report	IV-5

## **Chapter V – The final stage of examination** **V-1**

<b>1.</b>	<b>Communication under Rule 71(3)</b>	<b>V-1</b>
1.1	Text for approval	V-1
1.2	Grant and publishing fee	V-2
1.3	Translations of the claims	V-3
1.4	Claims fees due in response to Rule 71(3) communication	V-3
1.5	Other information in the communication under Rule 71(3)	V-3
<b>2.</b>	<b>Grant of a patent</b>	<b>V-4</b>
<b>3.</b>	<b>Application deemed withdrawn</b>	<b>V-5</b>
<b>4.</b>	<b>Amendments or corrections filed in reply to a Rule 71(3) communication</b>	<b>V-5</b>
4.1	No payment of fees or filing of translations necessary	V-5
4.2	Crediting of fees paid voluntarily	V-5
4.3	Amendments or corrections should be reasoned	V-6
4.4	Admissibility of amendments	V-6
4.5	Adaptation of the description	V-6
4.6	Amendments/corrections admitted and allowable - second Rule 71(3) communication sent	V-7
4.6.1	Applicant rejects amendments proposed by Examining Division in first Rule 71(3) communication	V-7
4.6.2	Second Rule 71(3) invitation based on higher request initially rejected in first Rule 71(3) invitation	V-7

---

4.6.3	Examining Division proposes amendments in second Rule 71(3) communication	V-7
4.7	Amendments not admitted and/or not allowable, examination resumed	V-8
4.7.1	Communications/oral proceedings after resumption	V-8
4.7.2	Agreement reached on a text - second Rule 71(3) communication	V-9
4.7.3	No agreement reached on a text - refusal	V-9
4.8	Fees to be paid within the second Rule 71(3) period	V-9
4.8.1	Claims fees	V-9
4.8.2	Fee for grant and publishing	V-10
4.9	Applicant disapproves of the text proposed for grant	V-10
4.10	Amendments/corrections filed in second Rule 71(3) period	V-11
<b>5.</b>	<b>Further requests for amendment after approval</b>	<b>V-11</b>
<b>6.</b>	<b>The Examining Division resumes examination after approval of the text</b>	<b>V-12</b>
6.1	When does the Examining Division resume examination after approval?	V-12
6.2	A further communication under Rule 71(3)	V-12
6.3	Crediting of fees under Rule 71a(5)	V-12
<b>7.</b>	<b>Correction of errors in the decision to grant</b>	<b>V-12</b>
<b>8.</b>	<b>Further processing</b>	<b>V-13</b>
<b>9.</b>	<b>Refund of the fee for grant and publishing</b>	<b>V-13</b>
<b>10.</b>	<b>Publication of the patent specification</b>	<b>V-13</b>
<b>11.</b>	<b>Withdrawal before publication of the patent specification</b>	<b>V-14</b>
<b>12.</b>	<b>Certificate</b>	<b>V-14</b>
<b>13.</b>	<b>European Patent Bulletin</b>	<b>V-14</b>
<b>14.</b>	<b>Refusal</b>	<b>V-14</b>

<b>15.</b>	<b>Decision according to the state of the file</b>	<b>V-15</b>
15.1	The request for a decision according to the state of the file	V-15
15.2	Decision by means of a standard form	V-16
15.3	Issuing a self-contained decision	V-16
15.4	Issuing a further communication (no refusal)	V-16
<b>Annex</b>	<b>Standard marks for indicating amendments or corrections by the Divisions</b>	<b>V-17</b>

## **Chapter VI – Time limits and acceleration of examination**

### **VI-1**

<b>1.</b>	<b>Time limits for response to communications from the examiner</b>	<b>VI-1</b>
1.1	General considerations	VI-1
1.2	Special circumstances	VI-1
<b>2.</b>	<b>Influencing the speed of examination proceedings - PACE</b>	<b>VI-1</b>
<b>3.</b>	<b>Further ways to accelerate examination</b>	<b>VI-1</b>

## **Chapter VII – Other procedures in examination**

### **VII-1**

<b>1.</b>	<b>General remark</b>	<b>VII-1</b>
<b>2.</b>	<b>Telephone conversation, personal interview, e-mail</b>	<b>VII-1</b>
2.1	Request for an interview; arranging an interview	VII-1
2.2	Persons attending the interview	VII-1
2.3	Conduct of an interview or telephone conversation	VII-2
2.4	Effect of statements made in an interview or by telephone	VII-2
2.5	Minutes of an interview or telephone conversation	VII-3
2.6	Use of e-mail	VII-4
2.6.1	Examples of where e-mail could be used	VII-4
2.6.2	Initiation of e-mail	VII-5

2.6.3	Confidentiality	VII-5
2.6.4	Filing of amended documents and new requests	VII-5
2.6.5	Inclusion in the file of any e-mail exchange	VII-5
<b>3.</b>	<b>Taking of evidence</b>	<b>VII-6</b>
3.1	General remark	VII-6
3.2	Producing evidence	VII-6
3.3	Written evidence	VII-6
<b>4.</b>	<b>Oral proceedings</b>	<b>VII-6</b>
<b>5.</b>	<b>Examination of observations by third parties</b>	<b>VII-6</b>
<b>Chapter VIII – Work within the Examining Division</b>		<b>VIII-1</b>
<b>1.</b>	<b>General remarks</b>	<b>VIII-1</b>
<b>2.</b>	<b>Recommendation to grant</b>	<b>VIII-2</b>
<b>3.</b>	<b>Recommendation to refuse</b>	<b>VIII-2</b>
<b>4.</b>	<b>Tasks of the other members of the Examining Division</b>	<b>VIII-2</b>
<b>5.</b>	<b>Further communication with the applicant</b>	<b>VIII-3</b>
<b>6.</b>	<b>Decision</b>	<b>VIII-3</b>
<b>7.</b>	<b>Enlargement of the Examining Division; consultation of a legally qualified examiner</b>	<b>VIII-3</b>
<b>Chapter IX – Special applications</b>		<b>IX-1</b>
<b>1.</b>	<b>Divisional applications (see also A-IV, 1)</b>	<b>IX-1</b>
1.1	General remarks	IX-1
1.2	Voluntary and mandatory division	IX-1
1.3	Abandonment of subject matter	IX-1
1.4	Examination of a divisional application	IX-1
1.5	Description and drawings	IX-2
1.6	Claims	IX-3



---

<b>2.</b>	<b>Applications resulting from a decision under Art. 61</b>	<b>IX-3</b>
2.1	General remarks	IX-3
2.2	Original application no longer pending	IX-4
2.3	Partial entitlement	IX-4
2.4	Entitlement for certain designated States only	IX-4
<b>3.</b>	<b>Applications where a reservation has been entered in accordance with Art. 167(2)(a) EPC 1973</b>	<b>IX-4</b>
<b>4.</b>	<b>International applications (Euro-PCT applications)</b>	<b>IX-4</b>



## Chapter I – Introduction

### 1. General remark

In this Part C of the Guidelines the term "examiner" is used to mean the examiner entrusted with substantive examination forming part of the Examining Division, which is responsible for the final decision.

*Art. 18*

Chapters C-II to IX set out the general procedure for examination, together with guidance on particular matters where necessary. They do not provide detailed instructions on matters of internal administration.

### 2. Work of an examiner

The attitude of the examiner is very important. He should always try to be constructive and helpful. While it would of course be quite wrong for an examiner to overlook any major deficiency in an application, he should have a sense of proportion and not pursue unimportant objections. He should bear in mind that, subject to the requirements of the EPC, the drafting of the description and claims of a European application is the responsibility of the applicant or his authorised representative.

== The attention of the examiner is particularly directed to the instruction in paragraph 4 of the General Part of the Guidelines. This applies not only in relation to other departments of the EPO. It also means, for example, that the other members of an Examining Division should not attempt to repeat the work of the primary examiner (see C-VIII, 4).

### 3. Overview

Part C of the Guidelines deals with matters of examination procedure (see Chapters C-II to IX).

Matters of substantive law, i.e. the requirements which a European application must fulfil, are dealt with in Parts F, G and H.

### 4. Purpose of examination

The purpose of preparing the search opinion (see B-XI) and of the subsequent examination proceedings is to ensure that the application and the invention to which it relates meet the requirements set out in the relevant Articles of the EPC and the Rules of its Implementing Regulations. The prime task of the Examining Division is to deal with the substantive requirements; the criteria by which an examiner judges whether they have been met are dealt with in detail, insofar as appears necessary, in Parts F, G and H. As for the formal requirements (see Part A), these are initially the responsibility of the Receiving Section.

*Art. 94(1)*

*Art. 164(1)*

*Rule 62(1)*

*Rule 70(2)*

The examination is to be carried out in accordance with Art. 94(3) and (4), Art. 97, Rule 71(1) to 71(7), Rule 71a(1) to 71a(6) and Rule 72. The examiner's first step is to study the description, drawings (if any) and the claims of the application. However, as the examiner will normally already have done this when he carried out the search (see B-XI, 3), he should concentrate on any amendments and/or comments filed by the applicant in response to the search opinion (see B-XI, 8). If amendments were made and these have not been identified and/or their basis in the application as filed not indicated by the applicant (see H-III, 2.1) and the application is one of those mentioned in H-III, 2.1.4, the Examining Division may send a communication according to Rule 137(4) requesting the applicant to provide this information (see H-III, 2.1.1).



## Chapter II – Formal requirements to be met before the Division starts substantive examination

### 1. Request for examination

In order that examination of a European application can begin, the applicant is required to file a request for examination, which, however, is not deemed to be filed until after the examination fee has been paid. The request for examination may be filed from the date on which the application is filed up to the end of six months after the date on which the European Patent Bulletin mentions the publication of the European search report. If the request for examination is not filed within this period, the application is deemed to be withdrawn. However, in such a case, the applicant has the possibility of filing a request for further processing pursuant to Art. 121. According to Rule 70(1), the request for examination may not be withdrawn.

*Art. 94*  
*Art. 121*  
*Rule 70*  
*Art. 122(4)*  
*Rule 136(3)*

Subject to certain exceptions, the applicant must also respond to the search opinion within the above-mentioned period for filing the request for examination (see B-XI, 9 and C-II, 3.1), unless the EPO invites him to confirm an early request for examination according to Rule 70(2), in which case he must respond to the search opinion within the period provided for under Rule 70(2) (see C-II, 1.1).

*Rule 70a(1) and (3)*

Responsibility for examining the application passes from the Receiving Section to the Examining Division at the time when a request for examination is filed. This is subject to two exceptions:

*Rule 10*  
*Rule 70(2)*

- (i) if the applicant has filed a request for examination before the European search report has been sent to him, then the Examining Division is responsible only from the time when the confirmation of the request is received by the EPO following an invitation under Rule 70(2);
- (ii) if the applicant has filed a request for examination before the European search report has been sent to him and has also waived the right to receive an invitation to confirm under Rule 70(2) (see C-VI, 3), then the Examining Division is responsible only from the time when the search report is sent to the applicant.

#### 1.1 Confirmation of the intention to proceed further with the application

If the applicant has filed a request for examination before the search report has been transmitted to him, the EPO will invite him to confirm, within a six-month period, that he desires to proceed further with his application. This six-month period is calculated from the mention of the publication of the European search report. Where the applicant also has to respond to the search opinion, his response is required within

*Rule 70(2) and (3)*  
*Art. 121*  
*Art. 11 RFees*  
*Rule 70a(2) and (3)*



this same period (see B-XI, 8 and C-II, 3.1). In these cases, the applicant's response to the search opinion is interpreted as the confirmation required by Rule 70(2), even where not explicitly expressed as such. If the applicant fails to confirm his desire to proceed further with the application in due time in reply to this invitation, the application will be deemed to be withdrawn. In this case, however, the means of redress provided for in Art. 121 (further processing of the application) will apply (see A-VI, 2.2 and 2.3). For the conditions applicable to a refund of the examination fee if the application is withdrawn, refused or deemed to be withdrawn, see A-VI, 2.5.

### 1.2 Euro-PCT applications

*Art. 153(4), (6) and (7)*  
*Art. 150(2)*  
*Rule 159(1)(f)*

If the application has proceeded via the PCT (Euro-PCT application), the six-month period under Rule 70(1) begins with the publication of the PCT search report or the declaration under Art. 17(2)(a) PCT. However, as is laid down in Art. 150(2), the time limit for requesting examination in a Euro-PCT case does not expire before the time prescribed in Art. 22 PCT and Art. 39 PCT (i.e. not before the time limit of Rule 159(1)(f)). The time limit will not be affected by whether a supplementary European search pursuant to Art. 153(7) needs to be made or whether the international application pursuant to Art. 153(4) is again published by the EPO.

*Art. 121*  
*Rule 136(3)*  
*Rule 160(1)*

If the request for examination of a Euro-PCT application has not been filed within the time limit, the application is deemed withdrawn under Rule 160(1). In such a case, however, the applicant has the possibility of filing a request for further processing pursuant to Art. 121.

Where the Euro-PCT application is subject to the preparation of a supplementary European search report (see B-II, 4.3), once this search report to the applicant has been dispatched to him, the applicant is sent a communication according to Rule 70(2), inviting him to confirm the request for examination within six months of the notification of that communication (see E-VIII, 2.5.3).

### 1.3 Invention to be examined

*Rule 36*

It is to be noted that where the search report and the search opinion have been drawn up to cover several inventions lacking unity, the applicant is free to select the invention to be examined in the application under consideration. The others will be subject to objections of lack of unity and may be divided out according to Rule 36 (see C-III, 3.2 and C-IX, 1.3).

## 2. Allocation of the application

The dossier will normally be allocated to an Examining Division responsible for the examination of applications in the technical field in which the particular application has been classified by the Search Division or ISA which carried out the search. It is usual for the primary examiner entrusted with the examination of the application in accordance with Art. 18(2) to be the same person who prepared the

(supplementary) European search report and search opinion or, where the EPO was the ISA or the authority specified for the supplementary international search, the international search report and WO-ISA or the supplementary international search report.

There may, however, be instances where it is appropriate to allocate the application to an Examining Division comprising examiners who are not normally responsible for the indicated part of the IPC and who might not have been involved at the search stage. There are a number of possible reasons for this: e.g. to make it possible, where appropriate, that an original and a divisional application are dealt with by the same Examining Division (this could sometimes be more efficient even when the two applications are classified in different technical fields); or if the classification of the published application does not correspond to the subject-matter of the application in the form in which it reaches the substantive examiner (e.g. because the application has been amended after receipt of the search report and search opinion).

### **3. Response filed before first communication in examination**

#### **3.1 Response to the search opinion**

Following receipt of the search report and search opinion, and prior to the first communication from the examining division, the applicant must (subject to certain exceptions) respond to the search opinion, by filing amendments to the description, claims or drawings and/or filing his observations on the objections raised in the search opinion (see B-XI, 8 for details, in particular as to the exceptions where no reply is required). In order to avoid delays, care should be taken to comply with the requirements of Rule 137(4) when filing such amendments (see OJ EPO 2009, 533, point 7). Any amendments filed at this stage are made by the applicant of his own volition in accordance with Rule 137(2) (for more details, see C-III, 2.1).

*Rule 137(2)*  
*Rule 70(2)*  
*Rule 70a*

The applicant's response to the search opinion required by Rule 70a (or filed voluntarily in response to search opinions not requiring a response) will be taken into account by the Examining Division when drafting the first communication. Failure to respond to this communication in due time will result in the application being deemed withdrawn according to Art. 94(4), although this loss of rights is subject to further processing (with regard to what constitutes a valid response, see B-XI, 8).

*Art. 94(3) and (4)*  
*Rule 62(1)*

If the European search report or supplementary European search report was accompanied by a search opinion but was drawn up before 1 April 2010 (such that a reply to the search opinion was not mandatory - see B-XI, 8) and the applicant did not reply to it, a communication referring to the search opinion and setting a time limit for reply would have been issued as the first communication under Art. 94(3). Failure to respond to this communication in due time would

have resulted in the application being deemed withdrawn according to Art. 94(4).

The procedure explained in the above paragraphs also applies to Euro-PCT applications for which the EPO prepares a supplementary European search report and a search opinion (see B-II, 4.3 and B-XI, 1.1).

### **3.2 Response to PCT actions prepared by the EPO**

*Rule 161(1)*

For Euro-PCT applications where the EPO acted as the International Searching Authority (ISA) and, where a demand under Art. 31 PCT was filed, also as the International Preliminary Examining Authority, or as the authority specified for supplementary international search, the applicant will already have responded to a negative WO-ISA, IPER or supplementary international search report prepared by the EPO (unless the communication under Rule 161 was issued before 1 April 2010 - see E-VIII, 3.3.3).

This response may comprise amendments and/or observations filed in response to the communication under Rule 161(1) (or possibly filed earlier - see E-VIII, 3.3.1). Any amendments filed at this stage are made by the applicant of his own volition in accordance with Rule 137(2) (for more details see C-III, 2.2). This response will be taken into account by the Examining Division when drafting the first communication according to Art. 94(3). For more details, see E-VIII, 4.1, 4.2 and 4.3.

### **3.3 The invitation under Rule 70a(1)**

Under Rule 70a(1) the applicant is invited to respond to the ESOP within the period referred to in Rule 70(1) or, where applicable, within the period referred to in Rule 70(2) (see B-XI, 8), unless the applicant has waived the communication under Rule 70(2) (see C-VI, 3).

Where the request for examination (including payment of the examination fee) is filed after the search report has been transmitted to the applicant, the applicant must respond to the ESOP within the period referred to in Rule 70(1). In such cases the invitation under Rule 70a(1) is sent in a single communication together with the communication according to Rule 69(1) (see A-VI, 2.1). This combined communication under Rule 70a(1) and Rule 69(1) is issued shortly after the mention of the publication of the European search report in the European Patent Bulletin (in general, this is approximately one week later).

Where the request for examination (including payment of the examination fee) is filed before the search report has been transmitted to the applicant, the applicant must respond to the ESOP within the period referred to in Rule 70(2). In such cases the invitation under Rule 70a(1) is sent in a single communication together with the communication according to Rule 70(2). With regard to how the period referred to in Rule 70(2) is calculated for these cases, see C-II, 1.1, for

Euro-direct applications and C-II, 1.2, for Euro-PCT applications for which a supplementary European search report is prepared.

#### 4. Designation fee(s), extension fees

Under Rule 39(1), the designation fee(s) can be validly paid up to the same time limit as the examination fee and therefore will be generally paid at the same time as the examination fee. The examination whether and to what extent a designation fee has been validly paid has been entrusted to the formalities officer by virtue of Rule 11(3); see the Decision of the President of the EPO dated 12 December 2013, OJ EPO 2014, A6. The same applies to the examination as to whether extension fees have been paid, see A-III, 12.2.

*Rule 39(1)*

*Art. 90(3)*

#### 5. Copy of the search results on the priority or priorities

Where the EPO notes, at the time the Examining Division assumes responsibility, that a copy of the results of a search on the claimed priority or priorities as referred to in Rule 141(1) has not been filed by the applicant and is not deemed to be duly filed under Rule 141(2) (see A-III, 6.12), it invites the applicant to file, within a period of two months, the copy or a statement that the results of the search referred to in Rule 141(1) are not available to him. This requirement applies to European or Euro-PCT applications filed on or after 1 January 2011 (see OJ EPO 2009, 585). This communication is also sent in cases where the priority in question has since been withdrawn or has lapsed.

*Rule 70b(1)*

Failure to reply to this invitation in due time results in the application being deemed to be withdrawn. Further processing is available for this loss of rights (see E-VII, 2.1).

*Rule 70b(2)*

The search results provided by the applicant will be included in the file and will be open to file inspection (see A-XI).



## Chapter III – The first stage of examination

### 1. Missing drawings or parts of the description filed under Rule 56 or claims filed after accordane of a date of filing

Where the applicant has supplied missing drawings or parts of the description after accordane of a filing date (see A-II, 5) under Rule 56, and the Receiving Section has determined that the missing drawings or parts of the description are "completely contained" in the claimed priority application, the application is not re-dated to the date on which the missing drawings or parts of the description were supplied. The Examining Division may review the findings of the Receiving Section on the applicability of Rule 56(3), unless those findings have become final after a decision of a Board of Appeal. Should the Examining Division come to the conclusion that the missing elements are not "completely contained" in the priority document, contrary to the original finding of the Receiving Section, it must communicate this to the applicant and, once it has been established that the right to be heard under Art. 113(1) has been observed, notify him of the new date of filing (see A-II, 5). The Examining Division must also inform the applicant that the missing drawings or parts of the description can still be withdrawn within two months from the date of notification of the new date of filing. If the applicant opts for withdrawal, the re-dating of the application will be deemed not to have been made (see also B-XI, 2.1). For Euro-PCT applications a review is possible under Rule 82ter PCT.

*Rule 56*

If the applicant does not agree with the finding of the Examining Division, he may (within the above time limit) request an appealable decision on the matter. In this case, the examiner will issue a reasoned decision, informing the applicant of the new date of filing, of the reasons for the re-dating and (where appropriate) of the detrimental effect of the re-dating on the claimed priority right. This decision will allow a separate appeal according to Art. 106(2).

*Rule 111*

Once the period for filing an appeal has expired without an appeal being filed, the examiner will resume examination on the basis of the new date of filing.

If the applicant files an appeal in due time, competence for the file passes to the Board of Appeal for reviewing the decision on the accordane of a filing date. While the case is pending before the Board of Appeal, the Examining Division will not continue substantive examination. Once the Board of Appeal has issued a decision, the file will be returned to the examiner, who will be bound on this point by the decision of the Board (Art. 111(2)). He will then resume examination.

If the claims were not present at the date of filing the application, the Examining Division must check whether the subsequently filed claims satisfy the requirements of Art.123(2). If the basis for these subsequently filed claims in the application as filed has not been indicated by the applicant (see H-III, 2.1) and the application is one of

*Art. 123(2)*

those mentioned in H-III, 2.1.4, the Examining Division may send a communication according to Rule 137(4) requesting the applicant to provide this information (see H-III, 2.1.1).

## **2. Amendments made by the applicant of his own volition**

Any amendment, including any made by the applicant of his own volition, must satisfy the following conditions:

*Art. 123(2)*

- (i) it must not add subject-matter to the content of the application as filed (see H-IV, 2.3 and H-V, 1 to 7);
- (ii) it must not itself cause the application as amended to be objectionable under the EPC, e.g. the amendment must not introduce a lack of clarity into the claims (Art. 84); and
- (iii) it must comply with Rule 137(5) (see H-II, 6).

If the amendments do not meet these conditions, the applicant should be told that the amended application cannot be allowed. Apart from the amendments referred to in C-III, 2.1 and 2.2, which are admissible under Rule 137(2), the applicant may correct obvious errors at any time (see H-VI, 4.2.1).

If amendments are made and these are not identified and/or their basis in the application as filed not indicated by the applicant (see H-III, 2.1) and the application is one of those mentioned in H-III, 2.1.4, the Examining Division may send a communication according to Rule 137(4) requesting the applicant to provide this information (see H-III, 2.1.1).

### **2.1 Amendments made in response to the search opinion**

*Rule 137(2) and (3)*

The amendments referred to in C-II, 3.1 are made by the applicant "of his own volition" (the applicant is required to respond to the search opinion in the EESR, but does not necessarily have to respond by filing amendments; he can also respond by filing observations on the search opinion – see B-XI, 8). This means that the applicant is not restricted to amendment(s) necessary to remedy a defect in his application. Further amendments may be made only with the consent of the Examining Division (see H-II, 2.3).

### **2.2 Amendments made in response to the WO-ISA, IPER or supplementary international search report**

*Rule 137(2)*

For Euro-PCT applications where the EPO acted as International Searching Authority (ISA) or as the authority specified for supplementary international search (SISA), any amendments which the applicant files in response to the communication under Rule 161(1) (see E-VIII, 3.3.4) are made by the applicant of his own volition. This means that they may be submitted to overcome objections raised in the WO-ISA, IPER or supplementary international search report or they may be suggested for some other reason, e.g. to remedy some lack of clarity which the applicant himself has noted in the original



documents. In order to avoid delays, care should be taken to comply with the requirements of Rule 137(4) when filing such amendments. Furthermore, the applicant may also file observations in place of or in addition to amendments.

### **2.3 Searches under Rule 164(2)**

For Euro-PCT applications where the EPO acted as ISA or as SISA, the Examining Division under Rule 164(2) assesses the application documents upon expiry of the six-month time limit set in the communication under Rule 161 or 162. For any claimed invention or group of inventions within the meaning of Art. 82 which was not searched by the EPO in its capacity as ISA or SISA, the Examining Division issues an invitation to pay search fees.

*Rule 164(2)*

The application documents as amended may contain claims directed to a non-searched invention in situations other than where the application documents which are to serve as the basis for examination do not meet the requirement of unity of invention. For instance, the amended application may contain just one invention, but it may be an invention that was claimed but not searched by the EPO as (S)ISA in the international phase. It may well be that an invention in the application documents was not even claimed in the application documents that served as the basis for the procedure in the international phase and has been imported from the description (see F-V, 13.1(iv)). In such cases an invitation to pay search fees under Rule 164(2) for any non-searched invention is to be issued by the Examining Division.

The invitation under Rule 164(2) must be sent before any communication according to Art. 94(3). It is to be noted that for Rule 164(2) to apply, the claims must be sufficiently clear to allow the identification of a non-searched invention by which the procedure under Rule 164(2) is triggered. If the claims are so unclear that a non-searched invention cannot be identified, the first action must be issuance of a communication under Art. 94(3) setting out the objections under Art. 84. Should it turn out later in the procedure that amended claims are indeed directed to a non-searched invention, the applicant must file a divisional application for any such subject-matter. Recourse to Rule 164(2) is not provided for if, as a result of further amendments or clarification, (further) non-searched inventions are identified, since the procedure under Rule 164(2) applies to the application documents as submitted by the applicant as the basis for examination.

If auxiliary requests are submitted before a search under Rule 164(2) is performed, only the main request is taken into account for the purpose of the search (notwithstanding the exceptions relating to Rule 62a or 63 cases where main and auxiliary requests are both considered at the search stage, see B-VIII, 3.2.2 and 4.2.2).

If any search fee(s) is/are paid in time, the results of the search(es) are communicated to the applicant as an annex to a communication under Art. 94(3) and Rule 71(1) and (2) or under Rule 71(3), as set out in Rule 164(2)(b). This annex is entitled "Search result according to Rule 164(2)".

If search fees are not paid in due time under Rule 164(2), a communication under Art. 94(3) and Rule 71(1) and (2) or under Rule 71(3) will be issued and the Examining Division will require deletion of any non-searched subject-matter that was not searched either because a search fee under Rule 164(2) was not paid (see H-II, 7) or for a different reason (see H-II, 6).

The communication deals with all objections for each of the inventions searched in accordance with Rule 164(2) and also for all inventions searched by the EPO in the international phase, where these inventions persist in the claims. This communication, where appropriate, further requests the applicant to limit the application to a single searched invention (see Rule 164(2)(c)).

It follows from Rule 164(2)(b) and (c) that the special procedure under Rule 164(2) as set out in H-II, 2.3 ends upon expiry of the time limit set in the communication issued under paragraph (b). This means that the applicant's right to make amendments of his own volition ends upon expiry of the time limit set in that communication.

Furthermore, the special procedure as set out in F-V, 13.1(iv), which exempts amendments from the requirements of Rule 137(5), first sentence, ends upon expiry of the time limit under Rule 161(1). Such amendments will result in an invitation under Rule 164(2)(a) and allow the applicant to obtain a search of unsearched subject matter referred to in Rule 137(5). However, any amendments submitted after expiry of the time limit under Rule 161(1) are subject to the requirements of Rule 137(5), first sentence (see H-II, 6.2).

The EPO's obligations under Rule 164(2) are fulfilled and the applicant's rights under this Rule are exhausted once a single communication under Rule 164(2) has been sent. It follows that in cases of cascading non-unity no (further) invitation under Rule 164(2) is sent. The same applies if claims are added or existing claims amended so that they relate to non-searched inventions in the course of the examination procedure.

Exceptional cases may arise where the following sequence of events has occurred in the international phase:

- (i) The EPO acted as ISA in the international phase.
- (ii) The EPO acting as ISA invited the applicant to pay one or more additional international search fees in accordance with

Art. 17(3)(a) PCT and Rule 40 PCT (due to a lack of unity according to Rule 13 PCT).

- (iii) The applicant paid at least one such additional search fee.
- (iv) The additional search(es) led to a further objection as to a lack of unity a posteriori (a cascading lack of unity), resulting in one of the inventions identified in the invitation under Art. 17(3)(a) PCT and Rule 40 PCT being further sub-divided and resulting in sub-inventions not originally identified in that invitation.
- (v) The EPO did not search all such sub-inventions.

In the above case, the EPO will invite the applicant to pay search fees for any such unsearched sub-inventions in the claims which are to form the basis for examination on expiry of the six-month period under Rule 161(1), in accordance with Rule 164(2).

Where the EPO was the SISA in accordance with Rule 45bis.9 PCT, it may make a finding of a lack of unity of the international application according to Rule 45bis.6(a) PCT. However, in the procedure before the SISA, the applicant cannot pay additional supplementary international search fees, and the Supplementary International Search Report will be directed only to the invention or unitary group of inventions first mentioned in the claims (Rule 45bis.6(a) PCT). Where such an application contains unsearched inventions in the claims which are to form the basis for examination on expiry of the six-month period under Rule 161(1), a communication according to Rule 164(2) is issued, allowing the applicant to have these inventions searched upon payment of search fees and permitting him to pursue one of them in the examination proceedings.

Rule 164(2)(b) provides for a right to amend the application in response to the results of any search under Rule 164(2). This means that the applicant may make amendments of his own volition once in response to the communication under Art. 94(3) to which the search results under Rule 164(2) are annexed (H-II, 2.3).

### 3. Unity of invention

#### 3.1 Relation to unity in search; limitation to searched invention

An objection of lack of unity of invention, if applicable, should already have been raised at the search stage. If such an objection was not raised, but the Examining Division nevertheless considers that the requirements of Art. 82 are not met, the question of lack of unity will be addressed as early as possible during examination.

*Art. 82*

##### 3.1.1 No additional search fees paid

If the applicant has not availed himself of the opportunity to have the search results on the other inventions included in the search report because he has paid no additional search fees in response to the

*Rule 64*

*Rule 164(1) and (2)*

invitation under Rule 64(1) (see B-VII, 1.2) or Rule 164(1) (see B-VII, 2.3), he will be taken to have elected that the application should proceed on the basis of the invention which has been searched (see G 2/92). In cases where a communication according to Rule 164(2) has been sent, Rule 164(2)(c) requires the applicant to delete all unsearched inventions from the claims.

It must be taken into account that the final responsibility for establishing whether the application meets the requirement of unity of invention ultimately rests with the Examining Division (see T 631/97). When considering the issue of unity, the Examining Division will consider both the reasons given in the search opinion and the applicant's response thereto (see B-XI, 8 for details of when a response to the search opinion is required); for Euro-PCT cases where no supplementary European search report is prepared, the Examining Division will consider the reasons given in the WO-ISA, IPER or supplementary international search report prepared by the EPO and the applicant's response thereto as required by Rule 161(1) (see E-VIII, 3.2). In the absence of any convincing response from the applicant to the issue of unity as raised earlier, the Examining Division will normally initially uphold the position taken earlier (see B-XI, 1.2) and will then require deletion of all the inventions other than that which has been searched. If the Examining Division is convinced, e.g. by arguments from the applicant, that the opinion on unity at the search stage was incorrect, then an additional search is performed for that part of the subject-matter which is judged to be unitary with an invention which was searched (see B-II, 4.2(iii) and C-IV, 7.2) and the examination is carried out on those claims which comply with the requirement of unity of invention. The applicant may file a divisional application for any excised subject-matter (see C-III, 3.2).

### **3.1.2 Additional search fees paid**

If the applicant has taken the opportunity to have other inventions searched, then he may determine that the application is to proceed on the basis of any of these, the other(s) being deleted. If the applicant has not yet done so, the examiner should at the beginning of substantive examination, if he maintains the objection of lack of unity (see C-III, 3.1.1), invite the applicant to state on which invention the prosecution of the application should be based and to limit the application accordingly by excising those parts belonging to the other inventions. For the latter inventions, the applicant may file divisional applications (see C-III, 3.2).

### **3.2 Excision of other inventions; filing divisional applications**

For inventions which the applicant has deleted in accordance with C-III, 3.1.1 or 3.1.2, the applicant may file divisional applications.

The filing of a divisional application is only possible if the application being divided is still pending (see A-IV, 1.1.1).

### 3.3 Refund of additional search fees

If the applicant has paid further search fees in response to an invitation under Rule 64(1), 164(1) or (2) and has requested a refund of these, the Examining Division is required to review the validity of the finding of lack of unity (see also F-V, 10 to 13).

*Rule 64(2)*

*Rule 164(5)*

Requests for refunds should be handled promptly. If the examiner concludes that a request for refund should not be granted, an interlocutory decision to that effect should be issued at the earliest opportunity, subject to the requirements of Art. 113(1), and the issuing of the decision should not normally be left until the final decision on the application. Of course, if the stage in the procedure at which the examiner is in a position to issue the decision on the refund coincides with the issuing of either a Rule 71(3) communication or a decision refusing the application, then in the former case the interlocutory decision can be issued with the Rule 71(3) communication, and in the latter case the decision on the refund can be included in the decision refusing the application. An interlocutory decision issued on this matter will allow separate appeal under Art. 106(2).

Before an interlocutory decision is issued which refuses the request to refund additional search fees under Rule 64(2), the applicant should be informed of the Examining Division's preliminary opinion in a communication under Art. 94(3). The arguments presented by the applicant in his reply to the search opinion should be taken into account in this preliminary opinion. Furthermore, a time limit should be set in order to give the applicant the possibility to comment on the Examining Division's preliminary opinion. At the same time, the applicant can be informed that he may request an interlocutory decision on the refund which will allow separate appeal under Art. 106(2). If these requirements are fulfilled, the applicant's right to be heard under Art. 113(1) is respected. The same procedure applies to the refund of search fees paid under Rule 164(1) and (2).

Rule 164(5) provides for a refund of any search fee paid under Rule 164(1) or (2) in line with Rule 64(2) (see A-X, 10.2.2). Where the applicant pays a search fee in response to the Rule 164(2) invitation and at the same time contests the basis for requiring payment of a search fee and requests its refund under Rule 164(5), the Examining Division may deal directly with this issue in the communication according to Art. 94(3) and Rule 71(1) or (2) which accompanies the search results under Rule 164(2). Such an immediate review of the applicant's request is not possible in Rule 64(1) and 164(1) cases until such time as the Examining Division assumes responsibility for the application.

Moreover, it is essential to bear in mind that the review under Rule 64(2) or 164(5) is restricted to a reconsideration of the validity of that original finding under the circumstances existing at the time the Rule 64(1), 164(1) or (2) invitation was sent, taking into account only the prior art which was available at that time. For more details on the assessment of unity of invention see F-V.

The issue of refunds of additional **international** search fees paid to the EPO acting as ISA in response to an invitation under Art. 17(3)(a) PCT, however, does not arise in the European phase, because these fees were paid in the international phase, which is closed by this stage of the procedure. The applicant may contest the payment of additional international search fees to the EPO acting as ISA by paying these under protest according to Rule 40.2(c) PCT. However, this must be done in the **international** phase (see also the Decision of the President of the EPO dated 24 March 2010, OJ EPO 2010, 320 and the Notice from the EPO dated 24 March 2010, OJ EPO 2010, 322).

### 3.4 Changing from one searched invention to another

Having limited the claims to one searched invention, the applicant may not amend them to switch to a different searched invention (see G 2/92 and H-II, 7.1).

## 4. First communication

If deficiencies persist in the application even after the applicant has filed his response to the search opinion, the Examining Division will issue a communication according to Art. 94(3) and Rule 71(1), (2) in subsequent examination proceedings and will consider the applicant's reply thereto before issuing a negative decision or a summons to oral proceedings.

When drawing up such a communication, the Examining Division will take into account the documents (if any) cited in the search report and any further documents found as the result of the search referred to in C-IV, 7.1, as well as any amendments proposed, or comments made, by the applicant in reply to the search opinion (see B-XI, 8) or in reply to the communication under Rule 161(1) (see E-VIII, 3). The examiner should identify in this communication any requirements of the EPC which, in his opinion, the application does not satisfy. The communication will give reasons for any objections raised and will invite the applicant within a specified period to file his observations or submit amendments. The filed application documents are not sent back to the applicant although a copy of the description and claims may be sent in appropriate cases (see H-III, 2). When the applicant has replied, the examiner will then re-examine the application.

If no search opinion has been issued (see C-VI, 3, F-V, 13.1(ii) and B-XI, 1.1), the examiner's first communication under Art. 94(3) will, as a general rule (see B-XI, 3) and by analogy with the search opinion, cover all objections to the application (see B-XI, 3.4, for exceptional cases where not all objections are raised).

### 4.1 Reasoned objections

As with the search opinion, for each objection the communication should indicate the part of the application which is deficient and the requirement of the EPC which is not met, either by referring to specific Articles or Rules, or by other clear indication; it should also give the

*Rule 71(1) and (2)*  
*Rule 132*  
*Art. 94(3)*

*Rule 71(2)*

reason for any objection where this is not immediately apparent (for more details see B-XI, 3.2).

#### **4.2 Invitation to file comments and amendments**

The communication should include an invitation to the applicant to file his observations, to correct any deficiencies and, if necessary, to submit amendments to the description, claims and drawings. It must also state the period within which the applicant must reply. Failure to reply in due time will cause the application to be deemed withdrawn (see C-VI, 1 and E-VII, 1). Further processing applies to this loss of rights (E-VII, 2.1).

*Rule 71(1) and (2)*  
*Art. 94(3) and (4)*

#### **5. Requesting information on prior art (not confined to priority)**

The EPO may invite the applicant to submit, within a period of two months, information on prior art which has been taken into consideration in national or regional patent proceedings concerning an invention to which the European patent application relates. This in particular encompasses search results with respect to filings whose priority is not being claimed, and it also enables the EPO to request, *inter alia*, the copy of the results of the search on the priority or priorities referred to in Rule 141(1), where the search results were not available to the applicant when requested under Rule 70b(1) (see the Notice from the EPO dated 28 July 2010, OJ EPO 2010, 410). Failure on the part of the applicant to comply with this invitation results in the application being deemed to be withdrawn under Art. 124(2). Further processing is available for this loss of rights (see E-VII, 2.1).

*Art. 124*  
*Rule 141(3)*

In view of the considerable work such invitations may imply for applicants, further requests under Rule 141(3) will be issued only in individual cases, where there are cogent reasons to suspect the existence of additional, relevant prior art.

This invitation is an independent communication, and the above-mentioned time limit is non-extendable. The invitation can be sent by itself or at the same time as a communication according to Art. 94(3). If sent at the same time, the time limits set in both communications are independent of one another. Any information on prior art provided by the applicant will be included in the file and will be open to file inspection (see A-XI).

#### **6. Evaluation of prior art documents cited in search report and late priority claim**

As explained in A-III, 6.5.1 and 6.5.2, the applicant has the right to correct or to introduce a priority claim within 16 months of the earliest priority (with a minimum of four months from the European filing date in the case of corrections). When this happens before finalisation of the search report, the examiner may review the draft search report to take into account the change in the effective date of the application. In cases where the search report was issued on the basis of the original priority status (i.e. addition or correction of a priority claim is effected after the search report is drawn up), the primary examiner at the

substantive examination stage should re-evaluate the relevance of the documents cited in the search report. Where it appears that the prior art available to the examiner is unlikely to reflect the state of the art in a sufficiently complete way for the purpose of a patentability assessment, the examiner should then conduct an additional search (see C-IV, 7.2). No further search report will be issued in these cases: the applicant will be informed of any newly-found documents in a communication pursuant to Art. 94(3) (with copies of such documents annexed to that communication).



## Chapter IV – Examination of replies and further stages of examination

### 1. General procedure

Following the applicant's reply to the search opinion (see B-XI, 8), WO-ISA, IPER or supplementary international search report prepared by the EPO (see E-VIII, 3) or to the first communication, the examiner must examine the application, taking into account observations or amendments made by the applicant.

Where the application is one of those mentioned in H-III, 2.1.4, Rule 137(4) requires that any amendments made by the applicant in reply to the search opinion, WO-ISA, IPER or supplementary international search report be identified and their basis in the application as filed indicated. Failure to comply with this requirement may result in the Examining Division sending a communication according to Rule 137(4). For more details of the procedure, see H-III, 2.1.1 and 2.1.2.

In the case of one or more auxiliary request(s) directed to alternative texts for grant of a patent, every such request qualifies as a text submitted or agreed by the applicant within the meaning of Art. 113(2) and therefore must be dealt with in the order indicated or agreed to by the applicant, up to and including the highest-ranking allowable request, if any (see also H-III, 3 and C-V, 1.1). It is also to be noted that, for the types of application mentioned in H-III, 2.1.4, Rule 137(4) must also be complied with in respect of auxiliary requests, which may also be subject to a communication according to Rule 137(4).

### 2. Extent of examination of replies

After the first examination stage, provided that the:

- search opinion,
- WO-ISA (when prepared by the EPO),
- explanation accompanying the supplementary international search report under Rule 45*bis*.7(e) PCT (when prepared by the EPO, see the Notice from the EPO dated 24 March 2010, OJ EPO 2010, 316, point 6),
- IPER (when prepared by the EPO), or
- first communication (see B-XI, 1.1 and 8)

was comprehensive and clear (see B-XI, 3, and C-III, 4 and 4.1), the examiner will not normally need to completely reread the application but rather should concentrate on the amendments themselves, the related passages, and the deficiencies previously noted.

### 3. Further action upon examination of replies

*Art. 94(3)*

The examiner should be guided at this stage by the over-riding principle that a final position (grant or refusal) should be reached in as few actions as possible, and he should control the procedure with this always in mind. The EPC provides that the process of communicating with the applicant described in C-III, 4, is repeated "as often as necessary".

In most cases, the applicant will have tried to deal with all the examiner's objections (see B-XI, 8).

*Art. 113(1)*

If examination of the applicant's reply shows that despite his submissions objections persist, and provided that at least one communication has been sent in examination proceedings (see C-III, 4 and E-VIII, 4.1) and the applicant has been given the right to be heard (Art. 113(1)), i.e. the decision is based solely on grounds on which he has had an opportunity to comment, the application is to be refused (see T 201/98).

If examination of the applicant's reply shows that he has not dealt with all the main objections in his reply, it may be appropriate to draw the deficiencies to his attention, e.g. by telephone. But if no positive reaction is to be expected, the examiner should consider recommending to the other members of the Examining Division that the application be refused immediately (again provided that at least one communication has been sent in examination proceedings).

In most cases, however, examination of the applicant's reply will show that there are good prospects of bringing the proceedings to a positive conclusion, i.e. in the form of a decision to grant. In such cases, if there are still objections to be met, the examiner must consider whether they can best be resolved by a further written communication, a telephone discussion or a personal interview. If substantial differences of opinion exist, the issues are generally best dealt with in writing. If, however, there seems to be confusion about points in dispute, e.g. the applicant seems to have misunderstood the examiner's arguments or the applicant's own arguments are unclear, then an interview may be useful. If, on the other hand, the matters to be resolved are minor, they can be settled more expeditiously over the telephone. Interviews or telephone discussions with the applicant or his representative are more fully considered in C-VII, 2. Telephone discussions or interviews do not constitute oral proceedings (see E-II).

### 4. Later stages of examination

Similar considerations apply to later stages of examination on the understanding that, having regard to the principle stated in C-IV, 3, the greater the number of actions which have already taken place, the greater is the likelihood that the most appropriate action is to refer the application to the other members of the Examining Division for a decision. Where this decision is to refuse the application, particular

care should be taken to ensure that the decision does not offend against Art. 113(1).

#### **5. Examination of amendments**

Any amendment must satisfy the conditions listed in C-III, 2. When it was effected must also be established.

#### **6. Admissibility of amendments made by the applicant**

For matters relating to the admissibility of amendments made in examination proceedings see H-II, 2. *Rule 137(2) and (3)*

#### **7. Search-related issues in examination**

##### **7.1 Search for conflicting European applications**

The examiner should make a search for any additional conflicting European applications falling within the area defined by Art. 54(3), unless this was already covered by the search report.

This is because as a general rule the search files will not be complete in respect of such material at the time the main search is made. Since priority dates claimed (if any) may not be accorded to all or part of the application but may be accorded to the appropriate part of a conflicting application (see F-VI, 2.1), this search should be extended so as to cover all European applications published up to eighteen months after the filing of the application under consideration. On condition that the priority claim is valid for the whole content of the patent application under examination, the top-up search may exceptionally be performed at the earliest 18 months from the priority date. If the examiner is unable to complete this "topping-up" search at the time the search opinion or the first communication under Art. 94(3) is prepared, he should ensure that such search is completed before the application is reported to be in order for the grant of a patent. In the rare case in which the application is found to be in order before this search can be completed (e.g. due to a request for accelerated prosecution of an application not claiming priority, "PACE", see Notice from the EPO dated 4 May 2010, OJ EPO 2010, 352), the grant of a patent should be postponed until the topping-up search can be completed (T 1849/12).

In addition to retrieving Art. 54(3) documents which were not available at the time of the original search, the top-up search takes into consideration, *inter alia*, potentially relevant prior art cited by other Patent Offices on applications belonging to the same patent family as the application under examination at the EPO, and therefore needs to be performed for any file at the start and end of examination.

In the framework of the refund of examination fees (see A-VI, 2.5), the launch of a top-up search is triggered at the start of examination. This creates a marker which serves as evidence in the file that the Examining Division has started its substantive work.

## 7.2 Additional searches during examination

An additional search will sometimes be required either at the first stage of amendment or subsequently. This may arise for a number of reasons.

An additional search may be necessary:

- (i) where a declaration or a partial search taking the place of the search report under Rule 63 has been issued at the search stage after an invitation under Rule 63(1) (see B-VIII, 3, 3.1 and 3.2), and subsequently the deficiencies which rendered a meaningful search impossible under Rule 63 have been corrected by amendment complying with Rule 137(5) (see H-II, 6.1) or successfully refuted by the applicant;
- (ii) where the applicant successfully argues that a plurality of independent claims in the same category, which led to a limitation of the search report in accordance with Rule 62a (see B-VIII, 4.1 and 4.2), is in fact allowable according to the exceptions provided for in Rule 43(2) (see F-IV, 3.2);
- (iii) where a particular part of the application has not been searched because of an objection of lack of unity of invention, and the arguments put forward by the applicant have convinced the Examining Division that unity is given;
- (iv) where the claims have been so amended that their scope is no longer covered by the original search;
- (v) where a search report under Rule 61 was issued containing no prior art documents because the technical features were found to be notorious (see B-VIII, 2.2(ii)) and the Examining Division does not share this opinion;
- (vi) where no prior art document was cited for features which were considered to be part of the common general knowledge and the Examining Division does not share this opinion or the common general knowledge is challenged by the applicant (see G-VII, 2 and 3.1);
- (vii) exceptionally, where the applicant states that he made a mistake in the acknowledgement of prior art (see G-VII, 5.1) or the examiner believes that material relevant to obviousness might be found in technical fields not taken into account during the search;
- (viii) where the applicant has introduced a new priority claim after the date of filing (see C-III, 6).

*Art. 153(6) and (7)*

If the application has been filed under the PCT, the search report will be the international search report made under the PCT, which will be

accompanied by a supplementary European search report, unless the Administrative Council has decided that a supplementary report is to be dispensed with (see E-VIII, 3.2). Both of these reports will have to be considered by the examiner when deciding whether any additional search is required.

| For searches under Rule 164(2) see C-III, 2.3.

### **7.3 Search at the examination stage**

Although in principle all search work (other than for Art. 54(3) material) should be done at the search stage, in exceptional circumstances the examiner is not barred from looking for a relevant document whose existence he knows of or has reason to suspect, if he can retrieve that document in a short time.

### **7.4 Citing documents not mentioned in the search report**

A copy of any document cited by the examiner but not mentioned in the search report, for example one found in a search under C-IV, 7.1 or 7.2, should be sent to the applicant and identified in the electronic dossier (see the Decision of the President of the EPO dated 12 July 2007, Special edition No. 3, OJ EPO 2007, J.2).



## Chapter V – The final stage of examination

### 1. Communication under Rule 71(3)

#### 1.1 Text for approval

Once the Examining Division has decided that a patent can be granted it must inform the applicant of the text on the basis of which it intends to do so. This text may include amendments and corrections made by the Examining Division on its own initiative which it can reasonably expect the applicant to accept. In case of doubt as to whether the applicant would agree to the amendments proposed by the Examining Division, the applicant should be contacted by telephone or an official communication has to be written. The applicant's agreement to such amendments will usually be minuted in the communication according to Rule 71(3) (see C-VII, 2.5). *Rule 71(3)*

Examples of amendments where no such consultation with the applicant is required are the following:

- (a) bringing a statement of invention in the description into conformity with the claims
- (b) deletion of vague general statements in the description (see F-IV, 4.4) or of obviously irrelevant matter (see F-II, 7.4)
- (c) insertion of values in SI units (see F-II, 4.13)
- (d) insertion of reference numerals in claims, unless the applicant is known to object to this or has previously objected to this
- (e) introduction of a summary of background art which clearly represents the prior art closest to the invention
- (f) amendments which, in spite of the fact that they change the meaning or scope of an independent claim, would very clearly have to be made, so that it can be assumed that the applicant would not object to them
- (g) correction of linguistic and other minor errors
- (h) reformulation of method-of-treatment claims into an allowable format (see G-II, 4.2).

Examples of amendments which may not be proposed without consulting the applicant are:

- (a) amendments which significantly change the meaning or scope of the claims, if there are different ways of amending the claim, so that the examiner cannot assume to which possibility the applicant will agree.

- (b) deletion of entire claims, with the exception of so-called "omnibus claims" (i.e. claims reading "An apparatus substantially as described herein", or the like)
- (c) combining claims so as to overcome a novelty or inventive step objection.

With regard to such amendments and corrections made by the Division, it is important to bear in mind that the above list is designed to avoid changes which the applicant is more likely to reject, thus helping to avoid delays in the conclusion of examination proceedings. The standard marks used by the Division for indicating amendments and corrections using the electronic tool are listed in C-V, Annex.

The text is communicated to the applicant by despatching a communication under Rule 71(3), in which the applicant is furthermore invited to pay the fee for grant and publishing (see C-V, 1.2) and to file a translation of the claims in the two official languages of the EPO other than the language of the proceedings (see C-V, 1.3) within a period of four months, which is non-extendable. If the applicant pays the fees and files the translations within this period (and files or requests no corrections or amendments to the text proposed for grant in the Rule 71(3) communication, see C-V, 4.1), he will be deemed to have approved the text intended for grant (Rule 71(5)).

If during examination proceedings a main and auxiliary requests have been filed (see C-IV, 1 and E-IX, 3) and one of the requests is allowable, the communication pursuant to Rule 71(3) is to be issued on the basis of the (first) allowable request and must be accompanied by an explanation of the reasons why the higher-ranking requests are not allowable (see also H-III, 3).

Handwritten amendments by the applicant to the description, claims and abstract, unless they involve graphic symbols and characters and chemical or mathematical formulae, are no longer accepted in strict compliance with Rule 50(1) in conjunction with Rule 49(8) (see OJ EPO 2013, 603, and A-III, 3.2). For the procedure to follow in oral proceedings, see E-II, 8.7.

## **1.2 Grant and publishing fee**

The communication under Rule 71(3) also invites the applicant to pay the fee for grant and publishing within the same non-extendable four-month period. Note that for European patent applications filed before 1 April 2009 and international applications entering the regional phase before that date the fee for grant and printing may include an element depending on the number of pages, but for applications filed or entering the regional phase on or after that date this additional element is payable as part of the filing fee (see A-III, 13.2).



### 1.3 Translations of the claims

The communication under Rule 71(3) also invites the applicant to file a translation of the claims in the two official languages of the EPO other than the language of the proceedings within the same non-extendable four-month period.

If the application contains different sets of claims for particular Contracting States (see H-III, 4), a translation of all the sets of claims must be filed.

Only one copy of the translation need be filed.

The examiner should not concern himself with the quality of the translation filed.

The translation should meet the requirements pursuant to Rule 50(1). *Rule 50(1)*

### 1.4 Claims fees due in response to Rule 71(3) communication

If the text of the European patent application serving as the basis for grant contains more than fifteen claims, the Examining Division requests the applicant to pay, within the period under Rule 71(3), claims fees in respect of each claim over and above that number, unless he has already done so under Rule 45(1) or Rule 162(1) and (2) (see A-III, 9). Where there is more than one set of claims, fees are incurred under Rule 45(1), Rule 162(1) and 162(2) or Rule 71(4) only for the set with the greatest number of claims. *Rule 71(4)*  
*Rule 45(1)*  
*Rule 162(1) and (2)*

If the text on which the Rule 71(3) communication is based contains fewer claims than the set of claims in respect of which claims fees were paid on filing under Rule 45 or on entry into the European phase under Rule 162, no refund of claims fees will be made.

Where the communication under Rule 71(3) is based on an auxiliary request, it is the number of claims in that auxiliary request which determines the claims fees which are due in response to this communication. However, if the applicant then replies by requesting a grant based on a higher request, no claims fees need to be paid in response to that Rule 71(3) communication (see C-V, 4.1).

### 1.5 Other information in the communication under Rule 71(3)

An annex to the communication under Rule 71(3) states the Contracting States which have been validly designated, the title of the invention in the three EPO official languages, the international patent classification and the registered name of the applicant.

The communication under Rule 71(3) also states that, where a renewal fee falls due between the notification of this communication and the proposed date of publication of the mention of the grant, publication will be effected only after the renewal fee and any additional fee have been paid (see C-V, 2).

## 2. Grant of a patent

*Rule 71(5)*  
*Art. 97(1)*

If the applicant pays the fee for grant and publishing and any claims fees due under Rule 71(4) and files the translation of the claims within the specified period (and files or requests no corrections or amendments to the text proposed for grant in the Rule 71(3) communication, see C-V, 4.1), he is deemed to have approved the text intended for grant.

The above also applies where the Rule 71(3) communication was based on an auxiliary request, provided that the applicant does not reply to the Rule 71(3) communication by requesting that a grant be based on a higher request. This means that, in the absence of any indication to the contrary, the above acts imply approval of the text of the auxiliary request upon which the Rule 71(3) communication was based as well as the abandonment of all higher requests.

The above also applies where the Rule 71(3) communication included proposals by the Examining Division for amendments or corrections of the text intended for grant (see C-V, 1.1). Consequently, provided the applicant does not reject these proposed amendments or corrections in his reply, the completion of the above acts constitutes approval of the text containing the amendments or corrections as proposed by the Examining Division.

*Rule 71a(1)*

Once all the requirements set out in C-V, 1.1 to 1.4, are met, the decision to grant the European patent is issued, provided that renewal fees and any additional fees already due have been paid.

*Rule 71a(4)*  
*Art. 86(1)*

If a renewal fee becomes due after notification of the Rule 71(3) communication but before the next possible date for publication of the mention of the grant of the European patent, the decision to grant is not issued and the mention of the grant is not published until the renewal fee has been paid. The applicant is informed accordingly. If the renewal fee or any additional fee is not paid in time, the application is deemed to be withdrawn (see A-X, 5.2.4).

*Rule 71a(3)*

In the rare case that examination was accelerated to such an extent that the communication under Rule 71(3) is issued before the designation fee becomes due, the decision to grant will not be issued and the mention of the grant of the patent will not be published until the designation fee has been paid. The applicant is informed accordingly. For European patent applications filed before 1 April 2009 or international applications entering the regional phase before that date this publication will not take place until the designation fees have been paid and the designation of States for which no designation fees have been paid has been withdrawn (see also A-III, 11.1 and 11.3).

*Art. 97(3)*

The decision to grant does not take effect until the date on which the grant is mentioned in the European Patent Bulletin.

### **3. Application deemed withdrawn**

If the applicant fails to pay the fee for grant and publishing or the claims fees or to file the translation in due time, the application is deemed to be withdrawn unless, within the period under Rule 71(3), the applicant files or requests corrections or amendments to the text proposed for grant in the Rule 71(3) communication (see C-V, 4.1).

*Rule 71(7)*

### **4. Amendments or corrections filed in reply to a Rule 71(3) communication**

If the applicant, within the period under Rule 71(3), requests amendments or corrections to the communicated text which are reasoned (with regard to the reasoning required, see C-V, 4.3), the Examining Division will issue a new communication under Rule 71(3) if it gives its consent (i.e. if it finds the amendments admissible and allowable, see C-V, 4.6); otherwise it will resume the examination proceedings (see C-V, 4.7).

*Rule 71(6)*

In this and sections C-V, 4.1 to 4.10, unless otherwise stated, the terms "*amendment(s)*" and "*correction(s)*" refer only to amendments or corrections of the application documents and not of other documents (e.g. bibliographic data, the designation of the inventor, etc.).

#### **4.1 No payment of fees or filing of translations necessary**

In the case referred to in C-V, 4, the applicant will not be required to pay the fee for grant and publishing or any claims fees in reply to the first communication under Rule 71(3), nor will he be required to file any translations of the claims within this period. This applies irrespective of whether the Examining Division subsequently finds these amendments or corrections to be admissible and allowable and irrespective of whether the amendments or corrections are reasoned (see C-V, 4.3).

This also applies if the applicant requests the reversal of amendments proposed by the Examining Division in the Rule 71(3) communication (see C-V, 1.1). Furthermore, it also applies if the Rule 71(3) communication was based on an auxiliary request and the applicant replies by requesting that a grant be based on a higher request.

#### **4.2 Crediting of fees paid voluntarily**

Although the payment of fees in response to the Rule 71(3) communication is not required where the applicant files amendments or corrections in his response thereto (see C-V, 4.1), the applicant can still pay these fees voluntarily. If he does so, the amount of the fees paid will be credited to the payment of the same fees in response to a subsequent Rule 71(3) communication (issued either directly or after resumption of examination - see C-V, 4.6 and 4.7.2 respectively).

This crediting will be dealt with according to the procedures explained in A-X, 11. This is subject to the following: if the amount of the claims fees due in response to the second Rule 71(3) communication is less than the amount voluntarily paid in response to the first Rule 71(3) communication, a refund will be made of the excess paid, since the

higher claims fees were not due when paid in response to the first Rule 71(3) communication.

If, after such voluntary payment, the application is withdrawn, deemed to be withdrawn or refused, a refund of the voluntarily paid fee for grant and publishing will be possible under the conditions explained in A-X, 10.2.7. Furthermore, since the claims fees were paid when they were not due, these will also be refunded under the same conditions.

#### **4.3 Amendments or corrections should be reasoned**

The reasoning accompanying amendments or corrections filed in response to the Rule 71(3) communication should indicate respectively:

- why the applicant considers that the amended application documents comply with the EPC, in particular the requirements of patentability, Art. 123(2) and Art. 84;
- why the applicant considers that the errors and their proposed corrections are evident according to Rule 139.

If, within the period under Rule 71(3), the applicant files amendments or corrections which are **not** reasoned, no payment of the fee for grant and publishing or claims fees is necessary nor is the filing of translations (see C-V, 4.1). However, the lack of any reasoning means that such amendments or corrections are more likely to lead to a resumption of the examination procedure (see C-V, 4.7).

#### **4.4 Admissibility of amendments**

*Rule 137(3)*

The criteria for assessing the admissibility of such amendments are dealt with in detail in H-II, 2.5 and sub-sections.

By way of exception, in cases where the Rule 71(3) communication was also the first communication in examination proceedings, amendments filed in response thereto **must** be admitted into the proceedings under Rule 137 in cases (i) to (iii) mentioned in H-II, 2.2. However, where a **further** Rule 71(3) communication is sent in respect of such cases (see C-V, 4.6 and 4.7.2), any amendments filed in response thereto must be consented to by the Examining Division according to Rule 137(3) (see H-II, 2.5).

#### **4.5 Adaptation of the description**

If the amendments or corrections filed by the applicant in the Rule 71(3) period concern the claims, the applicant should consider whether this necessitates any adaptation of the description. In order to avoid potential delays in cases where adaptation is necessary, it is preferable for the applicant to provide an adapted description when filing amended claims in the Rule 71(3) period.

#### **4.6 Amendments/corrections admitted and allowable - second Rule 71(3) communication sent**

If the amendments and/or corrections filed within the period under Rule 71(3) are admitted under Rule 137(3) and also comply with the EPC, the Examining Division will send a second communication under Rule 71(3) based thereon.

*Rule 71(6)*

##### **4.6.1 Applicant rejects amendments proposed by Examining Division in first Rule 71(3) communication**

A second communication under Rule 71(3) is also sent if the applicant requests reversal of amendments proposed by the Examining Division in the first communication under Rule 71(3) and the Examining Division overturns its previous opinion, finding that the amendments that it had proposed were not necessary, possibly as a consequence of argumentation or evidence provided by the applicant in his reply to the first Rule 71(3) communication (in the absence of such convincing argumentation or evidence, examination will normally be resumed, see C-V, 4.7).

##### **4.6.2 Second Rule 71(3) invitation based on higher request initially rejected in first Rule 71(3) invitation**

In cases where the first Rule 71(3) communication was based on an auxiliary request (see H-III, 3, in particular H-III, 3.1 and 3.3 and sub-sections), the first communication under Rule 71(3) would have been accompanied by an explanation of why the higher requests were not considered to be allowable (see C-V, 1.1). If the applicant replies to this first Rule 71(3) communication indicating that he wishes a grant to be based on one of these higher requests which the Examining Division had previously held not to be allowable (see C-V, 1.1), such a request will normally lead to examination being resumed (see C-V, 4.7). The Examining Division may reverse its opinion, for example due to convincing argumentation or evidence filed by the applicant with his reply to the first Rule 71(3) communication. If the applicant is successful in this regard, the Examining Division will send a second communication under Rule 71(3) based on this higher request.

##### **4.6.3 Examining Division proposes amendments in second Rule 71(3) communication**

As with the first communication under Rule 71(3), the Examining Division may propose amendments to the applicant's latest request on which the second Rule 71(3) communication is based (this request includes amendments or corrections filed in response to the first Rule 71(3) communication). The types of amendment which may or may not be proposed by the Examining Division in the second Rule 71(3) communication are the same as those mentioned in C-V, 1.1. However, in the second communication under Rule 71(3), the Examining Division cannot re-propose amendments which were previously proposed and then rejected by the applicant. Where the Examining Division considers that such an amendment is necessary to

overcome an objection, it should consider resuming examination (see C-V, 4.7).

#### **4.7 Amendments not admitted and/or not allowable, examination resumed**

*Rule 71a(2)*

Until the decision to grant the European patent, the Examining Division may resume the examination proceedings at any time. This applies *inter alia* when the applicant files non-allowable or inadmissible amendments in response to the Rule 71(3) communication.

##### **4.7.1 Communications/oral proceedings after resumption**

*Art. 94(3)*

*Rule 71(1) and (2)*

Where the grounds or evidence behind the finding of non-allowability or inadmissibility of the amendments have not yet been dealt with in examination proceedings, before issuing a summons to oral proceedings or a decision to refuse (see C-V, 4.7.3) the Examining Division will send a communication according to Art. 94(3) and Rule 71(1) and (2) explaining this finding.

*Art. 116(1)*

If one of the following situations applies, the Examining Division will have to appoint oral proceedings before issuing a decision to refuse (see C-V, 4.7.3):

- (i) oral proceedings have been requested, but have not yet been held, or
- (ii) oral proceedings have been held, but:
  - the subject of the proceedings has changed such that a right to subsequent oral proceedings arises under Art. 116(1) (e.g. as a result of the amendments filed in response to the Rule 71(3) communication), and
  - the applicant has requested subsequent oral proceedings.

If the grounds and evidence behind the finding of non-allowability or inadmissibility of the amendments have been dealt with in examination proceedings, but not yet in oral proceedings, a summons to oral proceedings can be issued directly, provided at least one communication under Art. 94(3) and Rule 71(1) and (2) has been issued.

Requests for oral proceedings must be allowed as long as proceedings before the EPO are still pending, i.e. until the decision to grant has been handed over to the internal post (see G 12/91 and T 556/95, especially reasons for the decision 4.4).

If the following criteria are satisfied, the application may be refused directly: *Art. 97(2)*

- (i) the grounds and evidence behind the non-allowance or non-admittance of the request filed in response to the Rule 71(3) communication have already been dealt with in examination proceedings (Art. 113(1));
- (ii) the applicant has received at least one communication according to Art. 94(3) and Rule 71(1) and (2) (see C-III, 4); and
- (iii) the applicant's right to oral proceedings on request has been respected (Art. 116(1)).

#### **4.7.2 Agreement reached on a text - second Rule 71(3) communication**

If the resumption of examination described in C-V, 4.7.1, results in an allowable and admissible text being filed or results in the applicant convincing the Examining Division that the text already filed in response to the Rule 71(3) communication is in fact admissible and allowable, a second Rule 71(3) communication is sent based on this agreed text. Such cases are dealt with in the same way as described in C-V, 4.6. *Rule 71(6)*

#### **4.7.3 No agreement reached on a text - refusal**

If, after resumption of examination, no agreement can be reached on a text, the application is refused (see C-V, 14). For details on conducting the resumed examination proceedings before issuing this decision, see C-V, 4.7.1. *Art. 97(2)*

### **4.8 Fees to be paid within the second Rule 71(3) period**

Where the applicant files amendments or corrections in response to the first communication under Rule 71(3), he does not have to pay either the fee for grant and publishing or the claims fees (see C-V, 4.1). A second Rule 71(3) communication may then be issued either immediately (where the amended/corrected text is allowable - see C-V, 4.6) or after examination is resumed and an allowable text is agreed on (see C-V, 4.7.2).

#### **4.8.1 Claims fees**

In order for the text on which the second Rule 71(3) communication is based to be deemed approved according to Rule 71(5), it is necessary for the applicant to pay any claims fees which are due in response to the communication, thus also avoiding deemed withdrawal of the application under Rule 71(7) (for the calculation of claims fees due at this stage see C-V, 1.4).

Since no claims fees would normally have been paid in response to the first Rule 71(3) communication, the number of claims in the text on which this first communication was based plays no role in calculating the amount of the claims fees due in response to the second

Rule 71(3) communication. However, in cases where the applicant paid the claims fees voluntarily in response to the first Rule 71(3) communication, the amount paid is credited according to Rule 71a(5) (see C-V, 4.2 and A-X, 11.2).

#### **4.8.2 Fee for grant and publishing**

In order for the text on which the second Rule 71(3) communication is based to be deemed approved according to Rule 71(5), it is necessary for the applicant to pay the fee for grant and publishing in response to the communication, thus also avoiding deemed withdrawal of the application under Rule 71(7).

*Art. 2(2), No 7.2 RFees*

For European applications filed before 1 April 2009 or international applications entering the European phase before that date, the fee for grant and publishing incorporates a fee for each page of the application over and above 35 (see C-V, 1.2 and A-III, 13.2). If the number of pages of such an application changes between the first and the second Rule 71(3) communication, it is the number of pages on which the second Rule 71(3) communication is based which is used to calculate the amount of this fee. Where the applicant paid the fee voluntarily in response to the first Rule 71(3) communication, the amount paid will be credited according to Rule 71a(5) (see C-V, 4.2 and A-X, 11.1).

#### **4.9 Applicant disapproves of the text proposed for grant**

The applicant may reply to the communication under Rule 71(3) by simply disapproving of the text proposed therein and not paying any fees or filing the translations of the claims. In such cases, the application is not deemed to be withdrawn under Rule 71(7). Instead, if the following criteria are fulfilled, the application will be refused under Art. 97(2) for failure to comply with Art. 113(2), because there is no text agreed to by the applicant:

- (i) the Examining Division did not propose any amendments or corrections to the application in the communication under Rule 71(3),
- (ii) the Rule 71(3) communication was not based on an auxiliary request, and
- (iii) the applicant filed no amendments or corrections with his disapproval.

If the applicant has already been sent one communication in examination proceedings according to Art. 94(3) and Rule 71(1) and (2) (see C-III, 4 and E-VIII, 4.1) and his right to oral proceedings on request has been respected (Art. 116(1)), then the application can be refused directly without further communication with the applicant.

If criterion (i) is not met, the applicant's disapproval is interpreted as a rejection of the amendments or corrections proposed by the Examining Division in the Rule 71(3) communication. If criterion (ii) is not met, the



applicant's disapproval is interpreted as a request to base a grant on a higher request. If criterion (iii) is not met, the applicant's disapproval is interpreted as a desire to proceed with the application as amended or corrected by him in response to the Rule 71(3) communication. If any of these criteria are not met, either examination is re-opened as indicated in C-V, 4.7 or, if the applicant's submissions result in an allowable text, a second Rule 71(3) communication is sent (see C-V, 4.6). Where criterion (ii) is not met and it is not clear which higher request the applicant wishes to pursue, the Examining Division must request the applicant to clarify this in resumed examination proceedings.

#### **4.10 Amendments/corrections filed in second Rule 71(3) period**

In cases where a second Rule 71(3) communication is sent (see C-V, 4.6 and 4.7.2) and the applicant replies within this second Rule 71(3) period by doing one or more of the following, the procedures explained in C-V, 4.1 to 4.9 apply *mutatis mutandis*:

- (i) filing further amendments or corrections,
- (ii) rejecting amendments proposed by the Examining Division in the second Rule 71(3) communication, or
- (iii) reverting to a higher-ranking request (where the second Rule 71(3) communication is based on an auxiliary request).

In particular, in such cases the applicant will not be required to pay the fee for grant and publishing or any claims fees, nor will he be required to file translations of the claims within this second period under Rule 71(3). If the Examining Division agrees to a text (either with or without resumption of examination), a third communication under Rule 71(3) is then sent.

Furthermore, if the applicant replies to the second Rule 71(3) communication by rejecting amendments proposed by the Examining Division in the first Rule 71(3) communication (where these have not been superseded), the procedures described in C-V, 4.1 to 4.9 likewise apply *mutatis mutandis* (no need to pay fees or file translations etc).

#### **5. Further requests for amendment after approval**

The criteria for assessing the admissibility of such amendments are dealt with in detail in H-II, 2.6. The procedure for dealing with such late-filed amendments is explained in C-V, 6.

*Rule 137(3)*

## **6. The Examining Division resumes examination after approval of the text**

### **6.1 When does the Examining Division resume examination after approval?**

*Rule 71a(2)*

Subsequent to the applicant's approval in response to the Rule 71(3) communication (see C-V, 2), the Examining Division may resume the examination procedure at any time up to the moment the decision to grant is handed over to the EPO's internal postal service for transmittal to the applicant (see G 12/91). This will seldom occur, but may be necessary if e.g. the applicant files further prior art which necessitates further substantive examination, if the Examining Division becomes aware of very relevant prior art following observations by third parties under Art. 115, if the applicant files amendments or corrections (having already approved the text), or if the Examining Division becomes aware in some other way of circumstances which are such as to cause the subject-matter claimed to fail to comply with the EPC.

The resumption of examination after approval is subject to the same considerations as where examination is resumed due to amendments filed in the Rule 71(3) period (see C-V, 4.7.1). In particular, the applicant's right to comment (Art. 113(1)), his right to at least one communication under Art. 94(3) and Rule 71(1) and (2) in examination proceedings (see C-III, 4) and his right to oral proceedings on request (Art. 116(1)) must be respected.

*Rule 137(3)*

The criteria applied in assessing the admissibility of amendments or corrections filed by the applicant after approval are dealt with in H-II, 2.6.

### **6.2 A further communication under Rule 71(3)**

*Rule 71(6)*

A second Rule 71(3) communication is sent out if the resumed examination results in a text on the basis of which a patent can be granted (substantive amendments directed to resolving the issues which gave rise to the resumption of examination are possible).

### **6.3 Crediting of fees under Rule 71a(5)**

*Rule 71a(5)*

If, in response to an invitation under Rule 71(3), the applicant has already paid the fee for grant and publishing or the claims fees, the amount paid shall be credited if a further such invitation is issued. For more details on this procedure, see A-X, 11.

## **7. Correction of errors in the decision to grant**

Under certain circumstances, a decision to grant a European patent may be corrected. For more details see H-VI, 5.

## 8. Further processing

If the applicant overruns the time limit set under Rule 71(3), he may request further processing under Art. 121 (see E-VII, 2.1). The omitted act in respect of this further processing request is either: *Art. 121*

- (i) completion of all of the following acts referred to in Rule 71(3) and (4):
  - (a) payment of the fee for grant and publishing,
  - (b) payment of any claims fees due, and
  - (c) filing of the translations of the claims; or
- (ii) completion of one or more of the following acts:
  - (a) filing amendments and/or corrections to the application documents,
  - (b) rejecting amendments proposed by the Examining Division in the communication under Rule 71(3), or
  - (c) requesting a grant to be based on a higher request with respect to the auxiliary request on which the Rule 71(3) communication was based.

## 9. Refund of the fee for grant and publishing

If the application is refused, withdrawn prior to notification of the decision on the grant of a European patent or, at that time, deemed to be withdrawn, the fee for grant and publishing shall be refunded (for more details see A-X, 10.2.7). *Rule 71a(6)*

## 10. Publication of the patent specification

The decision to grant contains the date of the mention of the grant of the European patent and is sent to the applicant when the technical preparations for printing the patent specification have been completed.

As soon as possible after the mention of the grant is published in the Bulletin, the EPO publishes the patent specification containing the description, claims (in the three official languages) and any drawings. The front page of the published specification shows *inter alia* the Contracting States which are still designated at the time of grant (or the designation of which has been withdrawn after completion of the technical preparations for printing). With regard to the form in which the publication takes place, see the Decision of the President of the EPO dated 12 July 2007, Special edition No. 3, OJ EPO 2007, D.3. *Art. 98*  
*Rule 73*  
*Art. 14(6)*

Mistakes in the specification of a European patent arising in the course of its production have no effect on the content of the patent granted. For this, only the text on which the decision to grant the patent is based is decisive (see H-VI, 3). If necessary, the Office may arrange for

correction to be made public as soon as any mistake in a specification is discovered. This is done by means of a note in the European Patent Bulletin and publication of a corrigendum, the sole purpose being to bring the specification into line with the content of the decision to grant (see Rule 143(2) and the Decision of the President of the EPO dated 14 October 2009, OJ EPO 2009, 598, Art. 1, point 2).

### 11. Withdrawal before publication of the patent specification

*Rule 73*

The specification of the European patent is not published if the application is withdrawn before termination of the technical preparations for publication. If after termination of the technical preparations the application is withdrawn to avoid publication, non-publication cannot be guaranteed. The EPO will, however, try (in accordance with the principles of J 5/81) to prevent publication on a case-by-case basis if the stage reached in the publication procedure permits this reasonably easily. The application may be withdrawn by means of a signed declaration, which should be unqualified and unambiguous (see J 11/80). The applicant is bound by an effective declaration of withdrawal (see J 25/03, J 4/97; and J 10/87).

### 12. Certificate

*Rule 74*

As soon as the European patent specification has been published, the EPO issues the proprietor with a certificate attesting that the European patent has been granted to the person named in the certificate. Where there is more than one proprietor, each of them is issued with a certificate. The proprietor may request that a certified copy of the certificate with the specification attached be supplied to him upon payment of an administrative fee. For further details see the Decision of the President of the EPO dated 16 July 2013, OJ EPO 2013, 416.

### 13. European Patent Bulletin

*Art. 129(a)*

If no notice of opposition is recorded in the dossier of the European patent within nine months of publication of the mention of grant, the patent proprietor is informed and an appropriate entry is published in the European Patent Bulletin (point 1, Art. 1, Decision of the President of the EPO dated 14 October 2009, OJ EPO 2009, 598). If, subsequently, it emerges that an opposition was filed in time, the proprietor is again informed and a correction is published in the Bulletin.

### 14. Refusal

*Art. 97(2)*

*Art. 113(1)*

*Rule 111*

*Art. 109*

*Art. 111(1) and (2)*

If, despite the applicant's submissions, i.e. amendments or counter-arguments, objections persist after the applicant's reply to the first communication under Art. 94(3) in examination, then even at this stage a refusal can be issued (subject to oral proceedings being held, if these are requested). In the event that refusal is contemplated at this or any later stage of examination proceedings, the examiner should bring the application before the other members of the Examining Division, which may then decide to refuse the application. In any event, at some stage, the primary examiner will consult the other members of the Examining Division with a view to establishing whether the

application should be refused or a patent should be granted. If the Division intends to refuse the application, a written reasoned decision is necessary and this will normally be prepared by the primary examiner (see E-IX, 4 and 5). In preparing the decision, the examiner must take care to abide by the general principles set out in Art. 113(1), i.e. the decision must be based on grounds or evidence on which the applicant has had the opportunity to comment (see E-IX, 1.1 and 1.2).

In addition, the applicant's attention must be directed to the provisions for appeal laid down in Art. 106 to 108. If oral proceedings take place (see E-II), the decision may be given orally but must subsequently be notified in writing, the time limit for appeal then running from the date of such notification.

If the applicant appeals against the decision and the Examining Division considers, in the light of the applicant's statement, that the appeal is admissible and well-founded, it should rectify its decision accordingly within three months after receipt of the statement of grounds. Otherwise, the appeal will be considered by a Board of Appeal. If a decision to refuse a patent is reversed on appeal, the application may be referred back to the Examining Division for further examination. In such a case, the further examination will normally be entrusted to the examiner who performed the original examination. The Examining Division is bound by the *ratio decidendi* of the Board of Appeal, insofar as the facts are the same.

## **15. Decision according to the state of the file**

A special case is where the applicant does not file comments or amendments in reply to the examiner's communication but requests a decision "according to the state of the file" or "on the file as it stands", meaning that the applicant wishes to close the debate and a decision is taken on the basis of the current status of the application and any supporting arguments. The decision, which may be appealed, may only be based on grounds and evidence on which the applicant has had an opportunity to present his comments (Art. 113(1)).

### **15.1 The request for a decision according to the state of the file**

An applicant may file a request for a decision according to the state of the file at any stage during examination proceedings, provided that at least one communication in examination has been sent (see also C-V, 15.4). The request should be explicit and unambiguous, preferably using the wording "according to the state of the file" or "on the file as it stands".

If the request is not clear in this respect, the examiner should solve the ambiguity with an enquiry to the applicant.

A request for a decision according to the state of the file does not imply the withdrawal of a pending request for oral proceedings. Consequently, when filing a request for such a decision, it is recommended that the applicant also withdraws any pending request

for oral proceedings (conditional or otherwise). If the applicant does not do so, the examiner will request him to clarify in writing that he withdraws his request for oral proceedings before a decision according to the state of the file can be issued.

### **15.2 Decision by means of a standard form**

The examiner may be in a position to refuse the application using a standard form referring to the previous communication. In order to comply with the requirement that such a decision be reasoned (Rule 111(2)), this is only possible where the previous communication properly identifies the application documents on file and is well-reasoned and complete with respect to the grounds and the reasons for the refusal of the current request. A further condition is that no new arguments or amendments have been submitted by the applicant since the previous communication.

Although it is possible by way of exception to refer to more than one communication in the standard form, the examiner should carefully consider the requirements of Rule 111(2). In particular, if the different communications deal with different sets of claims, such that it is not clear which of the reasons given by the Examining Division in its communications might be essential to the decision to refuse, a fully reasoned decision should be issued instead (see C-V, 15.3).

### **15.3 Issuing a self-contained decision**

If the conditions set out in C-V, 15.2 are not met, it is necessary to issue a self-contained decision to refuse in order to comply with Rule 111(2). This is necessary, for example, where the numerous objections raised in the previous communications with respect to different sets of claims render unclear the grounds and the reasons for the refusal. This also applies if the applicant has made further submissions (including amendments) since the previous communication, where these do not cause the subsequent decision to be based on grounds or evidence on which the applicant has not had the opportunity to present his comments. In all cases, the requirements of Art. 113(1) should be carefully considered (see also E-IX, 1).

### **15.4 Issuing a further communication (no refusal)**

If it appears that the previous communications were insufficiently reasoned or incomplete, or if the applicant has filed amendments and/or arguments since the previous communication, the examiner should carefully consider Art. 113(1) and Rule 111(2) before issuing a refusal (see E-IX, 1). A further communication may have to be issued with sufficient reasoning, unless oral proceedings are to be held (see E-II, 2), in which case the reasoning would be given in the summons (Rule 116(1)). In the communication or summons the applicant should be informed that his request for a decision according to the state of the file could not be followed.



## **Annex**

### **Standard marks for indicating amendments or corrections by the Divisions**



#### **1. Insertion of letters and words**

Any insertion to the text made using the electronic tool is made in-line. No marks need to be put separately in the margins, top or bottom of the page.

In the produced PDF of the “working copy” of the “Druckexemplar”, the tool will insert amendment bars to the right of amendments and indicate amended pages as such. The tool also adds a pair of insertion signs that mark the beginning and end of each in-line insertion:

Mark	Explanation
	Denotes the beginning of text inserted
	Denotes the end of text inserted

“No break”, “line break” or “paragraph break” signs precede and succeed the signs above to indicate whether the inserted text should be kept in the same line or a new line or a paragraph should start before or after the inserted text:

Mark	Explanation
	No breaks: inserted text is kept on the same line (this is the default)
	Line break: starts a new line (must be set if needed)
	Paragraph break: starts a new paragraph (must be set if needed)

In case of inserting an entire newly-filed page, e.g. a page numbered “1a”, the construct [insert page 1a] is used.





## Chapter VI – Time limits and acceleration of examination

### 1. Time limits for response to communications from the examiner

#### 1.1 General considerations

The general considerations relating to time limits are set out in E-VII. The time limit for response to a communication from the examiner should in general be between two and four months in accordance with Rule 132. The period to be allowed will be determined by the examiner taking all the factors relevant to the particular application into account. These include the language normally used by the applicant or his representative; the number and nature of the objections raised; the length and technical complexity of the application; the proximity of the EPO to the applicant or, if he has one, his representative; and the distance separating applicant and representative.

This time limit can be extended if the applicant so requests before it expires (see E-VII, 1.6). Failure to respond to a communication according to Art. 94(3) and Rule 71(1) and (2) in time results in the application being deemed to be withdrawn. This loss of rights is subject to further processing (see E-VII, 2.1).

*Art. 94(1) and (4)  
Rule 132*

#### 1.2 Special circumstances

In certain special circumstances the examiner may allow up to six months for the time limit. The six-month period may be appropriate, for instance, if the applicant resides a long way from his representative and the language of the proceedings is not one to which the applicant is accustomed; or if the subject-matter of the application or the objections raised are exceptionally complicated (for more information see E-VII, 1.2).

The search opinion is not a communication under Art. 94(3).

### 2. Influencing the speed of examination proceedings - PACE

With a written request for accelerated examination under the programme for accelerated prosecution of European patent applications (PACE), the applicant can speed up the proceedings at the examination stage (see Notice from the EPO dated 4 May 2010, OJ EPO 2010, 352, and E-VII, 3.2).

### 3. Further ways to accelerate examination

Where the applicant files a request for examination before the search report is transmitted to him, he may also dispense with the need to comply with the invitation pursuant to Rule 70(2), and file a categorical request for examination whatever the result of the search may be, by which the procedure can also be accelerated (see Notice from the EPO dated 4 May 2010, OJ EPO 2010, 352). In this case, confirmation that he desires to proceed further with his application is deemed to be given

*Rule 70(2)  
Art. 11(b) RFees  
Rule 62(1)*

when the search report is transmitted to him, so that in accordance with Rule 62(1) the search report is not accompanied by a search opinion. Under these circumstances, if the application is not in order for grant, a communication under Art. 94(3) and Rule 71(1) and (2) is transmitted to the applicant. If the application is in order for grant, the subsequent procedure will depend on whether or not it is possible at that time to carry out the search for conflicting European applications according to Art. 54(3) (see C-IV, 7.1 and B-XI, 7). If that search can be carried out, and assuming that it does not identify any conflicting applications, then the communication under Rule 71(3) is transmitted to the applicant. If it cannot yet be carried out, then the communication from the examining division will be postponed until the said search is completed and the applicant will be informed accordingly. If the European patent application is subsequently withdrawn before the substantive examination has begun, 75% of the examination fee will be refunded (for more details see A-VI, 2.5).

The applicant can also accelerate the processing of Euro-PCT applications by waiving his right to the communications under Rule 161 and Rule 162 (see E-VIII, 3.1).

## Chapter VII – Other procedures in examination

### 1. General remark

In this Chapter the term "applicant" is intended to mean "representative" where he has appointed one. Where the applicant has appointed a representative, the procedures described in this Chapter should be conducted with that representative.

### 2. Telephone conversation, personal interview, e-mail

#### 2.1 Request for an interview; arranging an interview

The circumstances in which it may be appropriate for the examiner to communicate with the applicant by telephone or propose an interview rather than send a further written action are considered in C-IV, 3. If the applicant requests an interview, the request should be granted unless the examiner believes that no useful purpose would be served by such a discussion. With regard to the issue of telephone conversations and personal interviews in response to the EESR, before the application has entered the examination phase, see B-XI, 8.

When an interview is arranged, whether by telephone, by e-mail or in writing, and whether by the examiner or the applicant, the matters for discussion should be stated. If the arrangement is made by telephone, the examiner should record the particulars and briefly indicate, in the file, the matters to be discussed.

#### 2.2 Persons attending the interview

The interviewee must be a person entitled to act for the applicant before the EPO. If the applicant is a natural or legal person having his residence or place of business in a contracting state, interviews may only be conducted with:

- (a) the applicant (see A-VIII, 1.1),
- (b) a professional representative (see A-VIII, 1.1) or
- (c) a duly authorised employee of the applicant (see A-VIII, 1.2) or, to the extent defined in Art. 134(8), a legal practitioner (see A-VIII, 1.4).

Regarding (c), see also A-VIII, 1.5.

If the applicant is a natural or legal person having neither residence nor place of business in a contracting state, interviews may only be conducted with:

- a professional representative (see A-VIII, 1.1) or
- a legal practitioner (see A-VIII, 1.4 and 1.5).

Unless he is already known personally to the examiner conducting the interview, the person taking part in the interview must produce an official identity document.

The person entitled to act before the EPO, i.e. one of the persons listed above, may be accompanied by other persons, whose identity does not need to be checked. On request of the person entitled to act, such other persons may be allowed to take part in the interview if their participation is relevant to the proceedings.

From the Examining Division, only the examiner dealing with the case will normally be present. However, there is no objection to one or even both of the other members of the Examining Division participating in the interview.

However, the applicant or representative does not have the right to demand that additional members of the Examining Division be present. If a request is made for an interview with all three members, it will usually be advisable to appoint oral proceedings instead.

### **2.3 Conduct of an interview or telephone conversation**

The interview will normally be conducted solely by the examiner dealing with the application. It is not a formal procedure (for formal oral proceedings before the Examining Division, see E-II), and the minuting of the interview depends upon the nature of the matters under discussion (see C-VII, 2.5). It should always be made clear to the applicant that any agreement reached must ultimately be subject to the views of the other members of the Examining Division.

If a fresh objection of substance is raised at an interview and no amendment to meet it is agreed at the time, the objection must be confirmed by a communication of the minutes thereof, giving the applicant a fresh period within which to reply.

When the telephone is used to settle outstanding matters, the normal procedure should be for the examiner to telephone the applicant stating the number of the application he wishes to discuss and requesting the applicant to telephone back at a specified time. A note must be made in the minutes, giving particulars and identifying the matters discussed and any agreements reached. Any matters on which agreement was not reached should also be noted and the arguments adduced by the applicant should be summarised.

### **2.4 Effect of statements made in an interview or by telephone**

Oral statements made by telephone or at an interview must be confirmed in writing in order to be procedurally effective. Indeed, such statements are not normally legally binding. Such a statement cannot, for instance, be effective to meet a time limit (see, however, C-VII, 2.5). For the purpose of the European grant procedure, except in oral proceedings, only written statements are effective and only from the date on which they are received by the Office. Where appropriate, the

applicant/representative should therefore be advised to submit his observations or amendments in writing.

For the use of e-mail where the interview before the Examining Division is held as a video-conference, see C-VII, 2.6.

## **2.5 Minutes of an interview or telephone conversation**

Where the interview is concerned with the clarification of obscurities, the resolution of uncertainties, or putting the application in order by clearing up a number of minor points it will usually be sufficient if the examiner makes a note in the minutes of the matters discussed and the conclusions reached or amendments agreed. If, however, the interview is concerned with resolving weightier matters, such as questions of novelty, inventive step, unity or whether the amendment introduces fresh subject-matter, then a fuller note of the matters discussed should be made in the minutes (see below).

The minutes should list the participants, summarise the main results and state any oral requests. They must be signed by the examiner. Documents filed during a personal interview, such as new claims or an amended description, must be listed in the minutes and signed by the applicant/representative.

With regard to weightier matters which are discussed, it should always be the aim when drafting the minutes to specify in concrete terms the topics discussed, together with any amendments agreed, any opposing views, the reasons for any change of opinion and any conclusions drawn, unless these are clear from other documents in the dossier. In particular, the reasons for any amendments required by the examiner should be clearly indicated.

The use of indefinite, ambiguous or universally applicable statements in minutes should be avoided. For example, statements such as "Amendments to the claims were proposed to take account of the prior art cited in the search report" are of no assistance to members of the public, other members of the Division, or indeed the primary examiner himself at later stages of the procedure. The same applies to conclusions worded in a generalised manner.

In every case the minutes of an interview or telephone consultation should be placed in the dossier and a copy communicated to the applicant or his representative to notify him, even where a telephone consultation merely changes/confirms/cancels the time/date of a proposed interview. However, by way of exception, telephone consultations relating to amendments agreed immediately preceding completion of the communication according to Rule 71(3) may be minuted in that communication, provided that there is no uncertainty for the public as to what was agreed. The amendments must be identified as exactly as possible.

The minutes of interviews or telephone conversations should always indicate whether the next action is due to come from the applicant or the examiner. The minutes when dispatched to the applicant may:

- (i) be dispatched for information only, in which case if a time limit is still running, it should be observed; if no time limit is running, no action is required from the applicant;
- (ii) be dispatched such as to extend a running time limit, in which case the applicant must reply within that extended time limit, or
- (iii) be dispatched such as to set a new time limit for response, in which case the applicant must reply within this new time limit.

However, a time limit may only be set in connection with the dispatch of minutes of an interview or telephone consultation if a communication from the Examining Division has been issued. Otherwise the minutes must be sent as an annex to a first communication according to Art. 94(3).

## **2.6 Use of e-mail**

At present, e-mail has no legal force in proceedings under the EPC and thus cannot be used to validly perform any procedural act and, in particular, cannot be used to comply with time limits (see OJ EPO 2000, 458 and A-VIII, 2.5, in connection with Rule 2 and Rule 127).

As an exception, documents filed subsequently as referred to in Rule 50 (other than authorisations) may be filed by e-mail where interviews and oral proceedings before the Examining Division are held as a video-conference (for details, in particular on signature and format of attachments, see the Decision of the President of the EPO dated 20 April 2012, OJ EPO 2012, 348, and E-II, 11.3.2).

The above OJ notice and decision of the President also stress the importance of ensuring that any exchange of information is duly documented on file and that confidentiality issues should be carefully considered.

### **2.6.1 Examples of where e-mail could be used**

Typical examples where e-mail could be useful are:

- (i) arranging a date for an interview
- (ii) if during a telephone consultation particular amendments to claims are being discussed the applicant might want to communicate these immediately, i.e. during the consultation to the examiner for easier discussion
- (iii) shortly before oral proceedings: sending an electronic copy of amended claims in addition to the official submission made e.g.

by fax; this would ensure that the examining division gets the documents well in time for preparation of the oral proceedings

- (iv) during interviews and oral proceedings held as a video-conference: submitting further documents as referred to in Rule 50, including amended application documents (for details, see E-II, 11.3.2).

E-mails cannot replace an official communication under Art. 94(3).

### **2.6.2 Initiation of e-mail**

Neither the examiner nor the applicant should use e-mail without having previously agreed to this, e.g. during a telephone consultation. There must be mutual agreement between the examiner and the applicant to such use. Furthermore, the mere fact that an e-mail address is indicated on a letter head does not mean that the examiner can simply use such an e-mail address for file-related topics.

If, on the other hand, an examiner receives an e-mail from an applicant concerning procedural requests or addressing any substantive issues without previous agreement, such an e-mail cannot simply be ignored but must be dealt with, ensuring that the content is put in the official file (see also T 599/06); it is recommended that such an e-mail be replied to with the clear message that e-mail is not an official means of communication and that any requests should be filed by permitted means (see A-II, 1.1, 1.2 and 1.3). See however C-VII, 2.6, and E-II, 11.3.2, for the use of e-mail during an interview or oral proceedings held as a video-conference.

### **2.6.3 Confidentiality**

For non-published applications, confidentiality issues should be carefully considered and substantive matters should not form part of any e-mail correspondence concerning such applications.

### **2.6.4 Filing of amended documents and new requests**

As stated above, e-mail cannot be used to perform procedural acts (except, under certain conditions, during oral proceedings or interviews held as a video-conference; see C-VII, 2.6, and E-II, 11.3.2). If, e.g. shortly before oral proceedings, the applicant would like to submit new requests and/or amended documents, this should be done by fax, since only this ensures that the filed documents are given a valid date of receipt and form part of the file. Experience has shown that faxes are normally visible in the electronic file on the same day. As stated in C-VII, 2.6.1(iii), an informal copy, in addition to the fax, can be sent to the examiner for the convenience of the Division if this is felt necessary due to the short time frame.

### **2.6.5 Inclusion in the file of any e-mail exchange**

If e-mail is used, it is essential to ensure that the exchange of e-mails is properly documented in the file. This should be done by minuting the e-mail exchange (including data relating to addressee and date) and

sending this to the applicant for information with no time limit. This ensures that the exchange is included in the public part of the file and that the applicant is aware of this.

Submissions filed by e-mail during an interview or oral proceedings held as a video-conference, including all attachments, should be printed and annexed to the minutes of the oral proceedings (see E-II, 11.3.2, for details).

### **3. Taking of evidence**

#### **3.1 General remark**

The general considerations relating to the taking of evidence are set out in E-III. This section deals only with the kind of evidence most likely to arise in pre-grant proceedings, viz. written evidence.

#### **3.2 Producing evidence**

An Examining Division would not, as a general rule, require evidence to be produced. The primary function of the examiner in proceedings before grant is to point out to the applicant any ways in which the application does not meet the requirements of the EPC. If the applicant does not accept the view of the examiner, then it is for the applicant to decide whether he wishes to produce evidence in support of his case and, if so, what form that evidence should take. The Examining Division should afford the applicant a reasonable opportunity of producing any evidence which is likely to be relevant.

However, this opportunity should not be given where the Examining Division is convinced that no useful purpose would be served by it, or that undue delay would result.

#### **3.3 Written evidence**

Written evidence could include the supply of information, or the production of a document or of a sworn statement. To take some examples:

To rebut an allegation by the examiner of lack of inventive step, the applicant might supply information as to the technical advantages of the invention. Again he might produce a sworn statement, either from himself or from an independent witness, purporting to show that workers in the art have been trying for a long time unsuccessfully to solve the problem with which the invention is concerned, or that the invention is a completely new departure in the relevant art.

### **4. Oral proceedings**

The general considerations relating to oral proceedings are set out in E-II.

### **5. Examination of observations by third parties**

The general considerations relating to observations from third parties are set out in E-V, 3.



## Chapter VIII – Work within the Examining Division

### 1. General remarks

An Examining Division will normally consist of three technical examiners. However, within the Examining Division made responsible for the application, one member (the primary examiner) will, as a general rule, be entrusted to carry out all the work up to the point of a decision to grant a patent or refuse the application. This means that this examiner is entrusted to act on behalf of the Examining Division in all communications with the applicant up to that point, but he may confer informally with the other members of the Division at any time if a special point of doubt or difficulty arises. Where reference is made in this Part C of the Guidelines to the "examiner", this normally means the primary examiner, and it should be understood that this primary examiner is always acting in the name of the Examining Division. This examiner is normally the examiner who drafted the search report.

*Art. 18(2)*

As stated above, the examiner may seek the advice of other members of the Examining Division, if necessary, at any stage in the examination. However, a point will be reached when it becomes appropriate for the examiner to refer the case formally to the other members of the Examining Division. This will arise if he considers the case is in order to proceed to grant or, alternatively, where there seems no possibility of amendment which would overcome his objections or where the applicant has not overcome these objections, and the examiner considers the case is in order to proceed to refusal. There are also other circumstances in which reference to the Examining Division is appropriate, e.g. oral proceedings may be suggested by the examiner or requested by the applicant because an impasse has been reached. In considering whether to refer the application to the Division, the examiner should be guided by the principle stated in C-IV, 3.

The primary examiner should also bear in mind that when he issues a communication he does so in the name of the Division, and applicants are entitled to assume that if the examiner had doubts as to the views of the rest of the Division he would have discussed the matter with them beforehand.

As soon as the application has passed to the Examining Division under Rule 10, that Division will have ultimate responsibility, but formal matters will normally be dealt with by a formalities officer (see the Decision of the President of the EPO dated 12 December 2013, OJ EPO 2014, A6). The examiner should not spend time checking the work done by the Receiving Section or the formalities officer, but if he believes a formalities report is incorrect or incomplete he should refer the application to the formalities officer for further consideration.



## **2. Recommendation to grant**

If the examiner considers that the application satisfies the requirements of the EPC and is thus in order to proceed to grant, he should make a brief written report (the "votum"). As a general rule, it will be appropriate in this report for the examiner to give the reasons why, in his opinion, the subject-matter as claimed in the application is not obvious having regard to the state of the art. He should normally comment on the document reflecting the nearest prior art and the features of the claimed invention which make it patentable, although there may be exceptional circumstances where this is not necessary, e.g. where patentability is based on a surprising effect. He should also indicate how any apparently obscure but important points have ultimately been clarified, and if there are any borderline questions which the examiner has resolved in favour of the applicant he should draw attention specifically to these.

## **3. Recommendation to refuse**

When referring to the Examining Division an application which is not in order for grant of a patent, the examiner should confer with the other members of the Division, bringing to their attention the points at issue, summarising the case history to the extent necessary to enable the other members to obtain a quick grasp of the essential facts, and recommending the action to be taken, e.g. refusal, or grant conditional upon certain further amendments. As the other members will need to study the case themselves, there is no need for a detailed exposition. It will be useful, however, to draw attention to any unusual features or to points not readily apparent from the documents themselves. If the examiner recommends refusal and the issue seems clear-cut, he may already provide a draft reasoned decision for issue by the Examining Division (see C-V, 14); if the issue is not clear-cut, the drafting of the reasoned decision should be deferred until the Division has discussed the case.

## **4. Tasks of the other members of the Examining Division**

When an application is referred to the other members of the Division, they will first consider the case individually and each will indicate his opinion on the course of action to be taken. If there is complete agreement with the recommendation of the primary examiner, no further consultation of the Division will be necessary. When further action is needed, the primary examiner will be entrusted with the work. If, however, there is not complete agreement immediately with the primary examiner, or at least one member of the Division wishes to discuss the case further, further consultation of the Division will be arranged. In such discussions, the Division should try to reach a unanimous opinion, but where this seems unlikely, the difference of opinion must be resolved by voting. When the Division is enlarged to four members (see C-VIII, 7), the chairman has a casting vote should this be necessary.

*Art. 18(2)*

The other members of the Examining Division should bear in mind that their function generally is not to perform a complete re-examination of the application. If, following a discussion, the conclusions of the examiner entrusted with the examination are generally considered to be reasonable, the other members should accept them.

#### **5. Further communication with the applicant**

If, in the opinion of the Examining Division, the possibility exists of amending the application to bring it into a form which meets the requirements of the EPC, then the primary examiner should be entrusted with the task of informing the applicant that the Examining Division is of the opinion that the application should be refused on certain grounds unless satisfactory amendments are submitted within a stated period (see C-VI, 1). If, within the time limit, satisfactory amendments are made, the examiner will then report back to the Examining Division recommending that the application should proceed to grant. If not, he should report back recommending refusal.

#### **6. Decision**

Any decision is issued by the Examining Division as a whole and not by an individual examiner. All members, therefore, sign the written decision irrespective of whether or not it was a unanimous one. A seal may replace the signature.

*Rule 113*

#### **7. Enlargement of the Examining Division; consultation of a legally qualified examiner**

If the Examining Division considers that the nature of the decision so requires, it is enlarged by the addition of a legally qualified examiner.

*Art. 18(2)*

The participation of a legally qualified examiner or at least internal consultation of Directorate Patent Law, the department responsible for providing legally qualified members for Examining and Opposition Divisions, will be required if a difficult legal question arises which has not yet been solved by the Guidelines or by jurisprudence.

If the Examining Division has been enlarged by the addition of a legally qualified examiner, it consists of four members. In this case, in the event of parity of votes, the vote of the chairman will be decisive. As a rule, this enlargement of the Examining Division will be required in cases where evidence has to be taken according to Rule 117 (including the giving of evidence by witnesses - see E-III). The addition of a legally qualified examiner is to be considered also in the case of oral proceedings. Such enlargement will also be necessary in cases involving technical opinions (Art. 25 - see E-XI, 3.1).

Depending on the nature of the problem, as an alternative to the enlargement of the Examining Division, internal consultation of a legally qualified examiner in Directorate Patent Law may take place. For instance, doubts may arise whether an application concerns an invention within the meaning of Art. 52(2) or whether the claimed invention is excluded from patentability by virtue of Art. 53.

Consultation of a legally qualified examiner may also be appropriate in cases where legal considerations are predominant in respect to a decision, as in proceedings following a request for re-establishment of rights according to Art. 122. The formalities officer may also consult Directorate Patent Law in cases within the scope of the duties transferred to him according to Rule 11(3) (see the Decision of the President of the EPO dated 12 December 2013, OJ EPO 2014, A6).



## Chapter IX – Special applications

### 1. Divisional applications (see also A-IV, 1)

#### 1.1 General remarks

Subsequent to the filing of a European application or upon entry into the European phase of a Euro-PCT application, a divisional application may be filed. The divisional application is accorded the same date of filing as the parent application and has the benefit of any right of priority of the parent application in respect of the subject-matter contained in the divisional application. However, the parent application must be pending when a divisional application is filed (A-IV, 1.1.1). A European application may give rise to more than one divisional application. A divisional application may itself give rise to one or more divisional applications. *Art. 76(1)*

Divisional applications are to be treated in the same manner as ordinary applications and subject to the same requirements as these unless specific provisions of the EPC, in particular Art. 76 or Rule 36, require something different (G 1/05, G 1/06).

#### 1.2 Voluntary and mandatory division

The applicant may file a divisional application of his own volition (voluntary division). The most common reason, however, for filing a divisional application is to meet an objection under Art. 82 due to lack of unity of invention (mandatory division). If the examiner raises an objection due to lack of unity, the applicant is allowed a period (see C-VI, 1) in which to limit his application to a single invention. The limitation of the parent application has to be clear and unconditional. The communication inviting the applicant to limit the application due to lack of unity should therefore include a reference to the fact that if the application is not limited within the set time limit the application may be refused. *Art. 82*

#### 1.3 Abandonment of subject matter

The mere deletion of subject-matter in the parent application is not prejudicial to the later filing of a divisional application. When deleting subject-matter, the applicant should, however, avoid any statements which could be interpreted as abandonment with substantive effect, thereby impeding the valid filing of a divisional application for that subject-matter (see also H-III, 2.5, last paragraph).

#### 1.4 Examination of a divisional application

The substantive examination of a divisional application should in principle be carried out as for any other application but the following special points need to be considered. The claims of a divisional application need not be limited to subject-matter already claimed in claims of the parent application. Furthermore, no abuse of the system of divisional applications can be identified in the mere fact that the claims of the application on which the Examining Division had then to *Art. 76(1)*

decide had a broader scope than the claims granted in relation with the parent application (see T 422/07).

However, under Art. 76(1), the subject-matter may not extend beyond the content of the parent application as filed. If a divisional application as filed contains subject-matter additional to that contained in the parent application as filed, it can be amended later in order that its subject-matter no longer extends beyond the earlier content, even at a time when the earlier application is no longer pending (see G 1/05). If the applicant is unwilling to remedy the defect by removal of that additional subject-matter, the divisional application must be refused under Art. 97(2) due to non-compliance with Art. 76(1).

It cannot be converted into an independent application taking its own filing date. Moreover, a further divisional application for this additional subject-matter should also be refused under Art. 97(2) due to non-compliance with Art. 76(1).

*Art. 123(2)*

Amendments made to a divisional application subsequent to its filing must comply with the requirements of Art. 123(2), i.e. they may not extend the subject-matter beyond the content of the divisional application as filed (see G 1/05 and T 873/94). If those amendments have not been identified and/or their basis in the application as filed not indicated by the applicant (see H-III, 2.1) and the application is one of those mentioned in H-III, 2.1.4, the Examining Division may send a communication according to Rule 137(4) requesting the applicant to provide this information (see H-III, 2.1.1).

If the subject-matter of a divisional application is restricted to only a part of the subject-matter claimed in the parent application, this part of the subject-matter must be directly and unambiguously derivable from the parent application as being a separate part or entity, i.e. one which can even be used outside the context of the invention of the parent application (see T 545/92).

In the case of a sequence of applications consisting of a root (originating) application followed by divisional applications, each divided from its predecessor (see A-IV, 1.1.2), it is a necessary and sufficient condition for a divisional application of that sequence to comply with Art. 76(1), second sentence, that anything disclosed in that divisional application be directly and unambiguously derivable from what is disclosed in each of the preceding applications as filed (see G 1/06).

### **1.5 Description and drawings**

The description and drawings of the parent application and the or each divisional application should in principle be confined to matter which is relevant to the invention claimed in that application. However, amendment of the description should be required only where it is absolutely necessary. Thus the repetition in a divisional application of matter in the parent application need not be objected to unless it is

clearly unrelated to or inconsistent with the invention claimed in the divisional application. As for the matter of cross-references, there is no need for the examiner to check in the description since, under present practice, cross-references are always made between the parent and divisional applications. These appear on the front page of the respective application and patent published after receipt of the divisional application, unless the technical preparations for publication have already been completed.

## 1.6 Claims

The parent and divisional applications may not claim the same subject-matter, even in different words (see G-IV, 5.4). The difference between the claimed subject-matter of the two applications must be clearly distinguishable. As a general rule, however, one application may claim its own subject-matter in combination with that of the other application. In other words, if the parent and divisional applications claim separate and distinct elements A and B respectively which function in combination, one of the two applications may also include a claim for A plus B.

## 2. Applications resulting from a decision under Art. 61

### 2.1 General remarks

In certain circumstances, before a patent has been granted on a particular application, it may be adjudged as a result of a final decision of a national court that a person other than the applicant is entitled to the grant of a patent thereon. In this event this third party may either:

- |       |   |                      |
|-------|---|----------------------|
| (i)   | prosecute the application as his own application in place of the applicant; | <i>Art. 61(1)(a)</i> |
| (ii)  | file a new European patent application in respect of the same invention; or | <i>Art. 61(1)(b)</i> |
| (iii) | request that the application be refused.                                    | <i>Art. 61(1)(c)</i> |

(See also G-V, 3).

If the third party adopts the first of these options, he becomes the applicant in place of the former applicant and the prosecution of the application is continued from the position at which it was interrupted.

If, however, the third party files a new application under Art. 61(1)(b), the provisions of Art. 76(1) apply to this new application *mutatis mutandis*. This means that the new application is treated as though it were a divisional application i.e. it takes the date of filing and the benefit of any priority right of the original application. The examiner must therefore ensure that the subject-matter content of the new application does not extend beyond the content of the original application as filed. The original application is deemed to be withdrawn

*Art. 61(1) and (2)*  
*Rule 17(1)*

on the date of filing of the new application for the designated States concerned.

## **2.2 Original application no longer pending**

In cases where the original application has been withdrawn, refused or deemed to be withdrawn and is thus no longer pending, Art. 61(1)(b) is applicable, thus allowing the third party to still file a new European patent application in respect of the same invention (see G 3/92).

## **2.3 Partial entitlement**

*Rule 18(1)*

If, by a final decision, it is adjudged that a third party is entitled to the grant of a European patent in respect of only part of the matter disclosed in the European patent application, then the foregoing considerations apply only to that part. In such a case, option (i) mentioned in C-IX, 2.1 is not open to the third party and, regarding option C-IX, 2.1(ii), the new application must be confined to that part of the original subject-matter to which he has become entitled. Similarly, the original application must, for the designated States concerned, be confined to the subject-matter to which the original applicant remains entitled. The new application and the amended original application will stand in a relationship to each other similar to that pertaining between two divisional applications, and they will each stand in a relationship to the original application similar to that in which divisional applications stand in relation to the application from which they are divided. The guidance set out in C-IX, 1.4, 1.5 and 1.6 is therefore applicable to this situation.

## **2.4 Entitlement for certain designated States only**

*Rule 18(2)*

Where the final decision on entitlement applies only to some of the designated States, the original application may contain different claims, description and drawings for those States compared with the others (see H-III, 4.1, last paragraph, and 4.3).

If the sole result of the application of Art. 61(1) is to divide the right to the grant between the original applicant and the third party so that each may apply for the entire subject-matter for different designated States, each application should be examined in the normal way without regard to the other, with the proviso that the subject-matter of each application must not extend beyond that of the original application.

## **3. Applications where a reservation has been entered in accordance with Art. 167(2)(a) EPC 1973**

See H-III, 4.4.

## **4. International applications (Euro-PCT applications)**

For more details on this topic, see E-VIII.



# **Part D**

## **Guidelines for Opposition and Limitation/Revocation Procedures**



## Contents

### **Chapter I – General remarks I-1**

<b>1.</b>	<b>The meaning of opposition</b>	<b>I-1</b>
<b>2.</b>	<b>Opposition after surrender or lapse</b>	<b>I-1</b>
<b>3.</b>	<b>Territorial effect of the opposition</b>	<b>I-1</b>
<b>4.</b>	<b>Entitlement to oppose</b>	<b>I-1</b>
<b>5.</b>	<b>Intervention of the assumed infringer</b>	<b>I-2</b>
<b>6.</b>	<b>Parties to opposition proceedings</b>	<b>I-2</b>
<b>7.</b>	<b>Representation</b>	<b>I-3</b>
<b>8.</b>	<b>Information to the public</b>	<b>I-3</b>

### **Chapter II – The Opposition Division II-1**

<b>1.</b>	<b>Administrative structure</b>	<b>II-1</b>
<b>2.</b>	<b>Composition</b>	<b>II-1</b>
2.1	Technically qualified examiners	II-1
2.2	Legally qualified examiners	II-1
2.3	Chairman	II-1
<b>3.</b>	<b>Allocation of duties and appointment of members of the Opposition Division</b>	<b>II-1</b>
<b>4.</b>	<b>Tasks of the Opposition Divisions</b>	<b>II-1</b>
4.1	Examination of oppositions	II-1
4.2	Decision concerning the awarding of costs by the Opposition Division	II-2
4.3	Ancillary proceedings	II-2
<b>5.</b>	<b>Allocation of tasks to members</b>	<b>II-2</b>
<b>6.</b>	<b>Duties and powers of members</b>	<b>II-2</b>
<b>7.</b>	<b>Allocation of individual duties</b>	<b>II-3</b>

## **Chapter III – Opposition** **III-1**

- |           |   |              |
|-----------|---|--------------|
| <b>1.</b> | <b>Time allowed for filing notice of opposition</b> | <b>III-1</b> |
| <b>2.</b> | <b>Opposition fee</b>                               | <b>III-1</b> |
| <b>3.</b> | <b>Submission in writing</b>                        | <b>III-1</b> |
| 3.1       | Form of the opposition                              | III-1        |
| 3.2       | Notices of opposition filed electronically          | III-1        |
| 3.3       | Notices of opposition filed by fax                  | III-1        |
| 3.4       | Signature of the notice of opposition               | III-2        |
| <b>4.</b> | <b>Derogations from language requirements</b>       | <b>III-2</b> |
| <b>5.</b> | <b>Grounds for opposition</b>                       | <b>III-2</b> |
| <b>6.</b> | <b>Content of the notice of opposition</b>          | <b>III-3</b> |

## **Chapter IV – Procedure up to substantive examination** **IV-1**

- |           |   |             |
|-----------|---|-------------|
| <b>1.</b> | <b>Examination for deficiencies in the notice of opposition and communications from the formalities officer arising from this examination</b>                   | <b>IV-1</b> |
| 1.1       | Forwarding of the notice of opposition to the formalities officer   | IV-1        |
| 1.2       | Examination for deficiencies in the notice of opposition  | IV-1        |
| 1.2.1     | Deficiencies which, if not remedied, lead to the opposition being deemed not to have been filed   | IV-1        |
| 1.2.2     | Deficiencies which, if not remedied, lead to the opposition being rejected as inadmissible  | IV-2        |
| 1.2.2.1   | Deficiencies under Rule 77(1)   | IV-3        |
| 1.2.2.2   | Deficiencies under Rule 77(2)   | IV-5        |
| 1.3       | Issue of communications by the formalities officer as a result of examination for deficiencies  | IV-6        |
| 1.3.1     | Communication in the event of deficiencies as described in D-IV, 1.2.1, which, if not remedied, will lead to the opposition being deemed not to have been filed | IV-6        |
| 1.3.2     | Communication in the event of deficiencies as described in D-IV, 1.2.2, which, if not remedied,   |             |

---

	will lead to rejection of the opposition as inadmissible	IV-6
1.3.3	Extent of the formalities officer's obligation to issue the above communications	IV-7
1.4	Subsequent procedure in the event of deficiencies which may no longer be remedied	IV-7
1.4.1	Deficiencies which may no longer be remedied, as a result of which the opposition is deemed not to have been filed	IV-7
1.4.2	Deficiencies which may no longer be remedied in accordance with Rule 77(1) and (2), resulting in the opposition being rejected as inadmissible	IV-7
1.5	Notifications to and observations by the proprietor	IV-8
1.6	Subsequent procedure	IV-8
<b>2.</b>	<b>Activity of the Opposition Division</b>	<b>IV-8</b>
<b>3.</b>	<b>Rejection of the opposition as inadmissible by the Opposition Division, the proprietor of the patent not being a party</b>	<b>IV-9</b>
<b>4.</b>	<b>Termination of opposition proceedings in the event of inadmissible opposition</b>	<b>IV-9</b>
<b>5.</b>	<b>Preparation of substantive examination</b>	<b>IV-10</b>
5.1	Inadmissibility at a later stage	IV-10
5.2	Invitation to the proprietor of the patent to submit comments and communication of opposition to the other parties concerned by the formalities officer	IV-10
5.3	Filing of amended documents in reply to the notice of opposition	IV-11
5.4	Communication of observations from one of the parties to the other parties	IV-11
5.5	Decision concerning the admissibility of an opposition, the proprietor of the patent being a party	IV-12
5.6	Examination of the admissibility of an intervention and preparations in the event of an intervention	IV-12

## **Chapter V – Substantive examination of opposition** **V-1**

- 1. Beginning of the examination of the opposition** **V-1**
- 2. Extent of the examination** **V-1**
  - 2.1 Extent to which the patent is opposed V-1
  - 2.2 Examination of the grounds for opposition V-1
- 3. Non-patentability pursuant to Art. 52 to 57** **V-3**
- 4. Insufficient disclosure of the invention** **V-3**
- 5. Clarity of claims** **V-3**
- 6. Subject-matter of the European patent extending beyond the original disclosure** **V-3**
  - 6.1 Basis of this ground for opposition V-3
  - 6.2 Distinction between allowable and unallowable amendments V-4

## **Chapter VI – Procedure for the examination of the opposition** **VI-1**

- 1. General remarks** **VI-1**
- 2. Adherence to the text of the European patent submitted or approved by the proprietor** **VI-2**
  - 2.1 Basis for the examination VI-2
  - 2.2 Revocation of the patent VI-2
- 3. Invitation to file observations** **VI-2**
  - 3.1 Examiners' communications VI-2
  - 3.2 Summons to oral proceedings VI-2
- 4. Communications from the Opposition Division to the proprietor of the patent** **VI-3**
  - 4.1 Communications from the Opposition Division; reasoned statement VI-3
  - 4.2 Invitation to file amended documents VI-3

<b>5.</b>	<b>Additional search</b>	<b>VI-3</b>
<b>6.</b>	<b>Examination of the opposition during oral proceedings</b>	<b>VI-4</b>
<b>7.</b>	<b>Preparation of the decision</b>	<b>VI-4</b>
7.1	General remarks	VI-4
7.2	Preparation of a decision to maintain a European patent in amended form	VI-4
7.2.1	Procedural requirements	VI-4
7.2.2	Decision on the documents on the basis of which the patent is to be maintained	VI-6
7.2.3	Request for publishing fee and translations	VI-6

## **Chapter VII – Details and special features of the proceedings** **VII-1**

<b>1.</b>	<b>Sequence of proceedings</b>	<b>VII-1</b>
1.1	Basic principle	VII-1
1.2	Exceptions	VII-1
<b>2.</b>	<b>Request for documents</b>	<b>VII-1</b>
<b>3.</b>	<b>Unity of the European patent</b>	<b>VII-2</b>
3.1	Basic principle	VII-2
3.2	Factors affecting the unity of the European patent	VII-3
<b>4.</b>	<b>Procedure where the proprietor is not entitled</b>	<b>VII-3</b>
4.1	Stay of proceedings	VII-3
4.1.1	Date of the stay of proceedings	VII-3
4.1.2	Legal character and effect of the stay of proceedings	VII-3
4.2	Continuation of proceedings	VII-4
4.2.1	Continuation after a final decision	VII-4
4.2.2	Continuation regardless of the stage reached in national proceedings	VII-4
4.3	Interruption of time limits	VII-4
4.4	Department responsible	VII-5

<b>5.</b>	<b>Continuation of the opposition proceedings in the cases covered by Rule 84</b>	<b>VII-5</b>
5.1	Continuation in the case of surrender or lapse of the patent	VII-5
5.2	Continuation on the death or legal incapacity of the opponent	VII-5
5.3	Continuation after the opposition has been withdrawn	VII-6
<b>6.</b>	<b>Intervention of the assumed infringer</b>	<b>VII-6</b>
<b>7.</b>	<b>Publication of a new specification of the patent</b>	<b>VII-8</b>
<b>8.</b>	<b>Transitional provisions for Art. 54(4) EPC 1973 and Art. 54(5)</b>	<b>VII-8</b>
<b>Chapter VIII – Decisions of the Opposition Division</b>		<b>VIII-1</b>
<b>1.</b>	<b>Final decisions on an admissible opposition</b>	<b>VIII-1</b>
1.1	General remarks	VIII-1
1.2	Revocation of the European patent	VIII-1
1.2.1	Revocation on substantive grounds	VIII-1
1.2.2	Revocation for failure to pay the prescribed fee for publishing or to file a translation	VIII-1
1.2.3	Revocation for failure to notify the appointment of a new representative	VIII-1
1.2.4	Revocation in the event of requirements not being met until after expiry of time limits	VIII-2
1.2.5	Revocation of the patent in the event that the proprietor no longer wishes the patent to be maintained as granted	VIII-2
1.3	Rejection of the opposition	VIII-2
1.4	Maintenance of the European patent as amended	VIII-2
1.4.1	Taking of a final decision	VIII-2
1.4.2	Statement in the decision of the amended form of the European patent	VIII-2
<b>2.</b>	<b>Other decisions</b>	<b>VIII-3</b>
2.1	Decision on the inadmissibility of an opposition or intervention	VIII-3



2.2	Decisions which do not terminate proceedings	VIII-3
2.3	Decision on a notified loss of rights at the request of the person concerned	VIII-3
2.4	Decision on re-establishment of rights	VIII-3
2.5	Decision on closure of the opposition proceedings	VIII-3

## **Chapter IX – Costs**

## **IX-1**

<b>1.</b>	<b>Charging of costs</b>	<b>IX-1</b>
1.1	General principle	IX-1
1.2	Decisions on the apportionment of costs	IX-1
1.3	Costs to be taken into consideration	IX-1
1.4	Principle of equity	IX-2
<b>2.</b>	<b>Procedure for the fixing of costs</b>	<b>IX-3</b>
2.1	Fixing of costs by the Opposition Division	IX-3
2.2	Appeal against the fixing of costs by the Opposition Division	IX-3
<b>3.</b>	<b>Enforcement of the fixing of costs</b>	<b>IX-3</b>

## **Chapter X – Limitation and revocation procedure**

## **X-1**

<b>1.</b>	<b>Introduction</b>	<b>X-1</b>
<b>2.</b>	<b>Examination for deficiencies in the request</b>	<b>X-1</b>
2.1	Deficiencies which lead to the request being deemed not to have been filed	X-1
2.2	Deficiencies which, if not remedied, lead to the request being rejected as inadmissible	X-2
<b>3.</b>	<b>Decision on request for revocation</b>	<b>X-3</b>
<b>4.</b>	<b>Substantive examination (limitation)</b>	<b>X-3</b>
4.1	Department responsible	X-3
4.2	Basis for the examination	X-3
4.3	Scope of the examination	X-3

---

4.4	Further stages of the examination	X-4
4.5	Third-party observations during the examination	X-5
<b>5.</b>	<b>Formal procedure for limitation when the request is allowable</b>	<b>X-5</b>
<b>6.</b>	<b>Rejection of the request</b>	<b>X-6</b>
<b>7.</b>	<b>Relation to opposition proceedings</b>	<b>X-6</b>
7.1	Precedence of opposition proceedings	X-6
7.2	Filing of opposition after decision on limitation	X-7
<b>8.</b>	<b>Legal status of decisions</b>	<b>X-7</b>
<b>9.</b>	<b>Withdrawal of the request</b>	<b>X-7</b>
<b>10.</b>	<b>Different sets of claims</b>	<b>X-7</b>
10.1	Limitation results in the claims becoming different in different Contracting States	X-7
10.2	Limitation is different for different Contracting States because the claims as granted were different for different Contracting States	X-8
<b>11.</b>	<b>Multiple requests</b>	<b>X-8</b>

## Chapter I – General remarks

### 1. The meaning of opposition

The public may oppose a granted European patent on the basis of one or more of the grounds mentioned in Art. 100. The grounds on which the opposition is based may arise for example from circumstances of which the EPO was not aware when the patent was granted (e.g. prior use or a publication which was not contained or not found among the material available to the EPO). Opposition is therefore a means by which any person (but see D-I, 4) may obtain the limitation or revocation of a wrongly granted patent.

### 2. Opposition after surrender or lapse

An opposition may be filed even if the European patent has been surrendered or has lapsed for all the designated States. This is relevant in that in such cases the rights acquired with the patent remain in existence during the period up to surrender or lapse and claims arising from such rights may subsist after that date.

*Rule 75*

### 3. Territorial effect of the opposition

The opposition applies to the European patent in all the Contracting States in which that patent has effect. Thus the opposition should formally be in respect of all the designated States. If an opposition is filed in respect of only some of the designated States it will be treated as if it were in respect of all the designated States.

*Art. 99(2)*

Nevertheless, the effect of an opposition may differ as between Contracting States. This may arise where the patent contains different claims for different Contracting States in accordance with Rule 18(2) or Rule 138, or where the claims must take account of different art under the provisions of Art. 54(3) and (4) EPC 1973 (see D-VII, 8, and H-III, 4.2.1). Thus the patent may be differently amended in respect of different Contracting States and may be revoked in respect of one or more Contracting States and not in respect of others.

### 4. Entitlement to oppose

"Any person" may give notice of opposition without specifying any particular interest. "Any person" is to be construed in line with Art. 58 as meaning any natural person (private individual, self-employed persons, etc.), any legal person or any body assimilated to a legal person under the law governing it. "Any person" does not include the proprietor of the patent (see G 9/93, reversing G 1/84).

*Art. 99(1)*

Notice of opposition may also be filed jointly by more than one of the persons mentioned above. In order to safeguard the rights of the patent proprietor and in the interests of procedural efficiency, it has to be clear throughout the procedure who belongs to the group of common opponents. If a common opponent (including the common representative) intends to withdraw from the proceedings, the EPO must be notified accordingly by the common representative or by a

new common representative determined under Rule 151(1) in order for the withdrawal to take effect (see also G 3/99).

Oppositions are not assignable but may be inherited or succeeded to as part of an overall succession in law, e.g. in the event of the merger of legal persons (see G 4/88). Acquiring companies may also take over oppositions filed by acquired companies. However, a legal person who was a subsidiary of the opponent when the opposition was filed and who carries on the business to which the opposed patent relates cannot acquire the status as opponent if all its shares are assigned to another company (see G 2/04).

The European Patent Office has to examine, *ex officio*, the validity of any purported transfer of opponent status to a new party at all stages of the proceedings (see T 1178/04).

### **5. Intervention of the assumed infringer**

*Art. 105(1) and (2)*  
*Rule 89*

Under certain conditions (see D-VII, 6) any third party who proves that proceedings for infringement of the opposed patent have been instituted against him or that the proprietor of the patent has requested him to cease alleged infringement of the patent and that he has instituted proceedings for a court ruling that he is not infringing the patent may, after the opposition period has expired, intervene in the opposition proceedings. Once the notice of intervention has been filed in good time and in due form, the intervention is to be treated as an opposition (see D-IV, 5.6). For accelerated processing of oppositions on request, see E-VII, 4.

### **6. Parties to opposition proceedings**

*Art. 99(3)*  
*Art. 105(2)*  
*Art. 115*

The proprietor of the patent, the opponent and, where applicable, the intervener will be parties to the opposition proceedings. However, an opponent who has withdrawn his opposition or whose opposition has been rejected as inadmissible will remain a party to the proceedings only until the date of such withdrawal or the date on which the decision on rejection has become final. The same will apply in the case of interveners. Third parties who have presented observations concerning the patentability of the invention in respect of which an application has been filed are not parties to opposition proceedings (see E-V, 3).

*Art. 118*

Where the proprietors of a European patent are not the same in respect of different designated Contracting States, they are to be regarded as joint proprietors for the purposes of opposition proceedings (see D-VII, 3.1, concerning the unity of the European patent).

*Art. 99(4)*  
*Art. 61(1)(a)*

Where a person provides evidence that in a Contracting State, following a final decision, he has been entered in the patent register of that State instead of the previous proprietor, he is entitled on request to replace the previous proprietor in respect of that State. In this event, by derogation from Art. 118, the previous proprietor and

the person making the request are not deemed to be joint proprietors unless both so request. The aim of this provision is to afford the new proprietor the opportunity of defending himself against the opposition as he sees fit (see D-VII, 3.2, as regards the conduct of the opposition proceedings in such cases).

The Legal Division is responsible for decisions in respect of entries in the Register of European Patents (see the Decision of the President of the EPO dated 21 November 2013, OJ EPO 2013, 600). *Art. 20(1)*



### **7. Representation**

As regards the requirements relating to representation of opponents and patent proprietors, reference is made to A-VIII, 1. Deficiencies in the representation of an opponent when filing the opposition and their remedy are treated in D-IV, 1.2.1(ii) and 1.2.2.2(iv).

### **8. Information to the public**

As soon as an opposition has been received, the date of filing of the opposition is entered in the Register of European Patents and published in the European Patent Bulletin. The same applies to the date on which opposition proceedings are concluded and to the outcome of the proceedings (see also A-XI, 4).



## Chapter II – The Opposition Division

### 1. Administrative structure

Each Opposition Division is part of an EPO directorate comprising several Examining and Opposition Divisions. *Rule 11(1)*

### 2. Composition

#### 2.1 Technically qualified examiners

An Opposition Division consists of three technical examiners, at least two of whom must not have taken part in the proceedings for grant of the patent to which the opposition relates. *Art. 19(2)*

#### 2.2 Legally qualified examiners

If the Opposition Division considers that the nature of the decision so requires, it is enlarged by the addition of a legally qualified examiner who has not taken part in the proceedings for grant. *Art. 19(2)*

The principles established for inclusion of a legally qualified member and for consultation of the Directorate Patent Law, the department responsible for providing legally qualified members for Examining and Opposition Divisions, by the Examining Division apply *mutatis mutandis* to the Opposition Division (see C-VIII, 7). Difficult legal questions may also arise during the examination as to whether an opposition is to be rejected as inadmissible. In addition, consultation of a legally qualified member should be envisaged in cases where it is questionable whether or not a disclosure by means other than a document was made available to the public.

#### 2.3 Chairman

The Chairman must be a technically qualified examiner who has not taken part in the grant proceedings.

### 3. Allocation of duties and appointment of members of the Opposition Division

C-II, 2, applies *mutatis mutandis*. *Rule 11(1)*

### 4. Tasks of the Opposition Divisions

#### 4.1 Examination of oppositions

The Opposition Divisions are responsible for the examination of oppositions against European patents. *Art. 19(1)*

The examination of newly submitted documents for compliance with physical requirements will essentially be the task of the competent formalities officers (see D-II, 7, A-I, 2, A-III, 3.2, and C-VIII, 1).

## **4.2 Decision concerning the awarding of costs by the Opposition Division**

*Art. 104(2)*  
*Rule 88(3) and (4)* The Opposition Division will decide on requests to have the costs fixed by the formalities officer reviewed (see D-II, 7 and D-IX, 2.1).

## **4.3 Ancillary proceedings**

*Art. 122(2)*  
*Rule 136(4)*  
*Rule 112(2)* It will be incumbent upon the Opposition Division to conduct ancillary proceedings arising in the course of opposition proceedings, such as the processing of requests for re-establishment of rights in respect of a time limit which was not observed vis-à-vis the EPO during the opposition proceedings or of requests for a decision concerning a finding arrived at by the formalities officer that a right has been lost. Additional tasks may be entrusted to the Opposition Divisions by the President of the EPO in accordance with Rule 11(2).

## **5. Allocation of tasks to members**

*Art. 19(2)*  
*Rule 119(1)* An Opposition Division will normally entrust one of its members with the examination of the opposition, but not with the conduct of oral proceedings, up to the time of the final decision on the opposition (see also D-IV, 2). If need be, he may also be entrusted with the examination of the evidence adduced (see E-III, 1.3). He will be referred to as the primary examiner.

## **6. Duties and powers of members**

The primary examiner will conduct the examination of the opposition. If oral proceedings have been requested, they are normally arranged as first action, possibly in conjunction with the taking of evidence (see E-II, 1 to 4 and E-III, 1.6.1). The primary examiner will prepare the communication accompanying the summons to oral proceedings and submit it to the other members. If the primary examiner considers that communications to the parties preceding the summons for oral proceedings are necessary, he should submit the communication to the Opposition Division before despatch.

If there are differences of opinion within the Opposition Division, the primary examiner should confer with the other members to discuss the points at issue. The Chairman will preside at the meeting and, following a discussion, will take a vote on the decision or the further course of the procedure.

*Art. 19(2)* Voting will be on the basis of a simple majority. In the event of parity of votes, the vote of the Chairman of the Division is decisive.

Any further measures necessary will as a rule be entrusted to the primary examiner. If no further measures are necessary, the primary examiner will draft a decision on the opposition and will distribute the draft to the other members of the Opposition Division for examination and signature. If any changes are proposed by a member and there are differences of opinion on such changes, the Chairman must arrange a meeting.



Where reference is made hereinafter to the Opposition Division, this should be taken to mean the primary examiner where such a member has been appointed and insofar as he is entitled to act alone under the EPC.

#### **7. Allocation of individual duties**

The President of the EPO may entrust to employees who are not technically or legally qualified examiners the execution of individual duties falling to the Examining Divisions or to the Opposition Divisions and involving no technical or legal difficulties. Insofar as such duties affect the public, their allocation will be notified in the Official Journal of the EPO (see Decision of the President of the EPO dated 12 December 2013, OJ EPO 2014, A6).

*Rule 11(3)*



The formalities officers entrusted with these duties are also in charge of fixing the amount of the costs (see D-IX, 2.1).



## Chapter III – Opposition

### 1. Time allowed for filing notice of opposition

Within nine months from the publication of the mention of the grant of the European patent, notice of opposition has to be given to the EPO in Munich, The Hague or Berlin. *Art. 99(1)*

For expiry of the time limit see E-VII, 1.4. Re-establishment of rights in respect of unobserved time limits for opposition is not possible in the case of an opponent (see, however, E-VII, 2.2.2).

### 2. Opposition fee

The amount of the opposition fee specified in the Rules relating to Fees under the EPC must be paid before expiry of the time limit for opposition. *Art. 99(1)*

An opposition filed in common by two or more persons, which otherwise meets the requirements of Art. 99 and Rules 3 and 76, is admissible on payment of only one opposition fee (see G 3/99).

As regards the legal consequences and the procedure where the fee is not paid in good time, see D-IV, 1.2.1(i), and 1.4.1.

---

### 3. Submission in writing

#### 3.1 Form of the opposition

The notice of opposition must be filed in writing and should be typewritten or printed, with a margin of about 2.5 cm on the left hand side of each page. It would be appropriate if the notice of opposition also satisfied the requirements laid down in Rule 49(3). *Rule 86*  
*Rule 50(2)*  
*Rule 49(3)*  
*Rule 76(1)*

#### 3.2 Notices of opposition filed electronically

Notice of opposition may be filed in electronic form using version 5 or later releases of the EPO Online Filing software (see OJ EPO 2009, 182 and 2012, 448).

#### 3.3 Notices of opposition filed by fax

Notice of opposition may also be filed by fax (see the Decision of the President of the EPO dated 12 July 2007, Special edition No. 3, OJ EPO 2007, A.3). At the invitation of the EPO, written confirmation reproducing the contents of the fax and complying with the requirements of the Implementing Regulations - in particular properly signed - must be supplied. If the opponent fails to comply with this invitation in due time, the fax is deemed not to have been received (see A-VIII, 2.5). The opposition fee must in any case be paid within the opposition period. *Rule 2*

### 3.4 Signature of the notice of opposition

*Rule 50(3)*  
*Rule 2*

The notice of opposition must be signed by the person responsible, i.e. by the opponent or, where appropriate, by his representative (see also D-IV, 1.2.1(ii) and A-VIII, 1).

Initials or other abbreviated forms will not be accepted as a signature.

Where the notice of opposition is filed in electronic form, the signature may take the form of a facsimile signature, a text string signature or an enhanced electronic signature (see OJ EPO 2009, 182).

Where the notice of opposition is filed by fax, the reproduction on the facsimile of the signature of the person filing the notice of opposition will be considered sufficient.

If the signature is omitted, the formalities officer must request the party, or where appropriate his representative, to affix his signature within a time limit to be laid down by the formalities officer. If signed in due time, the document retains its original date of receipt; otherwise it is deemed not to have been received (see D-IV, 1.2.1(ii) and 1.4.1).

### 4. Derogations from language requirements

Derogations from language requirements for written opposition proceedings are dealt with in A-VII, 2 and for oral opposition proceedings in E-IV.

### 5. Grounds for opposition

*Art. 99(1)*  
*Rule 76(1)*

A written reasoned statement of the grounds for opposition must be filed within the opposition period.

*Art. 100*

Opposition may only be filed on the grounds that:

*Art. 100(a)*

(i) the subject-matter of the European patent is not patentable within the terms of Art. 52 to 57, because it

- is not new (Art. 52(1), 54, 55),
- does not involve an inventive step (Art. 52(1), 56),
- is not susceptible of industrial application (Art. 52(1), 57),
- is not regarded as an invention under Art. 52(1) to (3), or
- is not patentable under Art. 53;

*Art. 100(b)*

(ii) the European patent does not disclose the invention in a manner sufficiently clear and complete for it to be carried out by a person skilled in the art (see Art. 83);

- (iii) the subject-matter of the European patent extends beyond the content of the application as filed (see Art. 123(2)) or, if the patent was granted on a divisional application or on a new application filed in accordance with Art. 61 (new application in respect of the invention by the person adjudged in a final decision to be entitled to the grant of a European patent), beyond the content of the earlier application as filed (see Art. 76(1)). *Art. 100(c)*

(See also D-V, 3, 4 and 6, and C-IV).

Note that each single condition mentioned above forms an individual legal basis for objection to the maintenance of the patent. Consequently, each such condition is to be regarded as a separate ground of opposition (see G 1/95 and G 7/95).

The following allegations, for example, do not constitute grounds for opposition: that national rights of earlier date exist which put the patentability of the invention in question (see, however, H-III, 4.5), that the proprietor of the patent is not entitled to the European patent, that the subject-matter of the patent lacks unity, that the claims are not supported by the description (unless it is also argued that the claims are so broadly worded that the description in the specification does not sufficiently disclose the subject-matter within the meaning of Art. 100(b)), that the form and content of the description or drawings of the patent do not comply with the provisions as to formal requirements as set forth in Rules 42 and 46, or that the designation of the inventor is incorrect. Nor does the simple allegation that priority has been wrongly claimed constitute a ground for opposition. However, the matter of priority must be subjected to a substantial examination in the course of opposition proceedings if prior art is invoked in connection with a ground for opposition under Art. 100(a) in relation to which the priority date is of decisive importance (see G-IV, 3 and F-VI, 2).

## 6. Content of the notice of opposition

The notice of opposition, filed in a written reasoned statement, must contain:

- (i) the name, address and nationality of the opponent and the State in which his residence or principal place of business is located. Names of natural persons must be indicated by the person's family name and given name(s), the family name being indicated before the given name(s). Names of legal entities, as well as companies considered to be legal entities by reason of the legislation to which they are subject, must be indicated by their official designations. Addresses must be indicated in such a way as to satisfy the customary requirements for prompt postal delivery at the indicated address. They must comprise all the relevant administrative units, including the house number, if any. Opponents (whether natural or legal persons) whose residence or principal place of *Rule 76(2)(a)*  
*Rule 41(2)(c)*

business is in an EPC contracting state and who act without a professional representative can use an address for correspondence other than their residence. The address for correspondence must be the opponent's own address. Post cannot be sent to a different (natural or legal) person, since that requires a valid form of representation under Art. 133 and 134. It is recommended that the telephone and fax number be indicated (see D-IV, 1.2.2.2(i) and 1.4.2);

- Rule 76(2)(b)* (ii) the number of the European patent against which opposition is filed, the name of the proprietor and the title of the invention (see D-IV, 1.2.2.2(ii) and 1.4.2);
- Rule 76(1)*  
*Rule 76(2)(c)* (iii) a statement of the extent to which the European patent is opposed and of the grounds on which the opposition is based as well as an indication of the facts and evidence presented in support of these grounds, together with a statement of reasons, i.e. arguments (see D-IV, 1.2.2.1(iii) to (v) and 1.4.2). However, in order to streamline opposition procedure it is recommended that a single copy of any written evidence be submitted as soon as possible and ideally with the notice of opposition (see D-IV, 1.2.2.1(v), last two paragraphs);
- Rule 76(2)(d)* (iv) if the opponent has appointed a representative, his name and the address of his place of business in accordance with the provisions of sub-paragraph (i) as set out above (see D-IV, 1.2.2.2(iii) and 1.4.2).

D-IV, 1 sets out further details and explains how to deal with the opposition if one of these requirements is not fulfilled.

## Chapter IV – Procedure up to substantive examination

### 1. Examination for deficiencies in the notice of opposition and communications from the formalities officer arising from this examination

#### 1.1 Forwarding of the notice of opposition to the formalities officer

The notice of opposition must be forwarded directly to the formalities officer, who then places it in the electronic file of the European patent concerned in accordance with the relevant administrative instructions and communicates it without delay to the proprietor for information. If a notice of opposition is received prior to the publication of the mention of the grant of the European patent, the formalities officer informs the sender that his document cannot be treated as an opposition. This document becomes part of the files and, as such, is also available for inspection under Art. 128(4), and is brought to the attention of the applicant for or the proprietor of the patent as an observation by a third party in accordance with Art. 115 (for details, see E-V, 3). If an opposition fee has been paid, it will in this case be refunded.

Examinations, observations, communications and, where appropriate, invitations to the parties will be the responsibility of the formalities officer who has been entrusted with this task of the Opposition Division (see D-II, 7).

#### 1.2 Examination for deficiencies in the notice of opposition

After notice of opposition has been given, the formalities officer examines whether any deficiencies exist.

##### 1.2.1 Deficiencies which, if not remedied, lead to the opposition being deemed not to have been filed

The following deficiencies fall into this category:

- (i) the opposition fee or a sufficient amount of the fee has not been paid in the course of the opposition period (Art. 99(1)). However, if the opposition fee, apart from a small amount (e.g. deducted as bank charges), has been paid within the opposition period, the formalities officer examines whether the amount lacking can be overlooked where this is justified. If the formalities officer concludes that the amount lacking can be overlooked, the opposition fee is deemed to have been paid and there is no deficiency in the present sense; *Art. 7 RFees*  
*Art. 8 RFees*
- (ii) the document giving notice of opposition is not signed and this is not rectified within the period set by the formalities officer, which is fixed at two months as a rule (see E-VII, 1.2) (Rule 50(3)).

It should be noted that for cases covered by Art. 133(2) (see also D-IV, 1.2.2.2(iv)) a professional representative first has to be appointed within the prescribed time limit. The above applies if the notice of opposition has not been signed by the representative and he has failed to remedy such deficiency either by signing it or by approving it in writing;

- (iii) where a notice of opposition is filed by fax and written confirmation reproducing the contents of the fax, if requested by Formalities, is not supplied in due time (Rule 2(1) and Decision of the President of the EPO, Special edition No. 3, OJ EPO 2007, A.3);
- (iv) where a notice of opposition is filed by the representative or employee of an opponent, and the authorisation, if any is required (see A-VIII, 1.5, and the Decision of the President of the EPO in Special edition No. 3, OJ EPO 2007, L.1), is not supplied in due time (Rule 152(1) to (3) and (6)); and
- (v) the Opposition is submitted within the opposition period but not in an official language of the EPO, as specified in Rule 3(1), or if Art. 14(4) applies to the opponent, the translation of the elements referred to in Rule 76(2)(c) is not submitted within the opposition period (see also A-VII, 2, G 6/91 and T 193/87). This period is extended where the one-month period as required under Rule 6(2) expires later. This deficiency is present if the opposition is not filed in English, French or German or if, for example, an opponent from Belgium files his opposition in time in Dutch but fails to file the translation of the essential elements into English, French or German within the above-mentioned time limits.

For oppositions which, upon submission, are deemed not to have been filed because of deficiencies as described above, see the further procedure as described in D-IV, 1.3.1, 1.3.3 and 1.4.1.

### **1.2.2 Deficiencies which, if not remedied, lead to the opposition being rejected as inadmissible**

Only such oppositions as are deemed to have been filed will be examined for deficiencies under Rule 77(1) and (2).

If the formalities officer is not sure whether the opposition in question contains a deficiency under Rule 76(2)(c), he will submit the file to the Opposition Division for checking. He will do this in particular if the opposition alleges non-patentability under Art. 52, 54 and 56 and the relevant prior art has been made available to the public by means other than by written description, or if taking of evidence has been requested in accordance with Rule 117.



In this connection the Opposition Division will also examine the extent to which it is necessary for the formalities officer to request the opponent to submit evidence (see D-IV, 1.2.2.1(v)).

#### **1.2.2.1 Deficiencies under Rule 77(1)**

The following deficiencies fall into this category:

- (i) the notice of opposition is not filed in writing with the EPO in Munich or its branch at The Hague or its sub-office in Berlin within the nine-month opposition period, calculated from the date of publication of the mention of the grant of the European patent in the European Patent Bulletin (Art. 99(1));

Accordingly, the opposition is deficient if, for example, notice of opposition is submitted to the EPO belatedly, i.e. after expiry of the nine-month period, or where the opposition is notified within the opposition period but only verbally in a telephone call officially noted in the files. This category of deficiency also includes oppositions which, notwithstanding Art. 99(1), are filed with the central industrial property office of a Contracting State or an authority thereunder and not forwarded by these offices either at all or in time for them to be received by the EPO before the expiry of the opposition period. There is no legal obligation upon these offices or authorities to forward oppositions to the EPO.

- (ii) the notice of opposition does not provide sufficient identification of the European patent against which opposition is filed;

Such a deficiency exists if the EPO is unable to identify the relevant patent on the basis of the particulars in the notice of opposition; for example, if only the proprietor of the contested patent and perhaps the title of the invention for which the patent was granted are mentioned in the notice of opposition. Such particulars alone are not an adequate description of the contested European patent, unless the proprietor of the patent who alone is named possesses only one patent or possesses several patents, the subject-matter of only one of which fits the title of the invention given in the notice of opposition, being clearly distinct from the subject-matter of the other patents which this proprietor holds. A mere indication of the number of the contested European patent in the notice of opposition constitutes sufficient identification of the patent concerned, provided that no conflicting information is given, e.g. an inconsistent name for the proprietor, and the conflict cannot be resolved from the information given.

- Rule 76(2)(c)* (iii) the notice of opposition contains no statement of the extent to which the European patent is opposed;

Such a deficiency is present if it is not clear from the requisite statement whether the opposition is directed against the entire subject-matter of the patent or only a part of it, i.e. whether it is directed against all the claims or only against one or a part of one claim, such as an alternative or embodiment;

- Rule 76(2)(c)* (iv) the notice of opposition contains no statement of the grounds on which the opposition is based;

A notice of opposition contains such a deficiency if it does not mention at least one of the grounds for opposition referred to in Art. 100 (see D-III, 5). If non-patentability is given as a ground for opposition, the statement of grounds must at least implicitly indicate which conditions for patentability (Art. 52 to 57) are considered not to have been fulfilled.

- Art. 99(1)*  
*Rule 76(2)(c)* (v) the notice of opposition does not indicate the facts, evidence and arguments presented in support of the opposition, i.e. it is not adequately substantiated;

An opposition is adequately substantiated only if in respect of at least one of his grounds for opposition the opponent adduces facts, evidence and arguments establishing a possible obstacle to patentability under the EPC. He must indicate the technical context and the conclusions he has drawn from it. The content of the statement of grounds must be such as to enable the patent proprietor and the Opposition Division to examine the alleged ground for revocation without recourse to independent enquiries. Unsubstantiated assertions do not meet this requirement. Nor as a rule is mere reference to patent documents enough; unless the document is very short the opponent must indicate on which parts his opposition is based. Where there are allegations that use or oral description are comprised in the state of the art, the Opposition Division must be supplied with an indication of the facts, evidence and arguments necessary for determination of the matters set out under G-IV, 7.2 and 7.3. See also in this respect T 328/87.

If, where there are multiple grounds for opposition, the facts, evidence and arguments for one ground are sufficiently indicated, the opposition is admissible, even if the facts, evidence and arguments in support of the other grounds for opposition are submitted belatedly. Such belated facts, evidence and arguments are in that event dealt with in accordance with E-V, 2.

It is immaterial, as far as the question of admissibility of an opposition is concerned, whether and to what extent the facts,



evidence and arguments submitted in due time actually warrant revocation of the contested European patent or its maintenance in amended form. On the one hand, an unconvincing ground of opposition may have been clearly presented and argued (making the opposition admissible), whereas conversely a deficient submission may have been rejected as inadmissible even though, if properly drafted, it could have succeeded (see also T 222/85).

=====

An indication of at least one ground of opposition and of the facts, evidence and arguments on which it is based fulfils the prerequisites for admissibility of the opposition in this respect. The evidence itself can also be produced after the expiry of the opposition period. Because of the long opposition period (9 months) it is however recommended, in order to expedite the opposition proceedings, that a single copy of any written evidence indicated in the notice of opposition be submitted as soon as possible and ideally with the notice of opposition.

*Rule 76(2)(c)*  
*Rule 83*

Otherwise, if his opposition is admissible, the opponent will be invited to supply such evidence as soon as possible and as a rule within two months. If the documents thus requested are neither enclosed nor filed within the time limit set, the Opposition Division may decide not to take into account any arguments based on them. (As regards facts or evidence not submitted in due time and arguments presented at a late stage see E-V, 2 and E-II, 8.6.)

- (vi) the opposition does not indicate beyond any doubt the identity of the person filing the opposition (Art. 99(1) and Rule 76(2)(a)).

*Art. 99(1)*  
*Rule 76(2)(a)*

#### **1.2.2.2 Deficiencies under Rule 77(2)**

The following deficiencies fall within this category:

- (i) the notice of opposition does not state the name, address and nationality of the opponent and the State in which his residence or principal place of business is located in the prescribed manner (see D-III, 6(i));
- (ii) the number of the European patent against which the opposition is filed or the name of the proprietor of the patent or the title of the invention is not indicated;

*Rule 76(2)(a)*

*Rule 76(2)(b)*

Each of the particulars listed in (ii) above must be supplied within the time limit set by the formalities officer (see D-IV, 1.3.2), even if the contested European patent may be identified by means of one of these or other particulars within the opposition period (see D-IV, 1.2.2.1(ii)). If the name of the proprietor of the patent as indicated by the opponent is

not the same as that recorded in the Register, the formalities officer will inform the opponent of the proprietor's correct name.

- Rule 76(2)(d)*
- (iii) where the opponent has appointed a representative, the name or the address of the place of business of such representative is not indicated in the notice of opposition in the prescribed manner (see D-III, 6(iv));
  - (iv) the opponent has neither his residence nor his principal place of business in one of the Contracting States (Art. 133(2)) and has not communicated the appointment of a professional representative (Art. 134). In the communication requesting him to remedy such deficiency the opponent must also be asked to arrange for the signature or approval of the notice of opposition by the representative to be appointed; and
- Rule 86*
- (v) the notice of opposition fails to satisfy further formal requirements other than those mentioned in Rule 77(1). For instance, it may fail to comply with the provisions of Rule 50(2) without due justification.

### **1.3 Issue of communications by the formalities officer as a result of examination for deficiencies**

- Art. 14(4)*  
*Rule 2(1)*  
*Rule 3(1)*  
*Rule 6(2)*  
*Rule 50(3)*  
*Rule 77(1) and (2)*  
*Rule 152(1) to (3)*
- If, in the course of his examination as described in D-IV, 1.2, the formalities officer notes deficiencies which may still be remedied, and if there are no deficiencies which may no longer be remedied (in the case of deficiencies which may no longer be remedied see D-IV, 1.4), he will issue the communications described in D-IV, 1.3.1 and/or 1.3.2, to the opponent, if possible in a single communication.

#### **1.3.1 Communication in the event of deficiencies as described in D-IV, 1.2.1, which, if not remedied, will lead to the opposition being deemed not to have been filed**

The communication will indicate the deficiencies noted in accordance with D-IV, 1.2.1, and will state that the opposition will be deemed not to have been filed unless the deficiency or deficiencies are remedied within the time limits indicated in D-IV, 1.2.1.

#### **1.3.2 Communication in the event of deficiencies as described in D-IV, 1.2.2, which, if not remedied, will lead to rejection of the opposition as inadmissible**

The communication will indicate the deficiencies noted in accordance with D-IV, 1.2.2.1 or 1.2.2.2, and will state that the opposition will be rejected as inadmissible unless the deficiencies as described in D-IV, 1.2.2.1, are remedied within the opposition period and unless the deficiencies as described in D-IV, 1.2.2.2 are remedied within the period stipulated by the formalities officer.

### **1.3.3 Extent of the formalities officer's obligation to issue the above communications**

Although the formalities officer is not obliged to do so, he should notify the opponent of deficiencies as described in D-IV, 1.2.1(i), (iii) and (iv), and D-IV, 1.2.2.1, in good time before the expiry of the time-limits within which it is still possible to remedy the deficiencies. However, the opponent can seek no legal remedy against failure to issue these communications, which should be regarded merely as a service afforded the opponent by the EPO so as largely to obviate any adverse legal consequences. Deficiencies as described in D-IV, 1.2.1(ii) and 1.2.2.2 must in any event be officially notified to the opponent, since this is a statutory requirement. Should this communication inadvertently be omitted notwithstanding deficiencies of this type in the notice of opposition, the opponent may submit the missing particulars on his own initiative at any time, even after the expiry of the opposition period without suffering adverse legal consequences.

### **1.4 Subsequent procedure in the event of deficiencies which may no longer be remedied**

#### **1.4.1 Deficiencies which may no longer be remedied, as a result of which the opposition is deemed not to have been filed**

*Rule 112(1)*

If the formalities officer establishes that the deficiencies referred to in D-IV, 1.2.1 have not been remedied within the time limits laid down in the EPC or by the EPO, he will inform the opponent in accordance with Art. 119 that the notice of opposition is deemed not to have been filed and that a decision may be applied for under the terms of Rule 112(2) (see E-VII, 1.9.3). If no such application is made within the prescribed period of two months after notification of this communication, and if there is no other valid opposition pending, the proceedings are closed and the parties informed accordingly. Any opposition fees which have been paid are refunded.

Documents submitted with a notice of opposition which is deemed not to have been filed will form part of the file and will thus be available for inspection in accordance with Art. 128(4). They will be regarded as observations by third parties under Art. 115 (see in this connection D-V, 2.2, and E-V, 3). If a further admissible opposition is pending, the proceedings are continued in respect of it.

#### **1.4.2 Deficiencies which may no longer be remedied in accordance with Rule 77(1) and (2), resulting in the opposition being rejected as inadmissible**

If there are no deficiencies of the type referred to in D-IV, 1.4.1, but a notice of opposition which is deemed to have been filed reveals deficiencies under the terms of Rule 77(1) (see D-IV, 1.2.2.1) which may no longer be remedied and which have not been communicated to the opponent in accordance with D-IV, 1.3.2 (because the opposition period has already expired), the formalities officer must, by virtue of Art. 113(1), notify the opponent of these deficiencies,

allowing him time in which to submit comments (normally two months), and point out to him that the notice of opposition is likely to be rejected as inadmissible.

If the opponent does not refute the opinion expressed by the formalities officer on the existence of deficiencies which may no longer be corrected or has failed to remedy in good time deficiencies which may be corrected (Rule 77(2)) and which were communicated to him pursuant to D-IV, 1.3.2, the formalities officer will reject the notice of opposition as inadmissible, except in the case mentioned in D-IV, 1.2.2.1(v) (for which the Opposition Division is competent to decide, see the Decision of the President of the EPO dated 12 December 2013 concerning the entrustment to non-examining staff of certain duties incumbent on the examining or opposition divisions, OJ EPO 2014, A6). As regards the form of the decision, see E-IX, 4 and 5.

In all other cases the formalities officer will submit the opposition documents to the directorate responsible for the European patent in suit (for designation of an Opposition Division, see D-IV, 2).

The decision declaring the opposition inadmissible under Rule 77(1) or (2) can be taken without the participation of the proprietor of the patent in accordance with Rule 77(3). However, for reasons of procedural economy, the substantive examination is in fact initiated if at least one further admissible opposition is pending. The proprietor of the patent may also comment on the admissibility of the former opposition in the course of that examination.

When the decision declaring the opposition inadmissible has become final the opponent concerned is no longer a party to the proceedings.

### **1.5 Notifications to and observations by the proprietor**

Communications and decisions in the course of the examination as to whether the opposition is deemed to have been filed and is admissible are also notified to the proprietor of the patent. If he files observations on his own initiative concerning such a communication, they may be taken into account in the decision.

### **1.6 Subsequent procedure**

For the subsequent procedure in the event of one or more oppositions with no deficiencies see D-IV, 5.2.

## **2. Activity of the Opposition Division**

The formalities officer submits the files to the competent directorate on expiry of the periods specified in D-IV, 5.2 and 5.5 and in the remaining cases (see D-IV, 1.4.2) immediately.

The director responsible will then designate the three technical members of the competent Opposition Division. The Opposition Division will decide whether one of its members – and if so, which – is

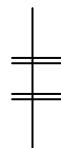

to be entrusted with the examination of the opposition up to the taking of a decision (see D-II, 5). The technical members of the Division should not be designated if the opposition is rejected as inadmissible by the formalities officer and no further admissible opposition has been filed (see D-IV, 1.4.2).

### **3. Rejection of the opposition as inadmissible by the Opposition Division, the proprietor of the patent not being a party**

(For rejection of the opposition as inadmissible at a later stage, the proprietor of the patent being a party, see D-IV, 5.1 and 5.5)

In cases of insufficient substantiation, where the formalities officer is not competent to decide on the inadmissibility (see D-IV, 1.2.2.1(v)), the Opposition Division will either:

- (i) issue the decision rejecting the opposition as inadmissible (when the formalities officer has already informed the opponent of this deficiency pursuant to D-IV, 1.3.2); or
- (ii) consider the opposition admissible and continue with examination of the opposition (see D-V); or
- (iii) communicate its findings to the opponent in question and at the same time request him to submit observations.

If the opponent does not refute the opinion expressed by the Opposition Division on the existence of these deficiencies which may no longer be corrected, the Opposition Division will reject the notice of opposition as inadmissible, possibly after having held oral proceedings. As regards the form of the decision, see E-IX, 4 and 5.

The decision will be communicated to the other parties. An inadmissible opposition or documents produced in support of an inadmissible opposition will be placed in the files and will therefore be available for inspection in accordance with Art. 128(4). As regards the possibility of taking them into consideration as observations by third parties, see D-V, 2.2 and E-V, 3. If there are further admissible oppositions, for reasons of procedural economy this decision to reject the opposition as inadmissible will normally be taken at the end of the procedure together with the decision on the admissible oppositions.

For the possibility of appeal by the opponent and other possible means of redress, see E-X, 1 and 7.

### **4. Termination of opposition proceedings in the event of inadmissible opposition**

Under the terms of Art. 101(1) and Rule 79(1), the examination as to whether the European patent can be maintained can only be performed if at least one admissible opposition has been filed. This means that the Opposition Division has to refrain from commenting on

the substantive merits of the opposition when expressing an opinion on its inadmissibility if there is no further admissible opposition (see T 925/91). Opposition proceedings are terminated if all notices of opposition filed against a European patent have been rejected as inadmissible and the last decision in this respect has become final. This will be communicated to the parties.

## **5. Preparation of substantive examination**

### **5.1 Inadmissibility at a later stage**

Since the admissibility of an opposition is always open to question by the proprietor, no separate communication that the opposition is admissible will be sent to the opponent or the proprietor of the patent. Where deficiencies on the basis of which the notice of opposition is likely to be regarded as inadmissible, but of which the opponent has not been informed by the formalities officer, come to the attention of the Opposition Division in the opposition documents submitted to it or because the proprietor has raised the issue at any stage of the proceedings, it will inform the parties about its reservations in a communication and at the same time request the opponent in question to submit observations. If deficiencies within the meaning of Rule 77(2) are involved, it is sufficient to specify a period for the opponent to remedy such deficiencies.

If the opponent does not refute the opinion expressed by the Opposition Division on the existence of these deficiencies which may no longer be corrected or fails to remedy in good time deficiencies which may be corrected, the Opposition Division will reject the notice of opposition as inadmissible, possibly after having held oral proceedings. As regards the form of the decision, see E-IX, 4 and 5. For subsequent procedure, see the last two paragraphs of D-IV, 3.

### **5.2 Invitation to the proprietor of the patent to submit comments and communication of opposition to the other parties concerned by the formalities officer**

*Rule 79(1) and (2)*

If the formalities officer considers that no further ex-officio objection to the admissibility of each or the only opposition remains, he will invite the proprietor of the patent, immediately after expiry of the opposition period or the period laid down by the formalities officer for the remedying of the deficiencies in accordance with Rule 77(2) (see D-IV, 1.2.2.2), or for the presentation of evidence (see D-IV, 1.2.2.1(v)), to file his observations concerning the oppositions communicated earlier and to file amendments, where appropriate, to the description, claims and drawings within a period to be fixed by the formalities officer (normally four months). This also applies to oppositions where a decision to the effect that they are deemed not to have been filed or are inadmissible has not yet been taken or has not yet become final.

If several notices of opposition have been filed, the formalities officer will communicate them to the other opponents at the same time as



the communication provided for in the previous paragraph. This will not be combined with an invitation to file observations or the setting of a time limit.

However, copies of documents specified as patent documents are transmitted only upon request. All documents are available for inspection via the Register Plus online service (Notice from the EPO dated 3 June 2009, OJ EPO 2009, 434).

### **5.3 Filing of amended documents in reply to the notice of opposition**

Amended documents should, provided that it is not irrelevant at the stage reached in the procedure, be as complete as possible and drawn up in such a way as to allow the European patent, where appropriate, to be maintained without further delay in the amended version.

These considerations apply also to auxiliary requests in which the proprietor proposes amendments for consideration by the Opposition Division only if the Division is unable to grant his main request, for example that the opposition should be rejected. In both cases, however, it will be more convenient in certain circumstances to determine first the form of the claims, leaving purely consequential amendments in the description to be dealt with later.

Care must be taken to ensure that any amendments do not offend against Art. 123(2) and (3) (see D-V, 6, H-IV, 4.3 and H-V, 2 and 3). It must also be checked that the patent, by the amendments **themselves**, does not contravene the requirements of the EPC (with the exception of Art. 82, see D-V, 2.2). For the form of amended documents, see H-III, 2.2 to 2.4.

### **5.4 Communication of observations from one of the parties to the other parties**

The formalities officer will, at any stage in the procedure, immediately communicate the observations of any of the parties to the other parties for information.

*Rule 79(3)*

*Rule 81(2)*

If the proprietor of the patent files amended documents with his observations, where applicable as part of an alternative request, the formalities officer will invite the other parties to submit observations within a period to be fixed by him (normally four months).

If the Opposition Division considers that observations are called for in the course of the further procedure, a separate invitation is issued and a period is fixed (normally four months), with or without a communication stating the grounds.

### **5.5 Decision concerning the admissibility of an opposition, the proprietor of the patent being a party**

If the proprietor of the patent, when replying to the notice of opposition, contends that the opposition is inadmissible pursuant to Rule 77(1) and (2), because of deficiencies which are to be specified, the opponent concerned must be given the opportunity to submit his comments within a period fixed by the formalities officer (two months).

If the Opposition Division concludes that the opposition is inadmissible, it must as a rule first take a reasoned decision, possibly after having held oral proceedings. This decision is appealable. If, on the other hand, on the basis of another – admissible – opposition, an immediate decision can be taken on the rejection of the opposition or oppositions or on the revocation of the patent, the decision on admissibility is to be taken together with this final decision.

If, despite the observations of the proprietor of the patent, the Opposition Division concludes that the opposition is admissible, the decision on admissibility is normally to be taken together with the final decision, especially where at least one other admissible opposition exists. If there are only oppositions where the admissibility is doubtful, a reasoned intermediate decision should be issued, which is appealable, provided that this will not unduly delay the proceedings.

An opponent whose opposition has been finally rejected as inadmissible is no longer a party to the subsequent proceedings once this decision becomes final.

### **5.6 Examination of the admissibility of an intervention and preparations in the event of an intervention**

*Rule 79(4)*

When examining whether an intervention is admissible, the formalities officer and the Opposition Division should proceed as for the examination as to admissibility of an opposition (see D-IV, 1, 3 and 5.5) but on the basis of the requirements for intervention under Art. 105 and Rule 89.

*Rule 86*

Paragraphs D-IV, 5.2 and 5.4, may, however, be disregarded in the case of an application for intervention in opposition proceedings.

Accordingly, particularly in the case of proceedings which are at an advanced stage, the formalities officer will inform third parties who have intervened of the progress of the proceedings and request them to indicate within one month whether they will also require the documents received from the parties in accordance with Rule 79(1), (2) and (3), together with the communications from the Opposition Division and the observations of the parties under Rule 81(2), for the preceding period. If this is the case, the formalities officer should send them with the relevant communications from the Opposition Division or the formalities officer to the intervening third party.

## Chapter V – Substantive examination of opposition

### 1. Beginning of the examination of the opposition

Once the preparations for the examination of the opposition have been completed pursuant to Rule 79, the Opposition Division examines whether the grounds for opposition (see D-III, 5) laid down in Art. 100 prejudice the maintenance of the European patent. The examination may also begin if a single admissible opposition has been withdrawn in the interim (see D-VII, 5.3). If the opponent has died or is legally incapacitated, the examination may begin even without the participation of the heirs or legal representatives (see D-VII, 5.2).

Art. 101(1)

### 2. Extent of the examination

#### 2.1 Extent to which the patent is opposed

In the unusual case where an opposition is limited to only a certain part of the patent, the Opposition Division has to limit its examination to the part opposed. However, if the opposition is directed only to an independent claim, the dependent claims are considered to be implicitly covered by the extent of the opposition and may be examined by the Opposition Division, provided their validity is *prima facie* in doubt on the basis of the information already available (see G 9/91). Similarly, if only a process claim is opposed, a product-by-process claim making reference to the same process is considered to be implicitly covered by the extent of opposition and may be examined under the same conditions as above (see T 525/96).

#### 2.2 Examination of the grounds for opposition

Opposition proceedings are not a continuation of examination proceedings. Hence as a general rule the Opposition Division will confine its examination to those grounds for opposition brought forward by the opponent. If, for example, the opposition is filed only on the grounds that the subject-matter of the European patent is not adequately disclosed or that it extends beyond the content of the patent application as filed, the Opposition Division will examine the patentability of the subject-matter of the European patent pursuant to Art. 52 to 57 only if facts have come to its notice which, *prima facie*, wholly or partially prejudice the maintenance of the patent (see G 10/91).

A document indicated in the patent specification as the closest or important prior art for the purposes of elucidating the technical problem set out in the description forms part of the opposition proceedings even if not expressly cited within the opposition period. The same applies to any relevant documents cited in the patent specification which do not constitute the closest prior art but whose contents are nevertheless important for understanding the problem

underlying the invention within the meaning of Rule 42(1)(c) EPC (T 536/88, in particular point 2.1).

Rule 81(1)  
Art. 114

Once proceedings for examining the opposition(s) have been initiated because an admissible opposition has been filed (although it may have been withdrawn in the interim), there may be reason to believe that other grounds exist which, *prima facie*, in whole or in part prejudice the maintenance of the European patent. If that is the case, these grounds should generally be examined by the Opposition Division of its own motion pursuant to Rule 81(1). Such other grounds may result from facts emerging from the search report or the examination procedure, the examiner's personal knowledge or observations presented by third parties pursuant to Art. 115 (see also E-V, 3). Such grounds may also have been put forward in another opposition which has been rejected as inadmissible, or in another opposition deemed not to have been filed. They may also be any grounds submitted belatedly (see E-V, 1.1 and 2). Under Art. 114(1), such prejudicial grounds put forward in an opposition which has been withdrawn should also generally be examined by the Opposition Division of its own motion. In carrying out such examination the Opposition Division should, however, take the interests of procedural expediency into account (see E-V, 1.2). If the decision is to be based on grounds to be taken into account pursuant to Art. 114(1) or Rule 81(1), the parties must be given the opportunity to comment (see E-IX, 1).

If during examination an allegation about a relevant fact seems plausible, it may be taken into account without further evidence if it is not challenged by the other party.

If a fact is contested or not plausible, the party making the allegation must prove it. If the parties to opposition proceedings make contrary assertions which they cannot substantiate and the Opposition Division is unable to establish the facts of its own motion, the patent proprietor is given the benefit of the doubt (see T 219/83, Headnote I).

Pursuant to Art. 100, the absence of unity of invention is not a ground for opposition (see D-III, 5).

Art. 82

Since unity of invention under Art. 82 is only required for the European patent application, the unity of the subject-matter of the European patent may not be examined by the Opposition Division, even of its own motion. In particular, where the facts, evidence and arguments which come to light in the opposition proceedings lead to the maintenance of the European patent in amended form, there should be no further examination as to whether the remaining subject-matter of the patent contains a single invention or more than one. Any lack of unity must be accepted (see G 1/91).

The grounds for opposition laid down in Art. 100 are examined in greater detail below.

### 3. Non-patentability pursuant to Art. 52 to 57

The same substantive requirements apply in the opposition procedure regarding patentability pursuant to Art. 52 to 57 as in the examination procedure. G-I to VII should therefore also be applied in opposition proceedings. However, it will be more common in opposition proceedings than in examination procedure for the examination as to patentability to be based on the state of the art as made available to the public not by written description but "by means of an oral description, by use, or in any other way" (see Art. 54(2) and G-IV, 7).

Art. 100(a)

### 4. Insufficient disclosure of the invention

Determination of whether the disclosure of an invention in a European patent application is sufficient is dealt with in F-III, 1 to 3.

The principles set out there will also apply *mutatis mutandis* to the opposition procedure. The overriding consideration in this context is the disclosed content of the European patent specification, that is to say what a person skilled in the art is able to infer from the patent claims, description and drawings, if any, without reflection as to inventiveness. Pursuant to Art. 100(b), the patent has to disclose the invention in a manner sufficiently clear and complete for it to be carried out by persons skilled in the art. If the patent specification does not disclose the invention sufficiently clearly to enable it to be carried out in accordance with Art. 100(b), this may be remedied, provided the original documents contained a sufficient disclosure, but subject to the condition that, as required under Art. 123(2), the subject-matter of the European patent does not extend beyond the content of the application as filed and, as required under Art. 123(3), the protection conferred is not extended.

Art. 100(b)

There is normally no deficiency under Art. 100(b) if a feature which is essential for performance of the invention is missing from the claim but is disclosed in the description and/or drawings. However, unduly broad claims may be objected to under Art. 56 (see T 939/92).

### 5. Clarity of claims

Objections under Art. 84 can be made only if the deficiency under Art. 84 is a consequence of the amendments made (see T 301/87).

### 6. Subject-matter of the European patent extending beyond the original disclosure

#### 6.1 Basis of this ground for opposition

This ground for opposition under Art. 100(c) refers back to Art. 123(2) and stipulates that the subject-matter of a European patent may not extend beyond the content of the application as filed. In the case of a patent granted on the basis of a European divisional application (Art. 76(1)), two criteria apply: the subject-matter must not extend

Art. 100(c)

beyond the content of the earlier application as filed (Art. 76(1)), and it must not extend beyond the content of the divisional application as filed (Art. 123(2)) (see T 873/94). Similar considerations apply to applications filed under Art. 61. In the case of a patent granted on an application filed in a language other than an official language of the EPO either in accordance with Art. 14(2) or in accordance with Rule 40 (see Rule 40(3)), the original text will, as provided for in Art. 70(2), constitute the basis for determining whether the subject-matter of the European patent extends beyond the content of the application as filed. However, unless, for example, the opponent adduces proof to the contrary the Opposition Division may, under Rule 7, assume that the translation referred to in Art. 14(2) or Rule 40(3) is in conformity with the original text of the application.

## **6.2 Distinction between allowable and unallowable amendments**

The distinction between allowable amendments to the content of a European patent application and amendments which are at variance with Art. 123(2) or Art. 76(1) is set forth in H-IV, 2 and C-IX, 1.4. These guidelines should be applied *mutatis mutandis* in the course of opposition proceedings in cases where the subject-matter of the European patent as granted or as amended during the opposition proceedings extends beyond the content of the application as filed.

## Chapter VI – Procedure for the examination of the opposition

(Oral proceedings: see E-II; taking and conservation of evidence: see E-III)

### 1. General remarks

The Opposition Division will first of all endeavour to reach a decision in written proceedings. Taking account of the investigations usually conducted beforehand by a primary examiner (see D-II, 5 and 6), the Opposition Division will base itself on the written submissions of the parties and, where appropriate, on other written evidence obtained, in particular, through the production of documents, requests for information and sworn statements in writing. In case oral proceedings are requested, see D-VI, 3.2.

The evidence should be submitted as soon as possible (see D-IV, 1.2.2.1).

However, if the Opposition Division considers it expedient, or if any party requests oral proceedings, oral proceedings in accordance with Art. 116(1) will be held before the Opposition Division after suitable preparation. In the oral proceedings, the parties may state their cases and put forward and argue submissions in order to clarify outstanding questions. Members of the Opposition Division may put questions to the parties.

*Art. 116*

In special, less common cases it will occasionally prove necessary in opposition proceedings for oral evidence to be taken by the Opposition Division as part of oral proceedings or for the conservation of evidence, or by a primary examiner outside the oral proceedings. The Opposition Division is not obliged to take oral evidence if it does not consider it necessary, even if a party has so requested. Oral evidence may be taken, where appropriate under oath, before the competent court in the country of residence of the person to be heard. A member of the Opposition Division may, at the request of the Opposition Division, attend such court hearings (see E-III, 1.3).

*Rules 117 to 120*

The principal means of taking oral evidence will be the hearing of witnesses and parties (see E-III, 1.6).

Only in exceptional cases will evidence be obtained at the initiative of the Opposition Division by means of oral and/or written reports by experts (see E-III, 1.8.1) or by carrying out an inspection (see E-III, 1.2, last paragraph). In view of the specialised knowledge of the members of the Opposition Division – and of the costs involved – such means should be used only as a last resort.

## **2. Adherence to the text of the European patent submitted or approved by the proprietor**

### **2.1 Basis for the examination**

*Art. 113(2)*

If the proprietor of the patent submits amendments to the description, claims or drawings after the notice of opposition has been communicated to him (see H-II, 3), the Opposition Division must take as a basis for its examination the text of the European patent submitted by the proprietor. This principle, that the Opposition Division must concern itself solely with the text most recently "submitted or agreed by the proprietor", also applies to the rest of the opposition procedure. (As regards the possibility of amending texts, see H-IV, 3.1, second paragraph.)

### **2.2 Revocation of the patent**

If the proprietor states that he no longer approves the text in which the patent was granted and does not submit an amended text, the patent must be revoked. This also applies when the proprietor requests that the patent be revoked.

## **3. Invitation to file observations**

### **3.1 Examiners' communications**

*Art. 101(1)*  
*Rule 81(2)*

In examining the opposition, the Opposition Division will invite the parties, as often as is necessary, to clarify the substance of the case, to file observations on communications from another party or issued by itself (see E-I, 1) and, where appropriate, to adduce evidence in respect of matters under dispute. Rule 81(2) does not require the Opposition Division to set a period for replying to this invitation. Such a period will, however, be set whenever the Opposition Division considers this expedient. As regards the length of the period see E-VII, 1.2, as regards the extension of a period see E-VII, 1.6 and as regards late submission of observations see E-VII, 1.7 and 1.8, as well as Art. 114(2).

*Rule 81(2)*

Communications from the Opposition Division and all replies thereto must be communicated to all parties.

### **3.2 Summons to oral proceedings**

*Art. 116(1)*  
*Rule 115(1)*

If oral proceedings have to be arranged, the parties must be summoned to them as quickly as possible at reasonable notice (see E-II, 6). If oral proceedings have been requested, the first substantive communication of the Opposition Division under Art. 101(1) is normally annexed to the summons to oral proceedings.

*Rule 116(1)*

Together with the summons, the Opposition Division will draw attention to and in the annexed communication explain the points which in its opinion need to be discussed for the purposes of the decision to be taken; where this has already been done sufficiently in a prior communication it is appropriate to refer to that communication. Normally, the annexed communication will also contain the



provisional and non-binding opinion of the Opposition Division on the positions adopted by the parties and in particular on amendments filed by the proprietor of the patent. At the same time, a date will be fixed up to which written submissions may be made or amendments meeting the requirements of the EPC may be filed. Normally this date will be one month before the date of the oral proceedings. However, an earlier date may be advisable if it is anticipated that a party will reasonably need more time, for example to consider the results of comparative tests filed by the other party. With respect to this date, Rule 132 does not apply, i.e. this time limit cannot be extended on request of the parties.

#### **4. Communications from the Opposition Division to the proprietor of the patent**

##### **4.1 Communications from the Opposition Division; reasoned statement**

Where necessary, any communication to the proprietor of the European patent should contain a reasoned statement. This also applies to any communication to other parties which is communicated to the proprietor of the patent for information only. A reasoned statement will usually not be required if the communication concerns only matters relating to form or if it contains no more than self-explanatory proposals. Where appropriate, all the grounds against the maintenance of the European patent are to be given in the communication.

*Rule 81(3)*

##### **4.2 Invitation to file amended documents**

If the Opposition Division considers that the European patent cannot be maintained in an unamended form, it must inform the proprietor of the patent accordingly, stating the grounds, and give him the opportunity to amend, in appropriate cases, the description, claims and drawings. As regards the time limit here, see E-VII, 1.2. Where necessary, the description adjusted in line with the new claims should also deal with the state of the art as set out in the opposition proceedings, the technical purpose and the advantages of the invention as it will then stand. However, if the proprietor has neither requested oral proceedings nor filed amendments (including any auxiliary requests), the patent can be revoked directly on the basis of the grounds, evidence and arguments on file (see also E-IX, 1.1).

*Rule 81(2) and (3)*

Proposals for amendment filed at a late stage in the proceedings may be disregarded (see T 406/86).

For amended documents, see H-III, 2.

#### **5. Additional search**

In exceptional cases, the Opposition Division, like the Examining Division, may on its own initiative cite new material relating to the state of the art and take it into account in its subsequent decision (see C-IV, 7.3). In the normal course of events, however, since the

grant of the patent will have been preceded by a search into the subject-matter of the application by the Search Division, by the Examining Division and generally by the opponents, no additional search will be made. Only in exceptional cases should an additional search by the Search Division be set in train. Such a case might arise, for example, if in the opposition the main subject covered by the patent shifts to elements of a dependent claim which were originally of subsidiary importance, to elements which were previously not set out in the claims, but only in the description, to individual features of a combination, or to sub-combinations, and there are grounds for believing that the original search did not extend to such elements or features and if no relevant document can be found quickly in the circumstances set out in C-IV, 7.3.

## **6. Examination of the opposition during oral proceedings**

For details regarding the examination shortly before and during oral proceedings and the conduct thereof, see E-II, 8.

## **7. Preparation of the decision**

### **7.1 General remarks**

If the Opposition Division does not consider it expedient to arrange for oral proceedings of its own motion (see E-II, 4) or for the taking of evidence even where the latter is requested (see E-III), and if no admissible request for oral proceedings has been received from a party (see E-II, 2), the decision must be reached on the basis of written proceedings. In this case there is no obligation to arrange for oral proceedings before a decision is reached.

If the case is decided on the basis of written proceedings, submissions filed after the decision has been handed over to the EPO internal postal service for remittal to the parties can no longer be considered, as from that moment the Division cannot amend the decision (see G 12/91), except to the limited extent provided for in Rule 140 (see H-VI, 5.1).

The decision, whether or not preceded by oral proceedings or the taking of evidence, may be to revoke the patent (see D-VIII, 1.2), to reject the opposition (see D-VIII, 1.3) or to maintain the patent as amended (see D-VIII, 1.4).

### **7.2 Preparation of a decision to maintain a European patent in amended form**

#### **7.2.1 Procedural requirements**

A decision to maintain the patent in amended form may be delivered only when the patent proprietor has approved the text in which the Opposition Division proposes to maintain the patent and the opponent has had sufficient opportunity to comment on the proposed new text.

*Art. 116(1)*  
*Rule 117*

*Art. 113*

Both prerequisites can be fulfilled during oral proceedings at which the Opposition Division establishes a complete text including the amended description and, if necessary, the amended figures. In written proceedings, the necessary opportunity to comment on the new text proposed by the Opposition Division can also be given to the opponent when a communication is issued to the parties. Once these requirements have been met, a separate communication under Rule 82(1) is neither necessary nor appropriate (see G 1/88).

If the patent can be maintained in the amended form, the Opposition Division should immediately try to obtain the patent proprietor's approval of the text in which the patent can be maintained and give the opponent an opportunity to comment on it. An interlocutory decision can then be delivered straight away.

If these requirements have still not been met and no oral proceedings are being held, a communication under Art. 101(1) must be issued. This also applies when it has been established in principle that the patent can be maintained in a particular form but a complete text expressly approved by the patent proprietor is not yet available.

The patent proprietor's approval of an amended version of the patent need not be given in a separate, express declaration; it may also be apparent from the circumstances, in particular from the fact that he has filed or requested the amended version. This applies equally to versions which have been filed as an auxiliary request. (For the wording of documents in oral proceedings, see E-II, 8.11 and 8.11.1.).

The patent proprietor's approval can also be obtained through a communication under Rule 82(1) in which the Opposition Division informs the parties that it "intends to maintain the patent as amended" and invites them to "state their observations within a period of two months if they disapprove of the text in which it is intended to maintain the patent". If the patent proprietor fails to file objections to the text thus notified, he is considered to approve of it.

*Rule 82(1)*

Generally speaking, this communication is useful only if the Opposition Division considers that the complete document expressly approved by the patent proprietor, on which the opponent has been able to comment, still requires amendments. However, these must not go beyond such editorial changes to the wording as appear absolutely necessary by comparison with the text most recently submitted or approved by the patent proprietor. The Opposition Division should draw attention to such amendments and state why they are required if they are not self-explanatory.

If within the period specified in the communication, or in a communication under Rule 82(1), the patent proprietor objects to the text in which the patent is to be maintained, the proceedings are continued. The European patent can be revoked in the subsequent proceedings if the patent proprietor objects to the text and fails to

submit new, properly amended documents despite having been requested to do so.

If an opponent objects to the text communicated to him in which it is intended to maintain the patent, the Opposition Division will continue examining the opposition if it considers that the EPC prejudices the maintenance of the patent in the text initially envisaged.

### **7.2.2 Decision on the documents on the basis of which the patent is to be maintained**

If the Opposition Division considers that the patent can be maintained on the basis of the text submitted or approved by the patent proprietor, and the opponent has had sufficient opportunity to comment on this text – either in writing or during oral proceedings – as well as on the reasons decisive to the patent's maintenance, the Opposition Division will issue an interlocutory decision to the effect that the patent and the invention to which it relates meet the requirements of the EPC following the amendments made by the patent proprietor during the opposition proceedings.

If the patent can only be maintained on the basis of an auxiliary request, the decision has to contain a reasoned statement why the version of the main request (and any preceding auxiliary request) does not meet the requirements of the EPC (see T 234/86).

A separate appeal under Art. 106(2) is allowed against this decision, which must be reasoned having regard to the grounds for opposition maintained by the opponent or taken up by the Opposition Division. The decision is delivered in all cases where a European patent is maintained in amended form, even if the opponent has approved of the text communicated by the Opposition Division or has not commented on it. In the former case, the decision is fairly brief, merely noting that in the light of the amended text the opponent no longer maintains his original grounds of opposition. If this decision is not contested, the ruling enshrined in it becomes final and as a result the documents can no longer be amended.

This interlocutory decision is intended to save the patent proprietor unnecessary translation costs arising from an amendment to the text in appeal proceedings.

### **7.2.3 Request for publishing fee and translations**

Once the interlocutory decision becomes final or the amended texts in which the patent is to be maintained have been drawn up in opposition appeal proceedings, the formalities officer requests the proprietor of the patent to pay, within three months, the fee for publishing a new specification of the European patent and to file a translation of any amended claims in the two official languages of the EPO other than the language of the proceedings.

*Rule 82(2)*

=====  
If the European patent in the amended form contains different claims for different Contracting States, a translation of all sets of claims – in the text communicated to the proprietor of the patent – into all official languages other than the language of the proceedings must be filed.

If the request under the first paragraph above is not complied with "in due time", the acts may still be validly performed within two months of notification of a communication pointing out the failure to observe the time limit, provided that within this two-month period the prescribed surcharge is paid. If any of the acts is not performed within the period of grace, the formalities officer will issue a decision for revocation of the patent in accordance with Rule 82(3).

*Rule 82(2) and (3)*  
*Art. 2, No. 9, RFees*



## Chapter VII – Details and special features of the proceedings

### 1. Sequence of proceedings

#### 1.1 Basic principle

Examination of the admissibility of the opposition and preparation of the examination of the opposition should be commenced immediately after the notice of opposition has been received by the formalities officer or the Opposition Division (see D-IV, 1 and 3 and D-V, 1 and 2).

If during the rest of the proceedings the Opposition Division, on account of the amount of work in hand, is unable to process immediately all the oppositions submitted, the reference date for the sequence of tasks will, in principle, be the date on which the last observations in respect of which a time limit had been laid down were submitted by any of the parties, but may not be later than the date on which the time limit expired. Documents received unsolicited or not subject to a previously stipulated official time limit, in connection with official communications setting a time limit, will not affect the sequence of tasks unless they require a further early notification setting a time limit.

#### 1.2 Exceptions

Notwithstanding D-VII, 1.1 above, oppositions are to be given priority:

- (i) if the earlier examination proceedings were of considerably longer duration than usual;
- (ii) if the opposition proceedings have already extended over a considerably longer period than usual;
- (iii) if a party to the proceedings has submitted a reasoned request for accelerated processing in a case where an infringement action in respect of the European patent is pending before a national court of a Contracting State, or if the EPO is informed by a national court or competent authority of a Contracting State that infringement actions are pending (Notice from the EPO dated 17 March 2008, OJ EPO 2008, 221);
- (iv) if other matters to be dealt with, e.g. divisional applications, hinge upon the final decision concerning the opposition; or
- (v) if the next procedural step can be dealt with relatively quickly.

### 2. Request for documents

Documents referred to by a party to opposition proceedings must be filed together with the notice of opposition or the written submissions. A single copy of these documents is sufficient. If such documents are

*Rule 83*

neither enclosed nor filed in due time upon invitation by the formalities officer, the Opposition Division may decide not to take any arguments based on them into account.

In implementing this provision the desired aim of speeding up the procedure should be borne in mind as much as the common interest in taking obviously relevant submissions into account.

*Rule 53(3)*

If during the opposition proceedings it becomes apparent that the previous application from which the opposed patent claims priority is not in an official language of the European Patent Office and the validity of the priority claim is relevant to the determination of the patentability of the subject-matter of the patent concerned, the Opposition Division will invite the proprietor of the European patent to file a translation of that application into one of the official languages within a period to be specified. Alternatively, a declaration may be submitted that the European patent application on the basis of which the opposed patent was granted is a complete translation of the previous application. For the procedure for inviting the patent proprietor to file such a translation or declaration see A-III, 6.8 and F-VI, 3.4. Such an invitation is not to be issued if the translation of the previous application or the declaration was available to the European Patent Office and is to be included in the file of the European patent application under Rule 53(2).

Failure by the proprietor of the European patent to supply a required translation or declaration in due time will lead to the priority right being lost. This will have the effect that the intermediate document(s) which resulted in the validity of the priority claimed becoming relevant for the assessment of patentability will belong to the prior art under Art. 54(2) or Art. 54(3), as applicable (see A-III, 6.8.3). The proprietor will be notified of this loss of rights (see A-III, 6.11). As a means of redress he may request either re-establishment of rights under Art. 122 and Rule 136 (see E-VII, 2.2) or a decision under Rule 112(2) (see E-VII, 1.9.3).

### **3. Unity of the European patent**

#### **3.1 Basic principle**

*Art. 118*

If the proprietors of the patent are not the same for different designated Contracting States, the unity of the European patent in opposition proceedings will not be affected, since such persons are to be regarded as joint proprietors (see D-I, 6, second and third paragraphs).

In particular, the text of the European patent will be uniform for all designated Contracting States unless otherwise provided for in the EPC (see D-VII, 3.2 and H-III, 4).



### 3.2 Factors affecting the unity of the European patent

The unity of the European patent in opposition proceedings will be affected if the previous proprietor of the patent and the person replacing him pursuant to Art. 99(4) in respect of a particular Contracting State are not deemed to be joint proprietors (see D-I, 6). In this event, the opposition proceedings involving the different proprietors must be conducted separately. Since different requests may be submitted by the two proprietors (e.g. as regards amendments to the claims), the two sets of opposition proceedings may lead to different conclusions, e.g. as regards the text of the European patent or the scope of protection.

## 4. Procedure where the proprietor is not entitled

### 4.1 Stay of proceedings

If a third party provides proof, e.g. a certificate from the court concerned, to the EPO during opposition proceedings or during the opposition period that he has opened proceedings against the proprietor of the European patent for the purpose of obtaining a decision within the meaning of Art. 61(1), the Opposition Division must stay the opposition proceedings unless the third party consents to their continuation. Such consent must be communicated in writing to the EPO and is irrevocable. However, the proceedings will be stayed only if the Opposition Division has deemed the opposition admissible.

*Rule 78(1)*

If proceedings within the meaning of Art. 61(1) are instituted during the opposition period, a stay of proceedings will be possible only if a notice of opposition has been filed. Accordingly, the third party might have to file an opposition itself in order to benefit from a stay of proceedings under Rule 78.

The dates of stay and resumption of proceedings will be entered in the European Patent Register. The parties to the opposition proceedings are to be informed of the order staying the proceedings.

#### 4.1.1 Date of the stay of proceedings

The proceedings are stayed on the date on which the EPO receives evidence that proceedings against the patent proprietor have been instituted. The requirements for valid institution of relevant proceedings are determined by national law (J 7/00).

#### 4.1.2 Legal character and effect of the stay of proceedings

Stay of proceedings is a preliminary procedural measure “sui generis” which takes immediate effect as a preventive measure to preserve the third party’s possible rights (J 28/94; J 15/06).

The patent proprietor will not be heard but may file a request for an appealable decision on the stay of proceedings.

Stay of proceedings means that the legal status quo existing at the time of ordering is maintained, i.e. neither the EPO nor the parties may validly perform any legal acts (J 38/92).

An automatic debit order ceases to be effective on the day on which a stay of the proceedings takes effect (see Point 13(e) AAD, Annex A.1 to the ADA, Supplementary publication 4, OJ EPO 2014, 24). If the automatic debiting procedure is to be used again after resumption of the proceedings, a new automatic debit order is to be filed.

## 4.2 Continuation of proceedings

The date of the continuation of the proceedings and the legal basis for their continuation are to be communicated to the parties to the opposition proceedings.

### 4.2.1 Continuation after a final decision

*Rule 14(2)*  
*Rule 78(1)*

Proceedings are resumed when evidence is provided that a final decision within the meaning of Art. 61(1) has been taken. If the decision is in favour of the third party, the proceedings may not be resumed earlier than three months after the decision has become final, unless the third party requests resumption.

### 4.2.2 Continuation regardless of the stage reached in national proceedings

*Rule 14(3)*  
*Rule 78(1)*

When giving a decision on the stay of proceedings or thereafter, the Legal Division may set a date on which it intends to continue the proceedings, regardless of the stage reached in the national proceedings.

Unlike the decision on staying the proceedings, it is at the discretion of the Legal Division to decide whether proceedings are to be resumed. In exercising this discretion, the Legal Division has to take into account the impact of a further suspension or the continuation of the proceedings on each of the parties (J 33/03). Some aspects to be taken into account when exercising this discretion are the duration of the stay and the outcome of first-instance proceedings before national courts. Likewise, it should be considered whether delaying tactics are being employed by the third party.

## 4.3 Interruption of time limits

*Rule 14(4)*  
*Rule 78(1)*

The time limits in force at the date of stay other than time limits for payment of renewal fees are interrupted by the stay of proceedings. The time which has not yet elapsed begins to run as from the date on which proceedings are resumed; however, the time still to run after the resumption of the proceedings must not be less than two months.

Example: The three-month time limit under Rule 82(2) begins on 4 January 2012; proceedings are stayed on 24 January 2012 and resumed on 26 September 2012. Of the first month (ending 3 February 2012) there are still 11 days left (24 January -

3 February). The total time which has not elapsed then amounts to 11 days and 2 months.

⊥ The time limit ends on 6 December 2012.

#### 4.4 Department responsible

⊥ The Legal Division is responsible for the procedure where the proprietor is not entitled (see the Decision of the President of the EPO dated 21 November 2013, OJ EPO 2013, 600). *Art. 20*

### 5. Continuation of the opposition proceedings in the cases covered by Rule 84

#### 5.1 Continuation in the case of surrender or lapse of the patent

If the European patent has been surrendered or has lapsed for all the designated States, the opposition proceedings may be continued at the request of the opponent filed within two months after the date on which the Opposition Division informed the opponent of the surrender or lapse. Evidence of the lapse must generally be provided by submitting extracts from the Patent Registers of the designated Contracting States. *Rule 84(1)*

Surrender or lapse has immediate non-retroactive effect (i.e. patent protection ceases on the date of surrender or lapse), whereas a revoked patent is deemed to have had no effect from the outset (Art. 68). So the opponent may still have an interest in the revocation of a lapsed or surrendered patent.

If, in the case of a request for continuation of the proceedings, the proprietor of the patent has renounced before the competent authorities in the designated states all rights conferred by the patent with *ab initio* and universal effect, or if no request for continuation has been received within the time limit, the opposition proceedings will be closed. The decision to close the proceedings will be communicated to the parties.

⊥ A statement by the proprietor making it unambiguously clear that he no longer wishes his patent to be maintained is considered to be a request for its revocation, irrespective of the wording used (T 237/86). For details of the procedure to be followed, see D-VIII, 1.2.5.

#### 5.2 Continuation on the death or legal incapacity of the opponent

In the event of the death or legal incapacity of an opponent, the opposition proceedings may be continued by the Opposition Division of its own motion, even without the participation of the heirs or legal representatives, for example if the legal proceedings in connection with the will or the appointment of a new legal representative would inordinately prolong the opposition proceedings. This provision will apply not only where only one opposition has been filed: it will also *Rule 84(2)*

apply in cases where not all those who have filed opposition are deceased or legally incapacitated.

The Opposition Division should continue the proceedings if, for instance, the proprietor of the patent has submitted amendments to the patent in response to the notice of opposition (see T 560/90). The Opposition Division should also continue the proceedings if it considers that the stage reached in the opposition proceedings is such that they are likely to result in a limitation or revocation of the European patent without further assistance from the opponent(s) concerned and without the Opposition Division itself having to undertake extensive investigations (see T 197/88).

The proprietor of the patent and any other parties are to be informed that the proceedings will be continued. Otherwise the proceedings are closed and the decision to close the proceedings is communicated to the parties.

### **5.3 Continuation after the opposition has been withdrawn**

*Rule 84(2)*

The opposition proceedings can be continued even if every opposition has been withdrawn. The principles set forth in D-VII, 5.2 apply *mutatis mutandis* in deciding whether the proceedings are to be continued or closed.

### **6. Intervention of the assumed infringer**

*Art. 105*  
*Rule 89*

The assumed infringer of a patent (see D-I, 5) may file notice of intervention in the opposition proceedings within three months of the date on which infringement proceedings were instituted against him or on which he instituted proceedings for a court ruling that he is not infringing the patent. Notice of intervention must be filed in a written reasoned statement. It is not deemed to have been filed until the opposition fee has been paid in the amount prescribed in the Rules relating to Fees under the EPC.

Intervention is permissible as long as opposition or appeal proceedings are pending. A third party can become a party to the proceedings during the period for filing an appeal only if a party to the proceedings in which the decision was given files an appeal pursuant to Art. 107; otherwise the decision of the Opposition Division will become final on expiry of the appeal period (see G 4/91 and G 1/94 ).

A properly filed and admissible intervention is treated as an opposition, which may be based on any ground of opposition under Art. 100 (see G 1/94). This means that, when intervening at any stage of first-instance proceedings, the intervener enjoys essentially the same rights as any other party to the proceedings. If the intervener introduces new facts and evidence which appear to be crucial, the proceedings may need to be prolonged to enable them to be adequately considered. In all other cases the Opposition Division must ensure that the intervention does not delay the proceedings.

If the notice of intervention is filed at a late stage of the proceedings, for example when oral proceedings have already been scheduled, the Opposition Division may dispense with issuing communications under Rule 79(1) to (3). The introduction of a new ground for opposition at such a late stage may lead to a postponement of the date set for oral proceedings. *Rule 79(4)*

For accelerated processing of oppositions and accelerated processing before the Boards of Appeal on request, see E-VII, 4 and 5.

The notice of intervention, filed in a written reasoned statement, must contain: *Rule 89(2)*

- (i) a statement of the grounds for intervention and corresponding evidence *Art. 105(1)*
- (ii) the name, address and nationality of the assumed infringer and the State in which his residence or principal place of business is located. Names of natural persons must be indicated by the person's family name and given name(s), the family name being indicated before the given name(s). Names of legal entities, as well as companies considered to be legal entities by reason of the legislation to which they are subject, must be indicated by their official designations. Addresses must be indicated in such a way as to satisfy the customary requirements for prompt postal delivery at the indicated address. They must comprise all the relevant administrative units, including the house number, if any. Assumed infringers (whether natural or legal persons) whose residence or principal place of business is in an EPC contracting state and who act without a professional representative can use an address for correspondence other than their residence. The address for correspondence must be the assumed infringer's own address. Post cannot be sent to a different (natural or legal) person, since that requires a valid form of representation under Art. 133 and 134. It is recommended that the telephone and fax number be indicated (see D-IV, 1.2.2.2(i) and 1.4.2); *Rule 76(2)(a)*  
*Rule 41(2)(c)*
- (iii) the number of the European patent at issue in the opposition proceedings in which intervention is made, the name of the proprietor and the title of the invention (see D-IV, 1.2.2.2(ii) and 1.4.2); *Rule 76(2)(b)*
- (iv) a statement of the extent to which the European patent at issue is opposed by way of intervention and of the grounds on which the opposition by way of intervention is based, as well as an indication of the facts and evidence presented in support of these grounds, together with a statement of reasons, i.e. arguments (see D-IV, 1.2.2.1(iii) to (v) and 1.4.2); *Rule 76(1)*  
*Rule 76(2)(c)*

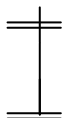

*Rule 76(2)(d)* (v) if the assumed infringer has appointed a representative, his name and the address of his place of business in accordance with sub-paragraph (ii) as set out above (see D-IV, 1.2.2.2(iii) and 1.4.2).

*Rule 77(1)* D-IV, 1, sets out further details and explains how to deal with the intervention if one of these requirements is not fulfilled.

### **7. Publication of a new specification of the patent**

*Art. 103* If a European patent is maintained in an amended form, the EPO must, as soon as possible after it publishes the mention of the opposition decision, publish a new specification of the European patent containing the description, the claims and any drawings, in the amended form.

*Rule 87* Rule 74 applies *mutatis mutandis* to the new specification of the European patent.

### **8. Transitional provisions for Art. 54(4) EPC 1973 and Art. 54(5)**

Art. 54(4) EPC 1973 and Rule 23a EPC 1973 continue to apply to patents granted in respect of patent applications filed before 13 December 2007. Consequently, in such cases, the designated countries need to be taken into consideration when assessing the novelty of documents according to Art. 54(3) (see H-III, 4.2).

Art. 54(5) applies only to patents for which the date of the decision to grant the patent under consideration was taken on or after 13 December 2007 (Special edition No. 1, OJ EPO 2007, 197). If the decision to grant was taken before that date (the date of entry into force of EPC 2000), only "Swiss-type" claims are allowed for any second or further medical use (provided these claims meet with all the other requirements of the Convention).

Where the subject-matter of a claim is rendered novel only by a new therapeutic use of a medicament, that claim may no longer take the form of Swiss-type claim for European or international patent applications having a filing date or earliest priority date of 29 January 2011 or later (see G 2/08, OJ EPO 2010, 514, and G-VI, 7.1).

## Chapter VIII – Decisions of the Opposition Division

General remarks on decisions appear in E-IX.

### 1. Final decisions on an admissible opposition

#### 1.1 General remarks

The Opposition Division has to take a final decision on the opposition, by revoking the European patent or rejecting the opposition or ruling that the European patent is to be maintained as amended. If the only admissible opposition or all the admissible oppositions are withdrawn and the Opposition Division takes the view that as the case stands there is no reason for the Office to continue the proceedings of its own motion, the proceedings are closed by means of a formal decision (Rule 84(2), second sentence).

#### 1.2 Revocation of the European patent

##### 1.2.1 Revocation on substantive grounds

If the Opposition Division is of the opinion that at least one ground for opposition as set out in Art. 100 prejudices the maintenance of the European patent, it will revoke the patent under Art. 101(2), first sentence. Analogously, if the Opposition Division is of the opinion that the patent as amended during the course of the opposition proceedings does not meet the requirements of the Convention, it will revoke the patent under Art. 101(3)(b).

*Art. 101(2)*

*Art. 101(3)(b)*

For revocation because the proprietor of the patent has not given his agreement to the text, see D-VI, 2.2 and D-VIII, 1.2.5.

##### 1.2.2 Revocation for failure to pay the prescribed fee for publishing or to file a translation

If the proprietor of the patent fails in due time to pay the prescribed fee for the printing of a new specification of the European patent or to file a translation of the amended claims in the two official languages of the EPO other than the language of the proceedings (see D-VI, 7.2.3), the European patent will be revoked.

*Rule 82(3)*

##### 1.2.3 Revocation for failure to notify the appointment of a new representative

If opposition proceedings are interrupted according to Rule 142(1)(c) and the patent proprietor, who is not resident in one of the Contracting States, does not forward a notification of the appointment of a new representative within the two-month period laid down in Rule 142(3)(a) (see E-VI, 1.4(i)), the European patent will be revoked.

*Rule 142(3)(a)*



#### **1.2.4 Revocation in the event of requirements not being met until after expiry of time limits**

In the cases referred to in D-VIII, 1.2.2 and 1.2.3, the European patent will be revoked even if the omitted acts have been completed during the period between expiry of the time limit and the taking of a final decision, unless a request for re-establishment of rights has been filed, in which case a decision must first be given on the application.

#### **1.2.5 Revocation of the patent in the event that the proprietor no longer wishes the patent to be maintained as granted**

If the proprietor states that he no longer approves the text in which the patent was granted and does not submit an amended text, the patent must be revoked. This also applies when the proprietor requests the patent to be revoked.

If a proprietor unambiguously declares to the EPO the surrender (or abandonment or renunciation) of the patent, this is interpreted as equivalent to a request that the patent be revoked (see T 237/86). If the request of the proprietor is not unambiguous, he is given the opportunity to request that the patent be revoked or to declare that he no longer approves of the patent being maintained as granted. This results in the patent being revoked.

#### **1.3 Rejection of the opposition**

*Art. 101(2)*

If the Opposition Division is of the opinion that the grounds for opposition mentioned in Art. 100 do not prejudice the maintenance of the European patent unamended, it will reject the opposition.

#### **1.4 Maintenance of the European patent as amended**

##### **1.4.1 Taking of a final decision**

*Art. 101(3)(a)*

*Rule 82(1) and (2)*

If the Opposition Division is of the opinion that, taking into consideration the amendments made by the proprietor of the patent during the opposition proceedings, the patent and the invention to which it relates meet the requirements of the EPC, it will issue a decision to maintain the European patent as amended.

The procedure specified in D-VI, 7.2.1 to 7.2.3 will precede the decision.

##### **1.4.2 Statement in the decision of the amended form of the European patent**

*Rule 82(4)*

The decision must state which text of the European patent forms the basis for maintaining it.



## **2. Other decisions**

### **2.1 Decision on the inadmissibility of an opposition or intervention**

See D-IV, 3 and 5.5 with reference to the notice of opposition and D-IV, 5.6 and D-VII, 6 for the intervention of an assumed infringer.

### **2.2 Decisions which do not terminate proceedings**

Such decisions are dealt with in E-IX, 6.

See D-VI, 7.2.2 with reference to the maintenance of a patent with amended documents.

### **2.3 Decision on a notified loss of rights at the request of the person concerned**

This decision is dealt with in E-VII, 1.9.3.

*Rule 112(2)*

### **2.4 Decision on re-establishment of rights**

This decision is dealt with in E-VII, 2.2.7.

### **2.5 Decision on closure of the opposition proceedings**

This decision is dealt with in D-VII, 5 and D-VIII, 1.1.



## Chapter IX – Costs

### 1. Charging of costs

#### 1.1 General principle

Each party to the proceedings must bear the costs it has incurred. *Art. 104(1)*  
However, an Opposition Division may, for reasons of equity, order a different apportionment of such costs, which may have been incurred during the taking of evidence, in oral proceedings or under other circumstances.

The phrase "taking of evidence" refers generally to the receiving of evidence by an Opposition Division, whatever the form of such evidence. It includes among other things the production of documents and sworn statements in writing as well as hearing witnesses (see T 117/86).

#### 1.2 Decisions on the apportionment of costs

Apportionment of costs must be dealt with in the decision on the opposition. This apportionment will form part of the main decision and will be incorporated in the operative part of the decision. *Rule 88(1)*

The decision will deal only with the obligation on the party or parties concerned to bear costs. The actual amounts to be paid by one party to another must be dealt with in the decision on the fixing of costs (see D-IX, 2).

A statement that the parties will bear their own costs may be incorporated in the grounds for the decision on the opposition and should be included in cases where one of the parties to the proceedings has submitted a request for a decision on the apportionment of costs which the Opposition Division does not consider justified.

A decision to apportion costs may be made by the Opposition Division of its own motion, even if no application for the apportionment of costs has been made.

In the absence of an express decision on the apportionment of costs, each of the parties concerned must bear his own costs.

#### 1.3 Costs to be taken into consideration

Apportionment of costs may relate only to those expenses necessary to assure proper protection of the rights involved. *Rule 88(1)*

Examples of such expenses are:

*Art. 104(1)*

- (i) expenditure incurred in respect of witnesses and experts, together with other costs arising in connection with the taking of evidence;

- (ii) remuneration of the representatives of the parties in respect of oral proceedings or the taking of evidence;
- (iii) remuneration of the representatives of the parties in respect of undue delaying of the procedure by one of the parties or in respect of the late filing of documents; and
- (iv) expenditure incurred directly by the parties, i.e. their travel expenses in coming to oral proceedings or the taking of evidence.

Costs incurred in respect of superfluous or irrelevant evidence, etc., cannot be covered by a decision on costs.

#### **1.4 Principle of equity**

Reasons of equity will require a decision on the apportionment of costs when the costs arise in whole or in part as a result of conduct of one party which is not in keeping with the care required to assure proper protection of the rights involved, in other words when the costs are culpably incurred as a result of irresponsible or even malicious actions. Each party may of course defend his rights or interests (e.g. the proprietor his patent) by any legally admissible means within the framework of the opposition proceedings; he may, for example, request oral proceedings or the taking of evidence.

Accordingly, costs incurred as a result of default or of inappropriate legal means used by either party may be charged to the party responsible, even if he has been successful in the opposition proceedings.

The following are examples where the principle of equity may be applied:

The costs incurred by the opponent in preparing oral proceedings which have been appointed may be charged to the proprietor of the patent if he surrenders the patent just before the date appointed for the oral proceedings, although it was clear when the proceedings were being arranged, from a document put forward by the opponent, that the proprietor of the patent had no case and he alone therefore was liable for his irresponsible conduct.

If an aspect of the state of the art is adduced as an argument at a late stage and it can be shown, or it is evident, that the party concerned knew of it earlier, e.g. in that he had made prior use of it, the additional costs of further oral proceedings unnecessarily incurred by the other parties may be charged to the party which caused them by submitting his argument at so late a stage.

If relevant facts or evidence are submitted by a party only at a late stage of the proceedings without any good reason and if, as a consequence, unnecessary costs are incurred by another party, the Opposition Division may decide on the apportionment of costs.

## **2. Procedure for the fixing of costs**

### **2.1 Fixing of costs by the Opposition Division**

At the request of at least one party, the Opposition Division must fix the amount of the costs to be paid under a decision apportioning them. The request is admissible only if the decision apportioning the costs has become final. *Art. 104(2)*  
*Rule 88(2)*

A bill of costs, with supporting evidence in respect of each amount involved, must be attached to the request. Costs may be fixed once their credibility is established. *Rule 88(2)*

The parties will be notified of the costs as fixed by the Opposition Division. *Art. 119*

For the allocation of the duty of fixing the costs, see D-II, 7.

### **2.2 Appeal against the fixing of costs by the Opposition Division**

The fixing of costs by the Opposition Division may be reviewed by a decision of the Opposition Division.

The request for such a decision, stating the reasons on which it is based, must be filed with the EPO in writing within one month after the date of notification of the fixing of costs by the Opposition Division. It is not deemed to be filed until the fee for the awarding of costs has been paid at the rate prescribed in the Rules relating to Fees under the EPC. *Rule 88(3)*

The Opposition Division will take a decision on the request without oral proceedings. *Rule 88(4)*

## **3. Enforcement of the fixing of costs**

Any final decision of the EPO fixing the amount of costs must be dealt with, for the purpose of enforcement in the Contracting States, in the same way as a final decision given by a civil court of the State in the territory of which enforcement is to be carried out. Verification of any such decision must be limited to its authenticity. *Art. 104(3)*

"Decision" as referred to above also covers the final fixing of costs by the Opposition Division.



## Chapter X – Limitation and revocation procedure

### 1. Introduction

The limitation and revocation procedures are centralised *ex parte* procedures at the level of the EPO which allow the patent proprietor either to have the claims of his granted patent limited or to have the whole patent revoked for all the designated states. More particularly, the limitation procedure offers an opportunity to obtain a limitation of a European patent in a short and straightforward procedure.

Unlike in the opposition procedure, there is no restriction on the period between the grant of the patent and the filing of the request. Accordingly, the request can be filed at any time after grant, after opposition proceedings, or even after expiry of the patent.

Certain aspects of this procedure are entrusted to formalities officers (see the Decision of the President of the EPO dated 12 December 2013, OJ EPO 2014, A6).

### 2. Examination for deficiencies in the request

#### 2.1 Deficiencies which lead to the request being deemed not to have been filed

On receipt of a request for revocation or limitation of a patent, the formalities examiner will examine whether: *Art. 105a*

- (i) the request is filed with the EPO (Art. 105a(1))
- (ii) opposition proceedings in respect of the patent are not pending at the time of filing the request (Art. 105a(2) and Rule 93(1))
- (iii) the relevant fee is paid (Art. 105a(1) and Art. 2, No. 10a, RFees)
- (iv) where the request is filed in a language according to Art. 14(4), the translation has been filed in due time (Rule 6(2))
- (v) where the requester is required by Art. 133(2) to appoint a representative, this was done in due time (Rule 152 (3) and (6)).

If any of these requirements are not met, the request is deemed not to have been filed. This finding is notified to the requester (Art. 119), and the fee is refunded.

Otherwise, the request is considered to have been filed, and the limitation/revocation procedure commences.

## **2.2 Deficiencies which, if not remedied, lead to the request being rejected as inadmissible**

### *Rule 92*

The formalities officer will furthermore examine whether:

- (i) the request is filed in writing (Rule 92(1))
- (ii) the request includes the particulars of the requester required by Rule 92(2)(a), referring to Rule 41(2)(c)
- (iii) the request indicates in which Contracting States the requester is the proprietor of the patent (Rule 92(2)(a))
- (iv) the request indicates the number of the patent to be limited or revoked (Rule 92(2)(b))
- (v) the request indicates in which Contracting States the patent has taken effect, even if in the meantime it has lapsed in one or more of those Contracting States (Rule 92(2)(b))
- (vi) in cases (iii) and (v), and if the requester is not the proprietor for all these Contracting States, the requester provides the names and addresses of the other proprietors, and evidence that he is entitled to act on their behalf (Rule 92(2)(c)); due to the retroactive effect of a limitation/revocation (Art. 68), such evidence is required also in the case where the patent has lapsed in one or more of the Contracting States referred to under (v) in the meantime. Note that in the case of joint proprietors, whether for the same or different Contracting States, the requirements of Rule 151 for appointment of a common representative also apply in the limitation or revocation procedure (see A-VIII, 1.3).
- (vii) where limitation is sought, the request includes the complete version of the amended claims (and of the description and drawings where applicable) (Rule 92(2)(d))
- (viii) if the requester has appointed a representative, the particulars according to Rule 41(2)(d) (Rule 92(2)(e)) have been filed.

### *Rule 94*

If any of the above requirements are not met, the requester is invited to correct the deficiencies within a period to be specified.

If the deficiencies are not corrected within this period, the request is to be rejected as inadmissible. This decision is notified to the requester (Art. 119). Re-establishment of rights under Art. 122 is, however, available. The decision rejecting the request is open to appeal (Art. 106(1)).

Otherwise, the request is deemed admissible.



### 3. Decision on request for revocation

If the request is for revocation, and is admissible, the Examining Division will revoke the patent and communicate this to the requester (Art. 105b(2) and Rule 95(1)). The decision takes effect on the date on which it is published in the Bulletin (Art. 105b(3)). In accordance with Art. 68, the effect of the decision is that the patent is revoked *ab initio*, conferring no rights under Art. 64 or 67. As stated in Art. 105b(3), the decision applies to all Contracting States in respect of which the patent was granted. It is not possible for the patent to be revoked only for some Contracting States, and not for others.

Art. 105b(2)

Rule 95

### 4. Substantive examination (limitation)

#### 4.1 Department responsible

If a request for limitation is deemed to be admissible, then the file will be forwarded to the Examining Division, as the department responsible for the examination of the request.

Rule 91

#### 4.2 Basis for the examination

The basis for the examination is the patent as granted or amended in opposition or limitation proceedings (Rule 90). In cases in which there have already been both opposition and limitation procedures, or more than one limitation procedure, the basis for the examination is the patent as amended in the most recent of those procedures.

Rule 90

The requester has the option of providing information (with the request, or later in the procedure) as to why the request is allowable, and/or as to the purpose behind the request, but he is not obliged to do so. The purpose underlying the request is, however, of no relevance to the question whether it is allowable.

#### 4.3 Scope of the examination

The scope of the examination is limited by Rule 95(2). The Examining Division is required to decide only whether the amended claims of the request constitute a limitation with respect to the claims as granted or amended (i.e. those referred to in D-X, 4.2), and whether the amended claims comply with the requirements of Art. 84 and Art. 123(2) and (3).

Rule 95(2)

The term "limitation" is to be interpreted as meaning a reduction in the extent of protection conferred by the claims. Mere clarifications or changes made to protect a different subject ("*aliud*") are not to be considered as limitations.

More particularly, the limitation of a dependent claim only, without any independent claim being limited, is acceptable. However, it is not permissible to introduce non-limiting amendments in the description or in the claims that are not a consequence of the limitation of the claims (for example tidying up unclear claims, making amendments to improve the patent or cosmetic changes). Likewise, adding

dependent claims in limitation is not permissible if not directly caused by the limitation introduced in the claims.

Amendments in a claim leading to an extent of protection which is smaller, but falls partly outside the extent of protection conferred by the claim previously on file, should be dealt with cautiously. Even if the amendment constitutes a limitation, such a claim would generally contravene Art. 123(3) (see also H-V, 7 for Art. 123(3) in the case of a change of category of a claim).

*Art. 69(1)*

For interpretation of Art. 84 and Art. 123(2), see F-IV, 4, and H-IV, 4.4. The description and drawings are used to interpret the claims in accordance with Art. 69(1) and its Protocol on Interpretation. Amendments made to these parts might therefore introduce matter contrary to Art. 123(3) (see H-IV, 3.1 and 3.3).

*Rule 139*

Errors of transcription or obvious mistakes can, however, be rectified on request or by the EPO of its own motion.

The filing of auxiliary requests together with a main request is possible (see H-III, 3).

#### **4.4 Further stages of the examination**

If the examination under D-X, 4.3 above leads to the conclusion that the request is allowable, then the next stage of the procedure - the establishment of the formal requirements for limitation as described under D-X, 5 can begin. Otherwise, in accordance with Rule 95(2), a communication must be sent to the requester identifying the deficiencies and giving him the opportunity to correct them within a period to be specified. The normal period is two months (Rule 132(2)). It is, in principle, extendable, but only under exceptional circumstances.

The examiner may not adapt the description of his own motion (see D-X, 5). In case of discrepancy between the claims and the description, he will always raise an objection.

If the requester responds in due time in a manner such that no objections remain, then the procedure continues as in D-X, 5.

Rule 95(2) provides for only one opportunity to make amendments during limitation. However, if the response to the communication under Rule 95(2) overcomes the objections raised in that communication, but gives rise to new objections, the fundamental principle of the right to be heard under Art. 113(1) will normally make a further communication necessary in order to communicate the new objections to the requester before the decision to reject the request for limitation is issued (see D-X, 6). Normally, no further amendments may be made in reply to that communication.

Rule 95(2) specifies that the Examining Division must give the requester one opportunity to correct the deficiencies. However, any request for oral proceedings according to Art. 116 must be granted if the request for limitation is not allowable. No further amendments may be submitted during oral proceedings if the opportunity to make amendments has already been taken.

#### **4.5 Third-party observations during the examination**

Art. 115 explicitly covers all proceedings before the EPO, not just pre-grant proceedings. Accordingly, its provisions also apply in principle to revocation and limitation proceedings. Patentability under Art. 115 is to be interpreted in a broader sense, so that issues relating to Art. 84 and Art. 123(2) may also be taken into consideration. The requester could, when responding to an invitation under Rule 95(2), introduce further restrictions intended to address such observations. If he wishes to do this, and no invitation under Rule 95(2) is issued, his only option is to file a further request for limitation.

*Art. 115*  
*Rule 114*

#### **5. Formal procedure for limitation when the request is allowable**

If the request for limitation is allowable, then according to Rule 95(3) the Examining Division must communicate this to the requester and invite him to pay the prescribed fee and file translations of the amended claims into the other two official languages within a period of three months.

*Rule 95(3)*  
*Art. 2, No. 8 and*  
*No. 9, RFees*

The nature of the communication under Rule 95(3) inviting the requester to pay the prescribed fee and file translations of the claims is different from the communication of the intention to grant during examination proceedings under Rule 71(3). During limitation, the text filed by the requester is deemed to be approved, whereas at this stage in examination the text is a version proposed to the applicant and subject to his approval.

Once the requester has received the communication under Rule 95(3), he can only pay the fee and file the translations or have his request rejected for failure to do so. Therefore the Examining Division may not, with the communication under Rule 95(3), make amendments of its own motion to the claims of a request for limitation in order to render them allowable or adapt the description of its own motion to the limited claim(s). The provisions of Art. 113 would not be met, since the requester does not have an opportunity to contest or comment on the amendments made.

As in opposition proceedings, the requester benefits from a two-month period of grace for reply with payment of a surcharge (Art. 2, No. 9, RFees). Re-establishment of rights is available.

If the requester pays the fee and files the required translations in due time, the Examining Division will decide to limit the patent

*Art. 105b(2) and (3)*

(Art. 105b(2) and Rule 95(3), last sentence). This takes effect on the date on which the mention of the decision is published in the Bulletin.

*Art. 105c* As soon as possible after this, the amended specification will be published by the EPO. The form of publication of the amended patent specification is defined in Rule 96, Rule 73(2) and (3) and Rule 74. The procedure for this is the same as in opposition proceedings.

*Art. 68* As for revocation (see D-X, 3), the effect of the decision to limit the patent is that the patent is limited *ab initio*.

## 6. Rejection of the request

If:

- (i) the requester does not respond in due time to the invitation under Rule 95(2) (see D-X, 4.4 above); or
- (ii) he responds in due time, but the request is still not allowable; or
- (iii) he fails to pay the fee(s) and file the translation according to Rule 95(3) (see D-X, 5 above),

then the Examining Division will reject the request (Art. 105b(2), last sentence and Rule 95(4)), provided the requirements of Art. 113(1) are met (see D-X, 4.4).

The decision to reject the request will be notified in accordance with Art. 119 to the requester.

*Rule 111(2)*  
*Art. 106(1)* In case (ii), the decision is a reasoned decision taken by the Examining Division, and is subject to appeal.

## 7. Relation to opposition proceedings

### 7.1 Precedence of opposition proceedings

*Rule 93(1)* The case in which opposition proceedings are already pending when the request for revocation or limitation is filed has been mentioned in D-X, 2.1. In the opposite case, i.e. where an opposition is filed while revocation or limitation proceedings are pending, the procedure depends on whether the pending proceedings relate to a request for revocation or for limitation.

*Rule 93(2)* According to Rule 93(2), if the pending proceedings relate to a request for limitation, the Examining Division will terminate those proceedings and order the reimbursement of the limitation fee. The limitation procedure is terminated on the day the decision on the limitation procedure is handed over to the internal EPO postal service. If the requester has already paid the fee referred to in Rule 95(3) (see D-X, 5), this fee will also be refunded. The opposition procedure will then continue in the normal manner.

The decision to terminate the limitation proceedings is notified to the requester (Art. 119).

Rule 93(2) is restricted to limitation proceedings. Therefore, in the case of revocation proceedings, there is no precedence of opposition. Revocation proceedings continue after an opposition is filed, and the case proceeds to opposition only if the request for revocation is deemed not to have been filed, is rejected as inadmissible or is withdrawn. Otherwise, if the patent is revoked, the opponent(s) will be informed of this situation and the opposition proceedings will be terminated.

## **7.2 Filing of opposition after decision on limitation**

On rare occasions it may happen that the limitation procedure is finished before an opposition is filed within the nine-month period and the decision to limit has already been published in the European Patent Bulletin. In such cases the opponent does not benefit from a new nine-month period, since the opposition period runs only once from publication of the mention of the grant of the patent. Accordingly the opponent will not have a full nine-month period to formulate the opposition for the patent as limited.

## **8. Legal status of decisions**

The decisions rejecting the request for limitation or revocation as either inadmissible or not allowable (see D-X, 2 and 6) are open to appeal, as they are decisions of the Examining Division terminating a procedure. Accordingly they are decisions listed as such in Art. 21(3)(a).

*Art. 106(1)*

## **9. Withdrawal of the request**

In the absence of any provision to the contrary and in accordance with normal legal principles, the requester may withdraw his request for limitation or revocation at any time, provided that the request is still pending. In this case, however, the limitation or revocation fee will not be refunded.

## **10. Different sets of claims**

Art. 105b(3) specifies that the decision to limit or revoke will apply to the patent in all Contracting States for which it has been granted. There is thus a single decision, covering all Contracting States, but this decision may include different sets of claims for different Contracting States, or determine that the limitation is in other ways different for different Contracting States. Such situations could arise in two different sets of circumstances.

*Art. 105b(3)*

### **10.1 Limitation results in the claims becoming different in different Contracting States**

The limitation could result in the claims becoming different in different Contracting States if the requester wishes to restrict the claims with respect to one or more, but not all, Contracting States in order to avoid conflict with national prior rights. Such different sets of claims

can be allowed, provided that the substantive requirements are met for all sets.

*Rule 138*

It follows from Rule 138 that a prerequisite for the introduction of different claims for different Contracting States during the limitation procedure is that the requester informs the EPO of the existence of the national prior rights when filing the different sets of claims. If he files different sets of claims without informing the EPO of the national prior rights, then the request is to be refused under Art. 105b(3) and Rule 138.

*Art. 54(3)*

For applications filed on or after 13.12.2007, different sets of claims can no longer be justified on the basis of prior art under Art. 54(3) (for transitional provisions, however, see D-VII, 8).

**10.2 Limitation is different for different Contracting States because the claims as granted were different for different Contracting States**

The limitation is different in different Contracting States because the claims forming the basis of the limitation procedure were different in different Contracting States. This situation would occur where the patent has different claims for different Contracting States, because of national prior rights or prior art under Art. 54(3) (for patents granted before 13.12.2007 or for patents granted in respect of European patent applications pending at that time), or where under Art. 61 a partial transfer of rights has taken place (Rule 18(2)).

The requester might wish to apply a limitation already introduced for one or more Contracting States to the other Contracting States, or to bring the claims into line with each other for a different reason. If this results in a single set of claims for all Contracting States, and the substantive requirements are met separately for each different set of original claims, then the request would be allowable.

Note that it would also be possible that the circumstances of this paragraph and paragraph D-X, 10.1 coexist in a single request.

**11. Multiple requests**

*Rule 90*

Rule 90 defines that the basis for the request can be the claims as amended in limitation proceedings, thus providing for multiple subsequent requests, i.e. a request for limitation or revocation following one or more earlier requests for limitation.

# **Part E**

## **Guidelines on General Procedural Matters**





# Contents

## **Introduction** **1**

## **Chapter I – Communications and notifications** **I-1**

### **1. Communications** **I-1**

1.1 General remarks I-1

1.2 Number of communications I-1

1.3 Form of decisions, communications and notices I-1

### **2. Notification** **I-2**

2.1 General remarks I-2

2.2 Method of notification I-2

2.3 Notification by post I-2

2.4 Notification to representatives I-3

2.5 Irregularities in the notification I-3

## **Chapter II – Oral proceedings** **II-1**

### **1. General** **II-1**

### **2. Oral proceedings at the request of a party** **II-1**

2.1 Request for oral proceedings by an opponent whose opposition is to be rejected as inadmissible or is deemed not to have been filed II-2

### **3. Request for further oral proceedings** **II-2**

### **4. Oral proceedings at the instance of the EPO** **II-3**

### **5. Preparation of oral proceedings** **II-3**

5.1 When can summons to oral proceedings be issued in substantive examination? II-3

### **6. Summons to oral proceedings** **II-4**

<b>7.</b>	<b>Requests for the postponement of oral proceedings</b>	<b>II-5</b>
7.1	Postponement of oral proceedings at the instigation of the Division	II-6
7.2	Postponement of oral proceedings - defined notice period	II-7
<b>8.</b>	<b>Conduct of oral proceedings</b>	<b>II-7</b>
8.1	Admission of the public to proceedings	II-7
8.2	Conduct of oral proceedings	II-7
8.2.1	Use of laptops or other electronic devices during either <i>ex parte</i> or <i>inter partes</i> oral proceedings	II-8
8.3	Opening of oral proceedings: non-appearance of a party	II-8
8.3.1	Checking the identity and authorisations of participants at oral proceedings	II-8
8.3.2	Opening the oral proceedings	II-9
8.3.3	Late arrival or non-appearance at oral proceedings	II-9
8.3.3.1	General	II-9
8.3.3.2	Procedure in opposition proceedings	II-10
8.3.3.3	Procedure in examination proceedings	II-11
8.4	Opening of the substantive part of the proceedings	II-11
8.5	Submissions by the parties	II-12
8.5.1	Use of computer-generated slideshows in oral proceedings	II-13
8.5.1.1	Opposition proceedings ( <i>inter partes</i> )	II-13
8.5.1.2	Examination proceedings ( <i>ex parte</i> )	II-14
8.6	Facts, evidence or amendments introduced at a late stage	II-14
8.7	Handwritten amendments in oral proceedings	II-16
8.8	Use of Rule 137(4) for amendments filed during oral proceedings in examination	II-18
8.9	Discussion of the facts and of the legal position	II-18
8.10	Right of the other members of the Division to put questions	II-18
8.11	Closure of oral proceedings	II-19
8.11.1	Requesting postponement during oral proceedings	II-19
<b>9.</b>	<b>Delivery of the decision</b>	<b>II-20</b>



---

<b>10.</b>	<b>Minutes of oral proceedings</b>	<b>II-21</b>
10.1	Formal requirements	II-21
10.2	Language	II-22
10.3	Subject-matter of minutes	II-22
10.4	Request for correction of minutes	II-23
<b>11.</b>	<b>Oral proceedings and interviews held by video-conference</b>	<b>II-24</b>
11.1	Requests for video-conferencing	II-24
11.1.1	Discretion regarding grant of requests for video-conferences	II-24
11.1.2	Status of oral proceedings held by video-conference	II-25
11.2	Preparations for the video-conference	II-25
11.2.1	Room reservations	II-25
11.2.2	Document camera	II-25
11.3	Submissions	II-25
11.3.1	Fax	II-25
11.3.2	E-mail	II-25
11.4	Technical problems	II-27
11.5	Checking the identity of the representative	II-27
11.6	Recording of the video-conference	II-27
<b>Chapter III – Taking and conservation of evidence</b>		<b>III-1</b>
<b>1.</b>	<b>Taking of evidence by the departments of the EPO</b>	<b>III-1</b>
1.1	General remarks	III-1
1.2	Means of evidence	III-1
1.3	Taking of evidence	III-3
1.4	Order to take evidence	III-3
1.5	Summoning of parties, witnesses and experts	III-4
1.6	Hearing of parties, witnesses and experts	III-4
1.6.1	General remarks	III-4
1.6.2	Witnesses and experts not summoned	III-5

---

1.6.3	Guidance to persons heard	III-5
1.6.4	Separate hearings	III-5
1.6.5	Examination as to personal particulars	III-5
1.6.6	Examination as to <i>res gestae</i>	III-5
1.6.7	Entitlement of parties to put questions at hearings	III-6
1.7	Minutes of taking of evidence	III-6
1.8	Commissioning of experts	III-7
1.8.1	Decision on the form of the opinion	III-7
1.8.2	Objection to an expert	III-7
1.8.3	Terms of reference of the expert	III-7
1.9	Costs arising from oral proceedings or taking of evidence	III-7
1.10	Entitlements of witnesses and experts	III-8
1.10.1	Expenses for travel and subsistence	III-8
1.10.2	Loss of earnings, fees	III-8
1.10.3	Details of the entitlements of witnesses and experts	III-8
1.11	Models	III-9
1.11.1	When may models be submitted?	III-9
1.11.2	Must the model be considered?	III-9
1.11.3	Keeping the model	III-9
1.11.4	Procedure	III-9
1.12	Video recordings	III-9
<b>2.</b>	<b>Conservation of evidence</b>	<b>III-10</b>
2.1	Requirements	III-10
2.2	Request for the conservation of evidence	III-10
2.3	Competence	III-10
2.4	Decision on the request and the taking of evidence	III-11
<b>3.</b>	<b>Taking of evidence by courts or authorities of the Contracting States</b>	<b>III-11</b>
3.1	Legal co-operation	III-11
3.2	Means of giving or taking evidence	III-11
3.2.1	Taking of evidence on oath	III-11
3.2.2	Evidence taken by a competent court	III-11
3.3	Letters rogatory	III-12
3.4	Procedures before the competent authority	III-12

3.5	Costs of taking evidence	III-12
3.6	Taking of evidence by an appointed person	III-12
<b>4.</b>	<b>Evaluation of evidence</b>	<b>III-13</b>
4.1	General remarks	III-13
4.2	Types of evidence	III-13
4.3	Examination of evidence	III-13
4.4	Asking for evidence	III-14
4.5	Evaluation of the testimony of a witness	III-14
4.6	Evaluation of the testimony of parties	III-16
4.7	Evaluation of an expert opinion	III-16
4.8	Evaluation of an inspection	III-16

#### **Chapter IV – Derogations from the language of the proceedings in oral proceedings** **IV-1**

<b>1.</b>	<b>Use of an official language</b>	<b>IV-1</b>
<b>2.</b>	<b>Language of a Contracting State or other language</b>	<b>IV-1</b>
<b>3.</b>	<b>Exceptions from sections 1 and 2</b>	<b>IV-1</b>
<b>4.</b>	<b>Language used in the taking of evidence</b>	<b>IV-2</b>
<b>5.</b>	<b>Language used by employees of the EPO</b>	<b>IV-2</b>
<b>6.</b>	<b>Language used in the minutes</b>	<b>IV-2</b>

#### **Chapter V – Examination by the EPO of its own motion; facts, evidence or grounds not submitted in due time; observations by third parties** **V-1**

<b>1.</b>	<b>Examination by the EPO of its own motion</b>	<b>V-1</b>
1.1	General remarks	V-1
1.2	Limits on the obligation to undertake examination	V-1

<b>2.</b>	<b>Late filed submissions</b>	<b>V-1</b>
2.1	General examples in opposition proceedings	V-2
2.2	Examples concerning oral proceedings in opposition procedure	V-3
<b>3.</b>	<b>Observations by third parties</b>	<b>V-5</b>

## **Chapter VI – Interruption and stay of the proceedings** **VI-1**

<b>1.</b>	<b>Interruption</b>	<b>VI-1</b>
1.1	Cases in which the proceedings may be interrupted	VI-1
1.2	Responsible department	VI-1
1.3	Date of interruption	VI-1
1.4	Resumption of proceedings	VI-2
1.5	Resumption of time limits	VI-2
<b>2.</b>	<b>Stay of proceedings under Rule 14 due to pending national entitlement proceedings</b>	<b>VI-2</b>
<b>3.</b>	<b>Stay of proceedings when a referral to the Enlarged Board of Appeal is pending</b>	<b>VI-3</b>

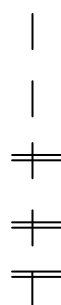

## **Chapter VII – Time limits, loss of rights, further and accelerated processing and re-establishment of rights** **VII-1**

<b>1.</b>	<b>Time limits and loss of rights resulting from failure to respond within a time limit</b>	<b>VII-1</b>
1.1	Determination of time limits	VII-1
1.2	Duration of the time limits to be determined by the EPO on the basis of EPC provisions	VII-1
1.3	Time limits which may be freely determined	VII-2
1.4	Calculation of time limits	VII-2
1.5	Effect of change in priority date	VII-2
1.6	Extension of a time limit	VII-3
1.7	Late receipt of documents	VII-4

1.8	Failure to respond within a time limit	VII-4
1.9	Loss of rights	VII-5
1.9.1	Cases of loss of rights	VII-5
1.9.2	Noting and communication of loss of rights	VII-5
1.9.3	Decision on loss of rights	VII-5
<b>2.</b>	<b>Further processing and re-establishment of rights</b>	<b>VII-5</b>
2.1	Request for further processing	VII-5
2.2	Re-establishment of rights	VII-6
2.2.1	General remarks	VII-6
2.2.2	Extension of re-establishment of rights to opponents	VII-7
2.2.3	Relevant time limits	VII-7
2.2.4	Time limits not covered	VII-7
2.2.5	Request for re-establishment of rights	VII-8
2.2.6	Special considerations when there is more than one party	VII-8
2.2.7	Decision on re-establishment of rights	VII-8
<b>3.</b>	<b>Accelerated prosecution of European patent applications</b>	<b>VII-8</b>
3.1	Accelerated search	VII-9
3.2	Accelerated examination	VII-9
<b>4.</b>	<b>Accelerated processing of oppositions</b>	<b>VII-10</b>
<b>5.</b>	<b>Accelerated processing before the Boards of Appeal</b>	<b>VII-10</b>
<b>6.</b>	<b>Renunciation of rights</b>	<b>VII-10</b>
6.1	Withdrawal of application or designation	VII-10
6.2	Withdrawal of priority claim	VII-11
6.3	Statement of withdrawal	VII-11
6.4	Surrender of patent	VII-11
<b>Chapter VIII – Applications under the Patent Cooperation Treaty (PCT)</b>		<b>VIII-1</b>
<b>1.</b>	<b>General remarks</b>	<b>VIII-1</b>

<b>2.</b>	<b>EPO as designated or elected Office</b>	<b>VIII-2</b>
2.1	General	VIII-2
2.1.1	Introduction	VIII-2
2.1.2	Initial processing and formal examination; copy of the international application; translation	VIII-3
2.1.3	Filing fee, designation fee, request for examination, search fee and claims fees	VIII-3
2.1.4	PCT vs. EPC provisions	VIII-4
2.2	Provisions of Chapter A-II ("Filing of applications and examination on filing")	VIII-5
2.3	Provisions of Chapter A-III ("Examination of formal requirements")	VIII-5
2.3.1	Representation	VIII-5
2.3.2	Physical requirements	VIII-6
2.3.3	Request for grant	VIII-6
2.3.4	Designation of inventor	VIII-6
2.3.5	Claim to priority	VIII-7
2.3.6	Title of the invention	VIII-8
2.3.7	Prohibited matter	VIII-8
2.3.8	Claims fee	VIII-8
2.3.9	Drawings	VIII-8
2.3.10	Abstract	VIII-8
2.3.11	Designation fee	VIII-8
2.4	Provisions of Chapter A-IV ("Special provisions")	VIII-9
2.4.1	Divisional applications	VIII-9
2.4.2	Sequence listings	VIII-9
2.5	Provisions of Chapter A-VI ("Publication of application; request for examination and transmission of the dossier to Examining Division")	VIII-10
2.5.1	Publication of the international application	VIII-10
2.5.2	Request for examination	VIII-10
2.5.3	Supplementary European search	VIII-11
2.6	Reduction and refunds of fees in respect of international (PCT) applications	VIII-11
2.7	Communication to the EPO as a designated Office	VIII-11
2.8	Delaying of the procedure before the EPO	VIII-11
2.9	Early processing	VIII-11
2.10	Review by the EPO as a designated Office	VIII-13
2.11	Inspection of files	VIII-13



<b>3.</b>	<b>The communication according to Rule 161</b>	<b>VIII-13</b>
3.1	Applications for which a supplementary European search report is prepared	VIII-13
3.2	Applications for which no supplementary European search report is prepared	VIII-14
3.3	Exceptions where a reply to the Rule 161(1) invitation is not required	VIII-15
3.3.1	Earlier filed amendments or comments	VIII-15
3.3.2	Positive WO-ISA, SISR or IPER	VIII-16
3.3.3	Rule 161 communication issued before 1 April 2010	VIII-16
3.3.4	Voluntary reply to Rule 161(1) communication	VIII-17
3.3.5	Indications on Form 1200	VIII-17
3.4	Rule 137(4) applies	VIII-17
<b>4.</b>	<b>Examination procedure</b>	<b>VIII-18</b>
4.1	At least one communication in examination	VIII-18
4.2	No examination of multiple inventions in EP phase	VIII-18
4.3	Substantive examination of a Euro-PCT application accompanied by an IPER	VIII-18
4.3.1	Comparative test results	VIII-19
4.3.2	Basis for substantive examination	VIII-19
4.3.3	Consideration of the contents of the IPER	VIII-20
<b>Chapter IX – Decisions</b>		<b>IX-1</b>
<b>1.</b>	<b>Basis of decisions</b>	<b>IX-1</b>
1.1	General remarks	IX-1
1.2	Examples	IX-1
<b>2.</b>	<b>Consideration of time limits</b>	<b>IX-2</b>
<b>3.</b>	<b>Authoritative text of documents</b>	<b>IX-3</b>
<b>4.</b>	<b>Written form of decisions</b>	<b>IX-3</b>
4.1	General remarks	IX-3
4.2	Order	IX-5
4.3	Facts and submissions	IX-5
4.4	Decision on the file as it stands	IX-5

---

<b>5.</b>	<b>Reasoning of decisions</b>	<b>IX-5</b>
5.1	Content	IX-7
5.2	Analysing the parties' arguments	IX-7
5.3	Main and auxiliary requests	IX-7
5.4	Late-filed submissions	IX-8
<b>6.</b>	<b>Decisions which do not terminate proceedings – interlocutory decisions</b>	<b>IX-8</b>
<b>7.</b>	<b>Binding nature of decisions on appeals</b>	<b>IX-9</b>
<b>8.</b>	<b>Information as to means of redress</b>	<b>IX-9</b>
<b>9.</b>	<b>Notification</b>	<b>IX-10</b>
<b>Chapter X – Appeals</b>		<b>X-1</b>
<b>1.</b>	<b>Suspensive effect</b>	<b>X-1</b>
<b>2.</b>	<b>Appeals after surrender or lapse of the patent</b>	<b>X-1</b>
<b>3.</b>	<b>Appeals against the apportionment of costs</b>	<b>X-1</b>
<b>4.</b>	<b>Appeals against the decision of the Opposition Division on the fixing of costs</b>	<b>X-1</b>
<b>5.</b>	<b>Persons entitled to appeal and to be parties to appeal proceedings</b>	<b>X-1</b>
<b>6.</b>	<b>Time limit and form of appeal</b>	<b>X-1</b>
<b>7.</b>	<b>Interlocutory revision</b>	<b>X-2</b>
7.1	General remarks	X-2
7.2	Remittal to the Board of Appeal	X-3
7.3	Reimbursement of appeal fees	X-3
7.4	Examples	X-4
7.4.1	No amended claims filed with the appeal	X-4
7.4.2	Amended main/single request filed with the appeal	X-4
7.4.3	Main and auxiliary requests filed with the appeal	X-6

---

<b>8.</b>	<b>Rules of Procedure for the departments of second instance</b>	<b>X-6</b>
<b>9.</b>	<b>Remittal to the Division after appeal</b>	<b>X-6</b>
9.1	Orders on remittal	X-6
9.2	Consequences for the Division	X-6

## **Chapter XI – Request from a national court for a technical opinion concerning a European patent** **XI-1**

<b>1.</b>	<b>General</b>	<b>XI-1</b>
<b>2.</b>	<b>Scope of the technical opinion</b>	<b>XI-1</b>
<b>3.</b>	<b>Composition and duties of the Examining Division</b>	<b>XI-2</b>
3.1	Composition	XI-2
3.2	Duties	XI-2
<b>4.</b>	<b>Language to be used</b>	<b>XI-2</b>
<b>5.</b>	<b>Procedure</b>	<b>XI-3</b>
5.1	Formalities check	XI-3
5.2	Preliminary examination	XI-3
5.3	Withdrawal of the request	XI-3
5.4	Establishment and issue of the technical opinion	XI-4
5.5	File inspection	XI-4
5.6	Appearance before the national court	XI-4

## **Chapter XII –Registration of changes of name, transfers, licences and other rights** **XII-1**

	<b>1.</b>	<b>General</b>	<b>XII-1</b>
	<b>2.</b>	<b>Responsible department</b>	<b>XII-1</b>
≡	<b>3.</b>	<b>Transfer of the European patent application</b>	<b>XII-1</b>
≡	<b>4.</b>	<b>Transfer of the European patent</b>	<b>XII-2</b>

---

<b>5.</b>	<b>Changes of name</b>	<b>XII-2</b>	≠
<b>6.</b>	<b>Licences and other rights</b>	<b>XII-2</b>	≠
6.1	Registration	XII-2	
6.2	Cancellation of licences	XII-2	

## **Introduction**

Part E contains guidelines for those procedural steps in respect of the examination of European patent applications and patents which without major variations may, insofar as the EPC permits, occur at a number of stages in the procedure. Attention is also drawn to Art. 125, which states: "In the absence of procedural provisions in this Convention, the EPO shall take into account the principles of procedural law generally recognised in the Contracting States".

With the exception of Chapter E-VIII, Part E does not apply to international applications which the EPO processes under the Patent Cooperation Treaty (PCT), unless stated otherwise.



## Chapter I – Communications and notifications

### 1. Communications

#### 1.1 General remarks

Communications should be sent, *inter alia*:

- (i) if a party has to be informed of deficiencies, together, where appropriate, with a request to remedy those deficiencies, e.g. in accordance with Rule 55, 58, 59, 62a, 63, 64(1), 71(1), 77(2), 95(2) or 108(2);
- (ii) if a party is to be invited to file observations on particular questions or to submit documents, evidence, etc., to clarify the issues involved;
- (iii) if, in the opinion of the Examining or Opposition Division, the patent cannot be granted or maintained in the text requested by the applicant or proprietor of the patent, but could possibly be granted or maintained in an amended text of more limited scope;
- (iv) if information necessary to the conduct of the proceedings has to be communicated to the parties, e.g. in accordance with Rule 14(2) and (3), 35(4) or 142(2) and (3);
- (v) for preparing oral proceedings, (see E-II, 5); or
- (vi) if a decision is to be based on grounds on which the parties have not yet had an opportunity to comment (see E-IX, 1).

#### 1.2 Number of communications

Since each communication issued may entail prolonging the proceedings, the proceedings should be conducted in such a way as to manage with as few communications as possible. If a communication has to be issued, it should cover all the points which are necessary, or likely to be of importance, for the particular stage of the proceedings, e.g. the preparation of oral proceedings or of a decision.

#### 1.3 Form of decisions, communications and notices

Any decision, communication or notice from the EPO is to be signed by and to state the name of the employee responsible. Where these documents are produced by the employee responsible using a computer, a seal may replace the signature. Where the documents are produced automatically by a computer the employee's name may also be dispensed with. The same applies to pre-printed notices and communications.

*Rule 113(1) and (2)*

## 2. Notification

### 2.1 General remarks

*Art. 119*  
*Rule 125*  
*Rule 126*

The EPO as a matter of course notifies those concerned of decisions and summonses, and of any notice or other communication from which a time limit is reckoned, or of which those concerned must be notified under other provisions of the EPC, or of which notification has been ordered by the President of the EPO. Notifications may, where exceptional circumstances so require, be given through the intermediary of the central industrial property offices of the Contracting States. In proceedings before the EPO, any notification to be made must take the form either of the original document, a copy thereof certified by, or bearing the seal of, the EPO, or a computer print-out bearing such seal. Copies of documents emanating from the parties themselves do not require such certification.

### 2.2 Method of notification

*Rule 125(2) and (3)*  
*Rule 127*

Notification is to be by post, by delivery on the premises of the EPO, by public notice or by such technical means of communication as determined by the President of the EPO and under the conditions laid down by him governing their use. Further details concerning notifications are given in Rules 126 to 129. Notification through the central industrial property office of a Contracting State competent to deal with the addressee must be made in accordance with the provisions applicable to that office in national proceedings.

### 2.3 Notification by post

*Rule 126*

Notification is usually made by post. Decisions incurring a period for appeal or a petition for review, summonses and other documents as decided on by the President of the EPO must be notified by registered letter with advice of delivery. All other notifications by post must be by registered letter. The President of the EPO has, so far, not named any other documents to be notified by registered letter with advice of delivery.

The letter is deemed to be delivered to the addressee on the tenth day following its posting, unless the letter has failed to reach the addressee or has reached him at a later date; in the event of any dispute, it is incumbent on the EPO to establish that the letter has reached its destination or to establish the date on which the letter was delivered to the addressee, as the case may be.

Notification is deemed to have been effected even if acceptance of the letter has been refused.

The law of the state on the territory of which the notification is made applies to other matters concerning notification, e.g. the question whether delivery to a person other than the addressee constitutes an effective notification to the latter.



**2.4 Notification to representatives**

If a representative has been appointed, notifications must be addressed to him. If several such representatives have been appointed for a single interested party, notification to any one of them is sufficient. If several persons are joint applicants for or proprietors of a patent or have acted in common in filing notice of opposition or intervention and have not appointed a common representative, notification of one person, viz. the person referred to in Rule 151, will again be sufficient. If several interested parties have a common representative, notification of a single document to the common representative is sufficient.

*Rule 130***2.5 Irregularities in the notification**

Where a document has reached the addressee, if the EPO is unable to prove that it has been duly notified, or if provisions relating to its notification have not been observed, the document is deemed to have been notified on the date established by the EPO as the date of receipt. In cases where the EPO is not able to prove the actual date of notification, a letter for instance, sent by the addressee himself which indicates the date of receipt, is accepted as proof. If it is evident from a reply from the addressee that he has received the document, although he does not mention the date of its notification, the date on which that reply was written is to be regarded as the date of notification.

*Rule 125(4)*



## Chapter II – Oral proceedings

### 1. General

By "oral proceedings" is meant formal proceedings within the meaning of Art. 116. The term therefore does not include informal personal interviews or telephone conversations, such as occur in examination proceedings and limitation/revocation proceedings (see C-VII, 2). In view of Rule 81(2), such informal personal interviews or telephone conversations are not allowed in opposition proceedings, in which more than one party is involved, unless the interview or telephone conversation concerns matters which do not affect the interests of other parties. An example is proceedings for examining the admissibility of opposition, provided this involves only the EPO and the opponent concerned.

Oral proceedings will take place before the competent body, e.g. within the Receiving Section before the competent formalities officer and during the examination and opposition procedure before the whole Division. *Art. 18(2)*  
*Art. 19(2)*

### 2. Oral proceedings at the request of a party

If, in the course of proceedings, a party requests oral proceedings, the competent department must grant this request. The EPO will not inform the party concerned of this right but will expect him – if he does not obtain satisfaction from the competent department – to request oral proceedings (if he so wishes) before a decision is reached. *Art. 116(1)*

Under Art. 116(1), parties can request oral proceedings at any time, provided a decision has not yet been issued. In particular, a request for oral proceedings made before the decision to grant or to limit has been handed over to the internal post has to be allowed (see T 556/95 and G 12/91).

Oral proceedings will take place before the Receiving Section at the request of the applicant only where the Receiving Section considers this to be expedient or where it envisages refusing the European patent application. Where the Receiving Section does not consider it necessary to hold oral proceedings, it must inform the applicant accordingly (see J 16/02). *Art. 116(2)*

The competent department will decide on the most appropriate date for the oral proceedings, which should only be held after the issues to be determined are sufficiently clear (see E-II, 5).

With a conditional request for oral proceedings, i.e. if the party concerned has indicated that the request for oral proceedings has been made solely as a precaution to cover the eventuality that the case he has put forward is not accepted, oral proceedings will be held only if a negative decision against the party concerned is envisaged.

With an unconditional request for oral proceedings, on the other hand, if the competent department considers that a decision on the matter may be reached on the basis of the written evidence obtained and intends to take a decision (e.g. in accordance with Art. 97, 101 or 105b) which fully concurs with the case put forward by the party or parties which requested the oral proceedings, the party or parties concerned should be informed accordingly and asked whether the request or requests for oral proceedings will be maintained even though the decision concurs with the case put forward. If the request is not expressly withdrawn, oral proceedings must be held.

A request to have oral proceedings held at an EPO site other than that indicated in the summons is not allowable (see T 1012/03).

### **2.1 Request for oral proceedings by an opponent whose opposition is to be rejected as inadmissible or is deemed not to have been filed**

Under Art. 116(1), oral proceedings may be requested only by a party to pending proceedings. If the Opposition Division notes deficiencies in the notice of opposition under Rule 77(1), the opponent still remains a party to the proceedings until such time as his opposition is rejected as inadmissible. This also applies when deficiencies lead to the opposition being deemed not to have been filed (see D-IV, 1.4.1).

### **3. Request for further oral proceedings**

*Art. 116(1)*

The EPO may reject a request for further oral proceedings before the same department where the parties and the subject of the proceedings are the same.

Oral proceedings, particularly in opposition proceedings, are held to give the opportunity to finally discuss all matters raised and are normally terminated with a decision announced orally. The Division is bound by that decision, once announced, and it cannot reopen the proceedings to allow further submissions to be filed or to take into account new facts (see the last two paragraphs of E-V, 2). Only if the Division, in the oral proceedings, has not announced a decision, but has decided to continue the proceedings in writing, can further submissions be examined. Such may be the case e.g. when the Examining Division indicates that it intends to grant a patent (or to limit a granted patent in limitation proceedings) on the basis of the documents filed during the oral proceedings.

Thus, as a rule, in examination, limitation or opposition proceedings there will be no justification for further oral proceedings, for example where one of the parties wishes to re-examine from a different viewpoint a subject already discussed in the course of the proceedings, either before or during the original oral proceedings. However, if the oral proceedings are not terminated with a decision and after the oral proceedings the subject of the proceedings changes, for example where fresh evidence is admitted into the proceedings after the original oral proceedings, then further oral

proceedings will generally have to be held if requested (see T 194/96).

#### **4. Oral proceedings at the instance of the EPO**

The competent department of the EPO may arrange for oral proceedings to take place without a request from a party if it considers this to be expedient.

*Art. 116(1)*

Oral proceedings will normally only be expedient if after an attempt at written clarification there are still questions or doubts which have a crucial bearing on the decision to be reached and which may be more efficiently or surely settled by oral discussion with the party or parties or if it is necessary to take evidence as part of oral proceedings (see E-III, 1.3 and 1.6.1). The competent department should also bear in mind the need for economy in such procedures, since oral proceedings give rise to costs for both the EPO and the party or parties.

#### **5. Preparation of oral proceedings**

The purpose of oral proceedings should be to settle as far as possible all outstanding questions relevant to the decision. To this end proceedings should be carefully prepared after examination of all the written matter submitted and with this in mind the most appropriate date for conducting oral proceedings chosen.

When preparing oral proceedings in opposition proceedings, the Opposition Division should consider carefully whether complex legal issues are likely to arise, and it may therefore decide to enlarge the Division by adding a legally qualified member (Art. 19(2)).

Insofar as certain questions relevant to the decision are considered by the EPO to require discussion, it will in many cases be expedient to inform the party or parties in a notice and possibly also to invite one or more of the parties to submit written observations or to produce evidence, where appropriate. Parties may produce evidence in support of their arguments on their own initiative. Where, however, the evidence is such as should have been put forward at an earlier stage, e.g. in opposition proceedings pursuant to D-IV, 1.2.2.1(v) and 5.4, it is for the competent body to consider whether the evidence not filed in due time is to be admitted (see E-V, 2). Any observations should be received in time for them to be communicated to the other parties at the latest one month before the oral proceedings. The time limit for submission of observations should be fixed accordingly, particularly where the invitation to file observations is issued at the same time as the summons to oral proceedings.

##### **5.1 When can summons to oral proceedings be issued in substantive examination?**

At the beginning of substantive examination, if the Examining Division is of the opinion that the application cannot be granted directly, at least one substantive communication within the meaning of Art. 94(3)

must be sent before the Division can consider issuing a summons to oral proceedings (see C-III, 4).

In particular it should be noted that neither the search opinion of an EESR or a supplementary search (ESOP) nor an opinion or report from the PCT procedure (WO-ISA, SISR, IPRP or IPER) is a communication under Art. 94(3), so that even if the applicant has replied thereto, it is not possible to send a summons as a first communication in European substantive examination.

Nor are the following communications/requests considered as substantive communications from the Examining Division for this purpose: invitation under Rule 62a or Rule 63, communication under Rule 137(4), request under Rule 53(3), request under Art. 124 and Rule 141, invitation under Rule 164(2)(a).

In examination proceedings, where the applicant has been invited to provide a translation of the priority according to Rule 53(3) (see A-III, 6.8.2, and F-VI, 3.4), no summons to oral proceedings will be issued until either the translation is provided or the period for further processing in respect of the time limit according to Rule 53(3) has expired.

#### **6. Summons to oral proceedings**

*Rule 115(1)*  
*Art. 119*

All parties must be duly summoned to oral proceedings by notification. The summons must state the subject and the date and time of the oral proceedings.

The Division should set a single date for the oral proceedings, i.e. one day or, in particular cases, more than one consecutive days. No pre-announcement of the date by phone or fax will be made.

*Rule 116(1)*

The summons will be accompanied by a note drawing attention to the points which need to be discussed, normally containing the provisional and non-binding opinion of the Division. The summons will also fix a date up to which written submissions may be filed or amendments which meet the requirements of the EPC may be submitted (see also D-VI, 3.2).

*Rule 115(1)*

Rule 115(1) stipulates that at least two months' notice of the summons must be given unless the parties agree to a shorter period.

Harmonised with the standards applied in the written procedure (E-VII, 1.2), the practice outlined below should be followed in setting the date of the oral proceedings to allow the parties sufficient time for preparing and filing submissions:

- (i) Any time limit (even shorter than two months) may be set provided that prior agreement has been reached with the parties.

- (ii) Normally, the summons should be issued at least four months ahead of the day of the oral proceedings.
- (iii) Between two and four months' notice can be given without preliminary agreement only in specific circumstances, since the parties would have very limited time for filing submissions before the date fixed in the summons. Examples are where, in examination, the summons follows an extensive exchange between the first examiner and the applicant, or where the oral proceedings must be postponed (see also E-II, 7.2).
- (iv) A longer time limit may be set where appropriate, e.g. where it is clear that in the circumstances of the specific case a time limit of four to five months cannot be adhered to or where the division is facing problems finding a suitable room.

The summons must state that if a party duly summoned does not appear as summoned, the proceedings may continue without him.

In opposition proceedings as a rule, even oral proceedings requested on the basis of totally different grounds for opposition should be conducted as a single set of proceedings.

In cases of multiple oppositions, all oral proceedings requested should be dealt with in a single session, even if the oppositions are based on different grounds. This means that all the parties must be summoned to attend them and may present comments on all grounds raised.

### **7. Requests for the postponement of oral proceedings**

A request for the postponement of oral proceedings is allowable only if the party concerned can advance serious reasons which justify the fixing of a new date (see T 1080/99, T 300/04, J 4/03 and T 178/03). The request to fix another date must be filed as soon as possible after the grounds preventing the party concerned from attending the oral proceedings have arisen. It must be accompanied by a sufficiently substantiated written statement indicating these reasons (see OJ EPO 2009, 68; see also T 178/03).

Serious reasons to request a change of the date for oral proceedings may be, for instance:

- a previously notified summons to oral proceedings of the same party in other proceedings before the EPO or a national court
  - for the same date or
  - for the preceding or following day or

- for the two preceding or two following days where the other oral proceedings are to take place at a geographically distant location,
- serious illness,
- a death within the family,
- the marriage of a person whose attendance in oral proceedings is relevant,
- military service or other obligatory performance of civic duties,
- business trips which have been firmly booked before notification of the summons to oral proceedings,
- holidays which have already been firmly booked before notification of the summons to oral proceedings. In the case of holidays scheduled but not yet booked, the representative should indicate the circumstances (e.g. school holidays) which prevent the holidays from being rescheduled.

If the grounds for postponing the oral proceedings submitted by a party do not meet the above criteria, the Division will inform the parties that the oral proceedings will take place as set out in the summons.

It should be noted that in opposition proceedings, in particular if more than one opponent is involved, a more strict approach may be applied to prevent a series of postponements (see T 1102/03).

Grounds which, as a rule, are not acceptable are, for instance:

- a summons to oral proceedings before the EPO or a national court notified after the summons in the relevant proceedings,
- excessive work pressure.

In order to make effective use of the available meeting rooms, and as Mondays and Fridays are normal working days, oral proceedings will be scheduled for these days. The fact that the representative and/or the parties have to travel at weekends is not a sufficient reason to change the date of the oral proceedings. The departments of first instance will however, circumstances permitting, try to be flexible where there is a request to postpone the starting time in order to enable the party to travel on the same day.

### **7.1 Postponement of oral proceedings at the instigation of the Division**

In exceptional cases the Division might have to instigate postponement of oral proceedings for reasons similar to those



mentioned above. The proceedings should, however, be postponed only if a suitable replacement cannot be found.

## **7.2 Postponement of oral proceedings - defined notice period**

The notice period defined in Rule 115(1), i.e. at least two months, is valid also in case of a postponement, unless the parties have agreed on a shorter period (see also E-II, 6(iii), and E-II, 8.11.1).

## **8. Conduct of oral proceedings**

### **8.1 Admission of the public to proceedings**

Oral proceedings before the Receiving Section, the Examining Divisions and the Legal Division are not public. *Art. 116(3)*

Oral proceedings, including delivery of the decision (see E-II, 9), are public before the Opposition Divisions insofar as the Opposition Division does not decide otherwise in cases where admission of the public could have serious and unjustified disadvantages, in particular for a party to the proceedings. This could, for example, be the case if one of the parties wishes to give information about sales figures or other commercial secrets in support of his case. Generally, the public will only be excluded whilst such information is being given. *Art. 116(4)*

### **8.2 Conduct of oral proceedings**

Before the Receiving Section oral proceedings will be conducted by the formalities officer and before the Examining or Opposition Divisions by the Chairman of the Division concerned.

The responsibilities of the person conducting the proceedings will include keeping order and conducting the proceedings as regards their formal and substantive aspects.

The person conducting the proceedings must in particular ensure that, where necessary, a list is prepared of all disputed or unclear points relevant to the decision to be reached, that these are discussed and that the party or parties have the opportunity of commenting on them.

On the other hand, the oral proceedings are to be conducted strictly and efficiently, so that the submissions of the party or parties and the discussions are not unnecessarily digressive and do not deal with points which are of no relevance to the decision to be reached. Repetition should be avoided as far as possible. In particular, written material submitted at the appropriate time to the competent department and to the party or parties which has already been the subject of proceedings need not be read out *in extenso*. A simple reference to such written material may suffice.

### **8.2.1 Use of laptops or other electronic devices during either *ex parte* or *inter partes* oral proceedings**

As a general rule, the use of laptops or other electronic devices during oral proceedings is allowed provided they do not cause disturbance to the participants and are not used for sound recording (see the Notice of the Vice-Presidents Directorates General 2 and 3 dated 25 February 1986 and issued in OJ EPO 1986, 63).

Only in exceptional circumstances, where, for example, the use of an electronic device disturbs the oral proceedings and despite warning of the Division the disturbance is not remedied, can the Division decide not to admit the use of the incriminated device. It should be taken into consideration that it is normal for a representative to rely on electronically stored documents to present his case and he may be put in a difficult position if the Division denies him the right to use his laptop.

## **8.3 Opening of oral proceedings: non-appearance of a party**

### **8.3.1 Checking the identity and authorisations of participants at oral proceedings**

Professional representatives need to file authorisations only in exceptional cases (see Decision of the President of the EPO, Special edition No. 3, OJ EPO 2007, L.1).

Authorisations need be checked only if a party is represented by a person whose authorisation is not apparent from the file. If it is established that the person is either

- (a) a professional representative acting under a sub-authorisation
- (b) a professional representative from the same agency as the representative acting in the case, or
- (c) a natural person (e.g. executive director) authorised by law in the party's country of business to act on behalf of that party

then no further check is required.

If however the person is:

- (a) a professional representative who is neither from the same agency nor acting under a sub-authorisation, and his/her attendance at the oral proceedings is his/her first appearance in the procedure, or
- (b) a legal practitioner or a party's employee who is not an authorised professional representative

then the procedure is as follows:

In case (a), the Division will check the file to see whether the previous representative's authorisation has lapsed. A change in representative or the termination of the authorisation of a previous representative may have been effected via an electronic notification through the MyFiles service (see OJ EPO 2012, 352). If the previous representative's authorisation has lapsed, no further action is required. If not, the representative concerned will be requested to provide a reference to a registered general authorisation or to file an individual authorisation.

In case (b), the Division will request the person concerned to provide a reference to a registered general authorisation or to file an individual authorisation.

A person without an authorisation will be requested to submit one without delay. If he is unable to do so straight away, a time limit of two months will be set for its submission. The fact that the authorisation was missing, and the time limit set for submitting it, must be recorded in the minutes. The proceedings then continue in the normal way, except that no decision can be pronounced at the end. Instead, the decision is issued in writing once the missing authorisation has been filed. At the end of the proceedings, the party concerned should be reminded to file the authorisation.

The person conducting the proceedings will have the particulars of the persons taking part taken and their authorisations checked, where necessary, before the start of the oral proceedings. Parties and their representatives must identify themselves unless they are known to the person conducting the proceedings or any of the members of the Examining or Opposition Division.

### **8.3.2 Opening the oral proceedings**

After opening the oral proceedings the person conducting them will introduce the parties present. He will have the particulars of the persons taking part in the proceedings recorded and will establish in what capacity they are present. Details of these steps and any consequences thereof will be recorded in the minutes (see E-II, 10).

### **8.3.3 Late arrival or non-appearance at oral proceedings**

#### **8.3.3.1 General**

If an absent party was not duly summoned, this is noted in the minutes and the oral proceedings are closed. A new date must be fixed for further oral proceedings.

If a party who has been duly summoned to oral proceedings does not appear as summoned, the oral proceedings may be conducted without him, since a party should not be able to delay issuance of a decision by failing to appear. This applies also in case of an explicit

*Rule 115(2)*

withdrawal of the request for oral proceedings or if a party has indicated that he will not attend (which is normally interpreted as equivalent to a withdrawal (see T 3/90, T 696/02 and T 1027/03)).

If the Division decides that oral proceedings are nevertheless to be conducted, this means that there are objections still outstanding that need to be discussed at the oral proceedings. Consequently the applicant and/or patentee can expect that problems relating to the requests filed in reply to the summons to oral proceedings will be dealt with at the oral proceedings.

If the applicant and/or patentee decides not to attend the oral proceedings, he is thereby choosing not to make use of the opportunity to comment at the oral proceedings on any of the objections, but to rely on the arguments as set out in the written submissions. The decision may be given orally in his absence. The procedural principles require that the party to the proceedings is not taken by surprise by the decision.

It is to be noted that if a party appears **before the end** of the oral proceedings, he has the right to be heard.

If the party appears only **after the proceedings** have been closed, the Division may reopen them at its discretion, subject to two conditions:

- (a) the Division has not pronounced a decision under Art. 97(1) or (2) or Art. 101(2) or an interlocutory decision under Art. 106(2) maintaining the patent in amended form according to Art. 101(3) (see also D-VI, 7.2.2) or a decision to reject the request for limitation under Rule 95(4).
- (b) all parties to the proceedings agree to the reopening.

*Art. 104(1)*

If, however, an allowable request for the postponement of oral proceedings has been filed (see E-II, 7), the proceedings should be postponed and a new date fixed. If the filing of the request was delayed due to the carelessness of the party concerned, the proceedings may, depending on the circumstances, still be postponed; if this happens in opposition proceedings, a decision on the apportionment of costs may have to be taken (see D-IX, 1.4).

### **8.3.3.2 Procedure in opposition proceedings**

If new facts or evidence are submitted during *inter partes* oral proceedings which a party, although duly summoned, fails to attend, it must first be examined whether these submissions may be disregarded (Art. 114(2); see also E-II, 8.6 and E-V, 2).

Following G 4/92, if new facts are taken into consideration, then at the end of the oral proceedings a decision based on these facts cannot be taken against the absent party. Further, new evidence can only be

used against the absent party if it has been previously notified and merely supports the previous assertions of the party who submits it. However, new arguments may be used at any time, insofar as they do not change the grounds on which the decision is based.

In other words, what the Enlarged Board of Appeal ruled out in G 4/92 was the possibility of taking decisions against the absent party on the basis of a surprising course of events at the oral proceedings, which changes the legal and factual framework of the case in an unforeseeable way (see T 414/94).

An absent party cannot be considered taken by surprise if during oral proceedings the other side attempts to overcome objections raised before the oral proceedings. In particular, a submission during oral proceedings of a more restricted and/or formally amended set of claims with a view to overcoming the objections of the opponent is not considered a "new fact" (see T 133/92 and T 202/92). Nor is it unexpected that amended claims are examined for formal admissibility and for compliance with Art. 123(2) and (3) (see T 341/92).

In the particular case of an absent opponent, if new prior art is submitted for the first time during oral proceedings which may be an obstacle to the maintenance of the opposed patent, this new prior art can be taken into consideration despite the opponent's absence because it is in the opponent's favour (see T 1049/93).

#### **8.3.3.3 Procedure in examination proceedings**

Oral proceedings give the applicant an opportunity to exercise his rights under Art. 113(1). In examination proceedings, when an applicant files amended claims before oral proceedings which he subsequently does not attend, he may expect a decision based on objections which might arise against such claims in his absence. A decision can be taken based on facts and arguments presented earlier in the proceedings and/or based on new arguments which may be expected to be raised (see OJ EPO 2008, 471).

In examination proceedings, the summons to oral proceedings should include all the objections that are likely to be discussed during oral proceedings and should indicate that amended claims in response to the communication will have to be examined at the oral proceedings for compliance with the EPC. This ensures that the applicant's right to be heard (Art. 113(1)) is respected and that the proceedings are not delayed unnecessarily if an applicant does not attend oral proceedings.

#### **8.4 Opening of the substantive part of the proceedings**

Insofar as necessary, the person conducting the proceedings will outline the stage reached in the proceedings and will indicate the most important matters in dispute according to the file. In examination

or opposition proceedings this may also be done by the primary examiner.

### **8.5 Submissions by the parties**

After the introduction referred to above, the party or parties will be allowed the floor in order to put their cases and to make applications on procedural matters and state the grounds thereof. In the normal course of events each party should have only one opportunity of making a comprehensive statement.

In opposition proceedings the opponents will generally speak first and the patent proprietor afterwards. Where there are a number of opponents, it may be expedient to grant the patent proprietor an opportunity of replying directly after the statement of each individual opponent. The opponents and the patent proprietor should be given the opportunity of making a final reply.

The submissions of the party or parties may be prepared in writing, although they should as far as possible be made extemporaneously. Passages from documents already introduced into the proceedings which are referred to again should only be read out where their precise wording is relevant.

Submissions by a person who is not qualified under Art. 133 and 134 to represent parties to proceedings before the EPO may be admitted at oral proceedings when this person accompanies a professional representative representing that party. Such submissions, however, cannot be made as a matter of right, but only with the permission and at the discretion of the Examining or Opposition Division. In opposition proceedings the Division should consider in exercising its discretion whether (see G 4/95):

- (i) the party on behalf of which the person is to speak has filed a request to this effect;
- (ii) the party making the request has indicated the name of the person, the subject-matter of the submission and the person's qualification to speak on this matter;
- (iii) the request has been filed sufficiently in advance of the oral proceedings;
- (iv) in the case of a late-filed request, either there are exceptional circumstances justifying the admission of the submission or all the other parties agree to the making of the submission; and
- (v) the submissions are made under the continuing responsibility and control of the professional representative.

If neither of the alternative conditions mentioned under (iv) are met, a late-filed request should be refused. The time limit to be applied when

deciding whether a request was late-filed is that fixed in the summons under Rule 116.

If a party is represented by an authorised employee rather than a professional representative, the same considerations apply in respect of a person accompanying the authorised employee. As no other party is affected, Examining Divisions can adopt a more liberal approach than Opposition Divisions.

Parties are not to be considered as accompanying persons in the sense of G 4/95 (see T 621/98). They have the right to make submissions in oral proceedings by virtue of their status as party to the proceedings.

≡ If written submissions are made during oral proceedings, the Division should make sure that requirements such as typed-form, signature and dating of the submissions are met (T 733/99). See also E-II, 8.7.

### **8.5.1 Use of computer-generated slideshows in oral proceedings**

In oral proceedings a computer-generated slideshow cannot be used as a matter of right, but only with the permission of and at the discretion of the Examining or Opposition Division (T 1556/06).

Care should be taken that presentations of computer-generated slideshows do not negatively impact the efficient conduct of oral proceedings (e.g. interruptions for the technical preparations for the presentation). Similar considerations apply to the use of other visual aids (e.g. flipcharts, pictures).

⊕ Furthermore, with computer-generated slideshows it must be borne in mind that requests to provide equipment such as projectors for the presentation of a computer-generated slideshow must be refused. Screens, however, should be available in most meeting rooms.

#### **8.5.1.1 Opposition proceedings (inter partes)**

As a prerequisite, copies of the material to be presented must be provided in good time before the oral proceedings, i.e. Rule 116 applies. These copies are treated like any other submission made in writing.

The Opposition Division should decide whether the presentation of a computer-generated slideshow would facilitate the proceedings, after having heard the parties and taking into account whether allowing or refusing the use of the presentation would be detrimental to any participant.

A balance should be found between the presenter's interest in defending his case in the most appropriate manner, and the opposing party's need to fully understand the submissions made and to have a true opportunity to respond.

The presentation of computer-generated slideshows in oral proceedings should be allowed if in the absence of this visual aid it would be much more difficult to follow the party's submissions. For example, slides showing:

- (a) the structure or functioning of a product which is complex, or
- (b) complicated reaction schemes,
- (c) complex formulae, or
- (d) the operation of a complex apparatus

might be considered by the Opposition Division to facilitate the discussion.

If copies of the material to be presented have not been filed in good time, or if the slides contain new matter, the presentation may be disregarded under Art. 114(2) and Rule 116. In this case the Opposition Division will apply the same criteria for admissibility as are used for other late-filed facts or evidence (see E-II, 8.6).

#### **8.5.1.2 Examination proceedings (ex parte)**

As no other party is affected, Examining Divisions may adopt a more liberal approach than Opposition Divisions. Therefore, Examining Divisions should consider allowing the presentation of a computer-generated slideshow even if the slides are not communicated in advance of the oral proceedings, provided that:

- (a) the Examining Division feels able to deal with this late-filed material without unduly lengthening the proceedings. The same considerations as for other late-filed facts and evidence apply (see E II, 8.6);
- (b) the room in which oral proceedings are held provides adequate basic facilities (e.g. a screen);
- (c) the submissions contribute to the resolution of the questions at issue.

#### **8.6 Facts, evidence or amendments introduced at a late stage**

With respect to facts and evidence not submitted in due time or arguments presented at a late stage in the proceedings in general, see E-V, 2. Concerning facts and evidence not filed within the opposition period, see D-IV, 1.2.2.1(v).

#### *Rule 116(1)*

Rule 116(1), being an implementation of Art. 114(2) as a further development on the existing jurisprudence regarding facts or evidence not filed in due time, makes it clear that the Examining or Opposition Division has a discretion to disregard new facts or evidence for the reason that they have not been filed before the date



indicated in the summons under Rule 116, unless they have to be admitted because the subject of the proceedings has changed.

⊢ Examples of such changes would be:

- ⊢ – In timely response to the points raised in the note annexed to the summons, the proprietor files amendments which have the result that a new document becomes relevant; in such a case the opponent should be allowed to present this document and must be given a chance to comment on the amendments (Art. 113(1)). For the purpose of admissibility, a document's relevance should normally be decided relative to the amended claims against which it is cited. Documents that have limited relevance to an initial set of claims may acquire new relevance as a result of subsequent amendments to those claims (T 366/11).
- ⊢ – A new ground of opposition is introduced during oral proceedings: the opponent should always be granted the right to be heard, even where the arguments concern a late-filed ground of opposition and new arguments and evidence related to it (T 117/02).

Rule 116(2) imposes the same obligations on the applicant or patent proprietor when submitting new documents which meet the requirements of the EPC (i.e. new amendments to the description, claims and drawings) as Rule 116(1) imposes on the parties in submitting new facts and evidence. Here the Division also has the discretion to disregard amendments because they are filed too late before the oral proceedings. However, where the opponent files, before the indicated date, pertinent new material, the patent proprietor must be given a chance to present his comments and submit amendments (Art. 113(1)).

*Rule 116(2)*

Analogously, the proprietor should always be given the opportunity to submit amendments intended to overcome objections raised by the Division which depart from a previously notified opinion (T 273/04).

In exercising this discretion, the Division will in the first place have to consider the relevance of the late-filed facts or evidence (see E-V, 2) or the allowability of the late-filed amendments, on a ***prima facie*** basis. If these facts or evidence are not relevant or if these amendments are clearly not allowable, they will not be admitted. Before admitting these submissions, the Division will next consider **procedural expediency**, the **possibility of abuse of the procedure** (e.g. one of the parties is obviously protracting the proceedings) and the question whether the parties **can reasonably be expected** to familiarise themselves in the time available with the new facts or evidence or the proposed amendments.

*Rule 116(1) and (2)*

As regards **procedural expediency**: where the late-filed facts or evidence are relevant, but their introduction would cause a prolonged adjournment of the proceedings, the Division may decide to not admit these facts or evidence in the proceedings. An example would be where the witness lives abroad and still has to be found or lengthy tests are still necessary. The Division may, however, also postpone the proceedings and in doing so may have to consider the apportionment of costs in opposition proceedings (Art. 104).

Examples of possible **abuse of the proceedings** would be:

- The patent proprietor introduces at short notice a proliferation of auxiliary requests which are not a reaction to the course of the proceedings.
- The opponent files an assertion of public prior use, based on activities of the opponent himself, late in the absence of good reasons for the delay (see T 534/89).
- The applicant or patent proprietor presents a large number of requests, or incomplete variants of requests, and invites the Division to choose, shifting the responsibility for determining the content of the application or patent to the Division. It is the duty of any party to proceedings to make its own case and to formulate its own requests (see T 446/00).

In opposition proceedings the parties should be heard on such matters. If the Opposition Division approves the introduction of new facts or evidence and if the other parties have not had sufficient time to study them, it should, where easily comprehensible subject-matter is involved, grant the parties an opportunity of familiarising themselves with it, possibly by briefly interrupting the oral proceedings. If this is not feasible, the other parties must, upon request, be given the opportunity to comment in the proceedings subsequent to the oral proceedings, where appropriate in a further set of oral proceedings. Where possible, however, oral proceedings should not be adjourned. Where possible, legal commentaries, decisions (of a Board of Appeal, for example) and reports on legal decisions which are to be referred to in oral proceedings should be notified to the Opposition Division and the other parties in good time before the proceedings. They may, however, be quoted or submitted for the first time in the oral proceedings themselves if the Opposition Division agrees after consulting the parties.

As regards the costs which may be incurred for late submissions, see D-IX, 1.4.

### 8.7 Handwritten amendments in oral proceedings

The requirement of Rule 49(8), that the description, claims and abstract, as well as the request for grant, must be typed or printed extends to documents replacing application documents and to

amended patent specification documents (Rules 50(1) and 86). This applies to documents submitted during oral proceedings as well.

Responsibility for formally correct submissions and, in particular, for compliance with Rule 49(8) lies with the applicant/proprietor. In order to assist the parties in such circumstances, the Office provides technical facilities that allow for compliance with the formal requirements, in particular computers equipped with a word processor and a printer, network printers and copiers enabling documents to be printed from a USB stick, and internet access in public areas via a public wireless network.

Whereas the formal requirements of Rule 49 apply to documents submitted during oral proceedings as well, documents containing handwritten amendments will normally be accepted by the division as a basis for discussion during oral proceedings until agreement is reached on the final text of the patent. A final decision granting a patent or maintaining it in amended form may be taken only on the basis of a document which is not formally deficient.

If the applicant or the patent proprietor is unable to provide formally correct amendments during oral proceedings, the following applies:

- (a) If a decision to refuse a patent application or revoke a patent is imminent and handwritten documents making up the application or the patent are on file, to avoid prolonging the proceedings the Examining or Opposition Division should go ahead and issue the decision, based on substantive arguments. It may however mention this formal deficiency in the decision.
- (b) If, in examination proceedings, there is agreed patentable subject-matter, the Examining Division should invite the applicant to file the submissions in typed or printed form within two months. Should the applicant fail to do so, the application is deemed to be withdrawn. If the amendments submitted differ from what was agreed in the oral proceedings, the procedure described in C-V, 4.7 applies.
- (c) If, in opposition proceedings, the patent can be maintained in amended form, the parties should be informed that the proceedings will be continued in writing. The Opposition Division will then invite the patent proprietor to file compliant documents within two months. Opponents have to be given sufficient time to analyse, comment on and/or object to these documents. If the requested documents are not filed in due time, and there is no pending request for oral proceedings, the patent is revoked pursuant to Art. 101(3)(b).

### **8.8 Use of Rule 137(4) for amendments filed during oral proceedings in examination**

A communication under Rule 137(4) should not be sent in respect of amendments filed during oral proceedings (see H-III, 2.1.3), since this would unduly delay the procedure. Making a request under Rule 137(4) during oral proceedings would have the consequence of staying the proceedings for one month, while waiting for the applicant's answer.

The Examining Division should therefore request the applicants to provide a basis for any amendments submitted during oral proceedings before any new amendments can be admitted into the proceedings.

In special cases, e.g. where there are many auxiliary requests which are difficult to check for compliance with the requirements of Art. 123(2) and the requests do not comply with Rule 137(4), the Examining Division may exercise its discretion by not admitting these requests under Rule 137(3) rather than raising an objection under Rule 137(4) (see H-II, 2.3 and H-III, 3.3.1.1).

### **8.9 Discussion of the facts and of the legal position**

A discussion will be conducted with the party or parties concerning those technical or legal questions which are relevant to the decision and which, after the parties have made their submissions, do not appear to have been sufficiently clarified or discussed or are seemingly contradictory. Where necessary, it should be ensured that the party or parties file requests which are to the point and that the applicant or proprietor formulates the claims appropriately.

If the Examining Division finds that some patentable subject-matter results from a limitation or an amendment of the claims, it should inform the applicant of the fact and allow him an opportunity to submit amended claims based thereon.

If the competent department intends to depart from a previous legal assessment of the situation with which the parties are acquainted or from a prevailing legal opinion, or if facts or evidence already introduced into the proceedings are seen in a different light – e.g. during the deliberations of the Examining or Opposition Division (see E-II, 8.11) – so that the case takes a significant turn, the parties should be informed thereof.

### **8.10 Right of the other members of the Division to put questions**

The Chairman must allow any member of the Examining or Opposition Division who so requests to put questions. He may determine at which point in the proceedings such questions may be put.

In oral proceedings, questions may be put to the parties in connection with their statements or the discussion of the facts or of the legal position. When evidence is taken as part of oral proceedings questions may also be put to the witnesses, parties and experts called. As regards the right of the parties to put questions, see E-III, 1.6.7.

### **8.11 Closure of oral proceedings**

If the competent department considers that the matter has been sufficiently thoroughly discussed, it must decide on the subsequent procedure to be followed. Where the department consists of a number of members – as in the case of the Examining and Opposition Divisions – they must, if necessary, deliberate on the matter in the absence of the parties. If new aspects emerge during the discussion and require further questions to be put to the parties, the proceedings may be restarted. The person conducting the proceedings may thereafter give the decision of the department. Otherwise he should inform the party or parties of the subsequent procedure and then close the oral proceedings.

While the department is bound by the decision it issues on substantive matters (see E-II, 9), it is free, as a result of further reflection, to inform the parties that it intends to depart from the procedure which it has announced.

The subsequent procedure may, for example, consist in the department issuing a further communication, imposing certain requirements on one of the parties, or informing the parties that it intends to grant or maintain the patent in an amended form. As regards the delivery of a decision in the last case, see E-II, 9.

If the patent is to be granted or maintained in an amended form, it should be the aim to reach an agreement upon the final text in the oral proceedings. If, however, by way of exception the Examining or Opposition Division indicates during the oral proceedings that it would be willing to grant or maintain a European patent provided that certain amendments are made which could not reasonably have been foreseen from the earlier procedure, the applicant or patent proprietor will be given a time limit of normally 2 to 4 months in which to submit such amendments. If the applicant or patent proprietor fails to do so, the application will be refused or the patent will be revoked.

#### **8.11.1 Requesting postponement during oral proceedings**

Oral proceedings in examination, limitation or opposition are intended to bring the proceedings to a close, and parties are expected to prepare themselves fully.

The Division should therefore normally refuse any request from a party that the proceedings be postponed or continued in writing.

Even if the description needs to be revised to bring it into conformity with amended claims, the applicant or proprietor should be expected to make the necessary changes either in the oral proceedings or during a break.

Continuing oral proceedings on a day other than the one set out in the summons requires a new summons according to Rule 115(1) to be issued unless all parties can agree to a shorter period of notice.

### **9. Delivery of the decision**

*Rule 111(1) and (2)*

The delivery of the decision will follow a statement by the person conducting the proceedings announcing the operative part of the decision (see also E-II, 8.11 and E-IX, 4).

The operative part may, for example, read as follows:

"The patent application ... is refused." or

"The opposition to the patent ... is rejected." or

"The patent ... is revoked." or

"Taking account of the amendments made by the proprietor in the opposition proceedings, the patent and the invention to which it relates satisfy the requirements of the Convention." or

"The request for limitation of the patent .... is allowable." or

"The request for limitation of the patent .... is rejected."

Once a decision has been pronounced, submissions of the party or parties cannot be considered any longer and the decision stands, subject to the correction of errors in accordance with Rule 140. It may only be amended by appeal (see E-X, 1, 7 and 8).

No pronouncement need be made at this point as to the reasons for the decision or the possibility of appeal. However, the Examining or Opposition Division may give a short explanation of the reasons for the decision.

Subsequently the decision in writing (see E-IX) containing the reasoning and information as to right of appeal must be notified to the parties without undue delay. The period for appeal will only begin to run from the date of notification of the written decision.

Generally speaking it will not be possible to give a decision granting a European patent or maintaining it in amended or limited form in oral proceedings since, in the case of the grant of a patent, the requirements laid down in Rule 71(3) to (7), and in the case of a patent being maintained in amended or limited form, the requirements of Rule 82(1) and (2) or Rule 95(3) must be fulfilled.

The division should further ensure that the result of oral proceedings in opposition is made available to the public online immediately after the hearing. If the patent is maintained on the basis of amendments filed during oral proceedings, these amendments should be made public as well.

## **10. Minutes of oral proceedings**

(As regards the minutes of taking of evidence, see E-III, 1.7)

### **10.1 Formal requirements**

Minutes of oral proceedings must be drawn up.

*Rule 124(1)*

The person conducting the proceedings must ensure that during the whole proceedings an employee is available to keep minutes. If necessary, during oral proceedings different employees may carry out the task of minute-writing in sequence. In this case it must be made clear in the minutes which section was drawn up by which employee. The employees are normally members of the competent department, e.g. the Examining or Opposition Division. The minutes are normally taken down by hand by the member of the Division charged with this task. Following the proceedings, the handwritten minutes are typed out.

The minutes must be signed by the employee responsible for drawing them up and by the employee who conducted the oral proceedings. They are not signed by the parties. The parties must be provided with a copy of the minutes. Copies must be notified to them as soon as possible after the oral proceedings.

*Rule 124(3) and (4)*

Provided the parties have been informed, oral proceedings may be recorded on sound recording apparatus. However, no person other than an EPO employee is allowed to introduce any such apparatus into the hearing room (see Notice of the Vice-Presidents of the Directorates-General 2 and 3 dated 25 February 1986 concerning sound recording devices in oral proceedings before the EPO, OJ EPO 1986, 63).

Sound-recordings should be made only in specific exceptional circumstances, for example if the Division expects

- (a) witness testimony
- (b) complex proceedings (e.g. because of the subject-matter or number of parties)
- (c) requests for amendments to the minutes because of the importance of the case.

The recording should be kept until the end of any possible proceedings. Copies of the recording will not be provided to the parties.

The minutes must first include the date of the proceedings, the names of the members of the department, e.g. the Opposition Division, present and the name or names of the minute-writer or writers. Minutes must also include the details referred to in E-II, 10.3.

### **10.2 Language**

The minutes are normally written in the language of the proceedings under Art. 14(3), i.e. the EPO official language in which the application was filed or into which it was translated. The exceptions are set out in Rule 4(6).

Amendments to the text of the description or claims of the application or patent must be recorded in the minutes in the language of the proceedings under Art. 14(3).

Where the exact wording is important, or if the parties so insist, the minutes must record the following, word for word, in the EPO official language actually used by the party or into which his statements were translated, as provided for in Rule 4(6):

- (a) requests of the parties
- (b) legally relevant statements by parties, witnesses, experts and division members, and
- (c) tenor of the decision.

For derogations from the language of proceedings see E-IV, 6.

### **10.3 Subject-matter of minutes**

*Rule 124(1)*

Minutes must contain the essentials of the oral proceedings and the relevant statements made by the parties, together with arguments relevant to the decision and not contained in the parties' written submissions.

Relevant statements are, for example, new or amended procedural submissions or the withdrawal thereof, the fresh submission or amendment or withdrawal of application documents, such as claims, description and drawings, and statements of surrender.

The essentials of the oral proceedings include new statements by the party or parties and by the member or members of the department concerning the subject-matter of the proceedings. In examination and opposition proceedings, the essentials are principally new statements arguing the presence or lack of novelty, inventive step and other patentability criteria.

Vague or general statements are to be avoided. Also, care must be taken to ensure that statements crucial to the decision are correctly recorded. In case of doubt, the record of such statements should be read out to the parties concerned before the decision is taken and



announced. If new facts or evidence are submitted during the oral proceedings, the minutes should make clear that the division has examined them under Art. 114(1). They should also indicate whether or not the Division, after having heard the parties, subsequently disregarded them under Art. 114(2).

The minutes should summarise the following elements, where present:

- (a) relevant arguments of the parties
- (b) substance of any new requests by the parties, and
- (c) presentation of the case by a member of the Division.

The parties' final requests should be recorded in the minutes immediately prior to the part indicating the decision or, if no final decision is taken, the outcome of the proceedings.

The minutes should also contain procedural information, such as how the proceedings are to be continued after closure of the oral proceedings.

If a decision is given, the wording of the operative part must be reproduced in the minutes.

If the exact wording of a statement or submission is not of importance, only a concise summary of the essentials should appear in the minutes.

The minutes with the result reached during the proceedings are communicated to the parties as soon as possible.

#### **10.4 Request for correction of minutes**

If a party to oral proceedings considers the minutes thereof not to fulfil the requirements of Rule 124, it may file a request to that effect, with a proposed correction, as soon as possible after receipt of the minutes in question.

The Examining/Opposition Division is competent to decide upon the request (T 1198/97, T 68/02 and T 231/99). In response to a request for correction the Division will either issue corrected minutes of the oral proceedings or dispatch a communication stating that the minutes already contain the essentials of the oral proceedings and the relevant statements of the parties and give reasoning thereto (see T 819/96). The communication from the Division cannot on its own be subject to an appeal (T 1198/97 and T 1063/02).

It is at the discretion of the writer of the minutes (and of the chairman who authenticates them) to decide what is considered essential and relevant in the meaning of Rule 124(1) (T 212/97). The minutes

should be corrected when they show deficiencies with regard to the aspects mentioned, for example if essential submissions or similarly important procedural statements are missing, or if they are incorrectly reflected in the minutes (T 231/99, T 642/97 and T 819/96).

## **11. Oral proceedings and interviews held by video-conference**

### **11.1 Requests for video-conferencing**

#### **11.1.1 Discretion regarding grant of requests for video-conferences**

Oral proceedings by video-conference are permitted only in the case of *ex parte* proceedings before an Examining Division. They are not allowed for opposition or PCT Chapter II cases or for the taking of oral evidence. Requests for them should be filed in the same way as other requests which are filed during pending proceedings. The request should specify which technology (ISDN or IP) the applicant intends to use.

The Examining Division should normally grant a request for oral proceedings by video-conference unless there are specific reasons for refusing it. Criteria for refusing are, for example, the unsuitability of the subject-matter of the application, the high complexity of the case, or the need to see or handle samples or models. The unavailability of video-conference rooms on the date set for the oral proceedings is also a reason for refusing the request.

If the Examining Division decides to refuse such a request, the requesting party must be informed in a communication setting out the reasons for the refusal. A purely systematic refusal, e.g. on the grounds that the video-conferencing system is not technically reliable, is not acceptable.

The request for holding an interview or oral proceedings as a video-conference should be filed as early as possible, preferably together with the request for an interview or oral proceedings. In case the request for oral proceedings by video-conference is made before the summons has been sent, the Division should exercise its discretion as stated above. If the subject-matter of the application is considered suitable for a video-conference, the Division should try to accommodate this wish when finding a suitable date. If the request for a video-conference cannot be granted, the reasons will be indicated in the summons to oral proceedings.

The Office also receives requests from applicants wishing to use the EPO video-conference facilities to hold proceedings at other EPO premises (e.g. when the applicant is in Munich and the proceedings are to be held in The Hague). The EPO video-conference facilities are for internal use only and such requests are to be refused with reference to OJ EPO 2012, 354, point 3.

### **11.1.2 Status of oral proceedings held by video-conference**

Oral proceedings held by video-conference are equivalent to oral proceedings held in the traditional manner on the premises of the EPO. Consequently a request for further oral proceedings before the same department (whether by video-conference or in any other form) may be rejected where the parties and the subject of the proceedings are the same (Art. 116(1)). The applicant will therefore no longer be required to file a waiver declaration.

## **11.2 Preparations for the video-conference**

### **11.2.1 Room reservations**

Rooms equipped for video-conferences are available at all locations. The formalities officer will take care of the room reservation as is the case for traditional oral proceedings.

For oral proceedings, the video-conference rooms should in principle be reserved for at least half a day. For interviews, a starting time and an estimated finishing time should be given.

It is important that the starting time and the video-conference dial-up number are communicated to the applicant by the formalities officer, as at the time arranged it is the applicant who dials the number to establish the video-conference link (the applicant making the request bears the transmission costs).

For interviews, the time at which the booking ends should also be communicated to the applicant.

### **11.2.2 Document camera**

A document camera can be made available in each video-conference room. With this device a copy of the document is transferred to the party's monitor. No paper copy of the document is produced with this device. Experience has shown that parties prefer a hard copy of documents, so it is preferable to fax or e-mail documents to each other.

## **11.3 Submissions**

### **11.3.1 Fax**

During the video-conference the participating party will be able to file submissions by fax. The examiner or Examining Division may in turn send documents to the party in the same manner. A clean copy of these submissions will need to be resent if the quality does not ensure suitable reproduction.

A fax machine is available in each video-conference room.

### **11.3.2 E-mail**

Where interviews and oral proceedings before an Examining Division are held as a video-conference, documents filed subsequently as

referred to in Rule 50 may be filed by e-mail (see Decision of the President of the EPO dated 20 April 2012 concerning the filing of documents by e-mail during interviews and oral proceedings held as a video-conference, OJ EPO 2012, 348). This does not apply to authorisations.

Where filed documents require signature, this signature may be applied to the attached document or to the text of the accompanying e-mail. The signature must take the form of a string of characters or of a facsimile signature. The string of characters which is selected by the signatory to provide evidence of his identity and of his intent to authenticate the message in question must clearly indicate the person's name and position. A facsimile signature must be the facsimile reproduction of the person's signature.

The documents are to be sent to the e-mail address indicated during the video-conference. Amended application documents are to be filed as attachments. Attachments containing these amended application documents must be in PDF format and must comply with the WIPO Standard for Filing and Processing in Electronic Form (Annex F). Where an attachment containing these amended application documents is not in PDF format or does not comply with the WIPO Standard or is illegible or incomplete, the Examining Division or the examiner must promptly inform the applicant during the video-conference. Where the deficiencies cannot be remedied during the video-conference or within the time limit set by the Examining Division, that document (or that part of the document which is illegible or incomplete) is deemed not to have been received.

Other attachments may be sent in any format which can be opened by the Examining Division or (in the case of an interview) the examiner and which can be reproduced in a legible form. Otherwise they are deemed not to have been filed.

No paper documents need be filed to confirm documents filed by e-mail, unless the applicant is invited to supply confirmation by the Examining Division or the examiner during the video-conference. In response to such an invitation, confirmation is to be supplied within a period of two months. If the applicant fails to comply with this invitation in due time, the documents are deemed not to have been received.

All submissions made by e-mail during a video-conference must be printed and annexed to the minutes of the interview or the oral proceedings, unless the exceptions under Rule 144 and the decision of the President of the EPO dated 12 July 2007 concerning documents excluded from file inspection apply (see A-XI, 2.1 and Special edition No. 3, OJ EPO 2007, J.3). A confidentiality note which is routinely included in e-mails is not to be regarded as a request to exclude these submissions from the public file. It must be borne in

mind that e-mail filing does not offer the same protection against access by third parties as EPO Online Filing.

#### **11.4 Technical problems**

The video-conference will automatically start when the applicant dials in. If the video-conference does not start at the arranged time, the Examining Division should contact the representative or his office by telephone. If the representative cannot be contacted, or if the connection is not established for technical reasons, the video-conference should be terminated and new summons should be issued for conventional oral proceedings.

Where technical problems occur such that the oral proceedings held by video-conference cannot be conducted openly and fairly, for example due to a total or partial breakdown in communication, the right to be heard might possibly be violated (Art. 113(1)). The applicant, due to the technical problems, might be taken by surprise by the grounds mentioned in an adverse decision on which he has not had an opportunity to comment. In such cases it is advisable to terminate the video-conference and to issue new summons for conventional oral proceedings. It should be noted that the EPO will not attempt to re-establish the line in case of technical problems, but the applicant may be contacted by phone and asked to do so.

Under these circumstances, it is at the discretion of the Examining Division to decide whether the new summons would be for a further video-conference or for conventional oral proceedings.

#### **11.5 Checking the identity of the representative**

If the representative is not personally known to at least one member of the Examining Division, it is necessary to check his identity. This can be done by requesting the representative to show his ID card with the document camera or to fax a copy of it. For data protection reasons, the faxed copy of the ID card should not be included in the file.

#### **11.6 Recording of the video-conference**

The recording of oral proceedings by the parties is not permitted (see Notice of the Vice-Presidents Directorates-General 2 and 3 dated 25 February 1986 concerning sound recording devices in oral proceedings before the EPO, OJ EPO 1986, 63). At the beginning of the video-conference the Chairman should therefore remind the applicant or his representative that recording of the video-conference is prohibited (see also E-II, 10.1).



## Chapter III – Taking and conservation of evidence

### 1. Taking of evidence by the departments of the EPO

#### 1.1 General remarks

Formal taking of evidence in accordance with Rule 117 will occur mainly in opposition proceedings and hardly ever before the Examining Division. The following Sections of this Chapter are therefore based primarily on opposition proceedings. However, they also apply *mutatis mutandis* to other proceedings and particularly to substantive examination.

Art. 117  
Rule 117

#### 1.2 Means of evidence

The party or parties may at any time during proceedings submit evidence in support of alleged facts (see E-II, 5, E-IX, 1.2, D-IV, 5.3 and 5.4, and D-VI, 3). This should be done at the earliest opportunity. When such evidence is such as should have been put forward at an earlier stage it is for the competent department to consider whether it is expedient (see E-V, 2) to allow the new evidence to be introduced.

Art. 117(1)

It would generally be desirable for a party to produce evidence in respect of all the facts alleged in support of his case, in order, for example, to show whether a particular technique was generally known to industry or whether there was any prejudice against a particular technique.

Facts adduced by a party will, however, normally be deemed true, even without supporting evidence, if it is clear that no doubts exist concerning them, if they do not contradict one another or if no objection is raised. In such cases the facts need not be supported by evidence.

There will however be occasions, particularly in opposition proceedings, in which the arguments of the party or parties must be supported by evidence. This will for example be the case where reference is made to prior art, for instance in the form of an oral description, a use or perhaps a company publication and there is some doubt as to whether, and if so when, such prior art was made available to the public.

The means of evidence which are admissible in proceedings before the EPO are (non-exhaustively) listed in Art. 117(1):

- production of documents;
- hearing the parties;
- hearing witnesses;

- sworn statements in writing;
- requests for information, for instance from a publisher concerning the date of publication of a book
- opinions by experts (see E-III, 1.8.1); and
- inspection.

The most appropriate way of obtaining evidence in the individual case depends on the facts which have to be proven and on the availability of the evidence. To prove prior use in an opposition, the opponent usually offers as evidence the production of documents, the hearing of witnesses or parties, or he presents sworn statements in writing. It is at the Opposition Division's discretion to evaluate this evidence, there being no fixed rules as to how any category of evidence should be judged (for the evaluation of evidence, see E-III, 4).

If the documents produced (e.g. patent documents) leave no doubt as to their contents and date of availability to the public and are more relevant for the patent in suit than other evidence offered, reasons of procedural efficiency may lead the Opposition Division to not pursue the other evidence at first.

If the testimony of a witness is offered, the Opposition Division may decide to hear this person in order to verify the facts for which this witness is brought forward, e.g. the prior use of the claimed product in an undertaking or the existence of an obligation to secrecy. For adequate substantiation the notice of opposition should make clear these facts, as witnesses are meant to serve for corroboration of facts brought forward, not for supplying these facts in place of the opponent. The above applies likewise to hearing the parties (see also E-III, 1.6).

The "sworn statements in writing" referred to in Art. 117(1)(g) are unknown in some national legal systems, which instead have their own instruments (see T 558/95).

Whether a written statement ("affidavit") is made under oath or not is only one of the criteria applied by the Opposition Division in its evaluation of the evidence adduced. Apart from its relevance for the case, other criteria are the relationship between the person making the statement and the parties to the proceedings, the personal interest of that person, the context in which the statement was made, etc. Such a statement does not go beyond its literal content and does not allow the Opposition Division to assess the associated or background factors. If the alleged facts are contested by the other party, the Opposition Division does not generally base its decision on such a statement, but summons the person making the statement as a witness, if so offered by the party. The ensuing hearing of the witness allows the Opposition Division and the parties to put



questions to the witness and thus enables the Opposition Division to establish the facts on the basis of that person's testimony. If that person is not offered as a witness, the Opposition Division will not pursue this evidence further.

Inspection will enable direct observations to be made and direct impressions to be formed of the object or process concerned. It may, for example, involve the demonstration of a product or process requested by the applicant or proprietor of the patent to substantiate the method of operation of the subject-matter of the patent where this is disputed by the Examining or Opposition Division.

Evidence in the form of documents normally stays on the file. Only exceptionally and on reasoned request can documents filed as evidence be returned unconsidered, e.g. if they were third-party statements filed in breach of a confidentiality agreement and the other parties agree to the request (see T 760/89).

### **1.3 Taking of evidence**

The department responsible for the taking of evidence in the form of a hearing of witnesses, parties and experts will, in substantive examination and opposition proceedings, be the Division before which the taking of evidence as part of oral proceedings would normally take place. If evidence is to be taken, the Examining or Opposition Division will normally have been enlarged to include a legally qualified member. The Division may commission one of its members to examine the evidence adduced. Generally, he will be the primary examiner under Art. 18(2) or 19(2). A member may, for example, be commissioned pursuant to Rule 119(1), for the purposes of an inspection, such as in the form of a demonstration of a process or the investigation of an object, particularly in undertakings located far away.

*Art. 117(2)  
Rules 118 to 120*

A member may also be commissioned to attend a court hearing pursuant to Rule 120(3), and put questions to the witnesses, parties and experts.

The language for taking evidence and writing the minutes is governed by Art. 14(3) (language of the proceedings) and Rule 4 (derogations from the provisions concerning the language of the proceedings in oral proceedings); see also E-II, 10.2 and E-IV.

### **1.4 Order to take evidence**

Where the competent department of the EPO considers it necessary to hear the oral evidence of parties, witnesses or experts or to carry out an inspection, it must make a decision to this end (order to take evidence), setting out the investigation which it intends to carry out, relevant facts to be proved and the date, time and place of the investigation. If oral evidence of witnesses and experts is requested by a party but the witnesses and experts are not simultaneously named, the party is requested, either prior to the issue of the order to

*Rule 117*

take evidence or in the order itself, to make known within a specified time limit the names and addresses of the witnesses and experts whom it wishes to be heard. The time limit to be computed in accordance with Rule 132(2) will be not less than two months and not more than four months, since the party concerned will normally know beforehand whom he wishes to be heard as a witness or expert.

*Art. 119* The order to take evidence must be notified to the parties. It may be appealed only together with the final decision, unless it allows separate appeal (see E-IX, 6).

### **1.5 Summoning of parties, witnesses and experts**

*Art. 119*  
*Rule 118(1) and (2)* The parties, witnesses and experts to be heard must be invited to appear to give evidence on the date fixed. The summons must be notified. At least two months' notice of a summons issued to a party, witness or expert to give evidence must be given, unless they agree to a shorter period. The summons must contain:

*Rule 118(2)(a)* (i) an extract from the order to take evidence, indicating in particular the date, time and place of the investigation ordered and stating the facts regarding which parties, witnesses and experts are to be heard;

*Rule 118(2)(b)* (ii) the names of the parties to the proceedings and particulars of the rights which the witnesses or experts may invoke (see E-III, 1.10); and

*Rule 118(2)(c)* (iii) an indication that the party, witness or expert may request to be heard by the competent court of his country of residence and a requirement that he informs the EPO within a time limit to be fixed by the EPO whether he is prepared to appear before it (see E-III, 3.2.2 (iii) and (iv)).

*Rule 119(3)* Even if evidence is not taken in oral proceedings, all parties to the proceedings may attend an investigation. Parties not summoned should be informed thereof within the period laid down in Rule 118(2), together with a statement that they may attend.

### **1.6 Hearing of parties, witnesses and experts**

#### **1.6.1 General remarks**

Where the Examining or Opposition Division holds hearings for the purpose of taking evidence (see E-III, 1.3) and if the case in question is expected to give rise to particular legal issues, it is advisable that the Division should be enlarged by the addition of a legally qualified examiner, if this is not already the case (see D-II, 2.2).

The evidence of witnesses is normally taken at oral proceedings.

The hearing will be either public or non-public, depending on the oral proceedings themselves (Art. 116(3) and (4)).

Where a hearing is held in connection with oral proceedings, the considerations set out in E-II, 8.2, 8.3, 8.9 and 8.10 are directly applicable, and where this is not the case they apply *mutatis mutandis*.

The hearing of an "expert" in the sense of Rule 117 requires as a precondition a decision to take evidence (see E-III, 1.4). This is different from hearing oral submissions by a person accompanying the representative during oral proceedings, which can be allowed at the discretion of the Division (see G 4/95 and E-II, 8.5).

#### **1.6.2 Witnesses and experts not summoned**

After opening the proceedings for the taking of evidence, the official in charge of the taking of evidence, i.e. in substantive examination and opposition proceedings the Chairman of the Division concerned or the member commissioned for the taking of evidence, will determine whether any party requests that any other person present but not summoned should be heard. If a party makes such a request he should briefly state why and to what purpose the person concerned should give testimony. The department in question will then decide on whether or not to grant the request (for the admission of facts or evidence not filed in due time see E-V, 2).

#### **1.6.3 Guidance to persons heard**

Before a party, witness or expert may be heard, he must be informed that the EPO may request the competent court in the country of residence of the person concerned to re-examine his evidence on oath or in an equally binding form.

*Rule 119(2)*

#### **1.6.4 Separate hearings**

Normally each witness must be heard separately, i.e. any other witnesses to be heard subsequently must not be present. This Rule does not apply to experts and to the parties. Witnesses whose statements conflict may be confronted with one another, i.e. each heard in turn in the presence of the other. The same applies to experts.

#### **1.6.5 Examination as to personal particulars**

The hearing will begin by the person giving evidence being asked his given names, family name, age, occupation and address. Witnesses and experts must also be asked whether they are related by blood or marriage with any of the parties and whether they have a material interest in a particular party being successful in the proceedings.

#### **1.6.6 Examination as to *res gestae***

The examination as to personal particulars will be followed by the examination as to *res gestae*. The person testifying should be instructed to give a full and logical account of what he knows concerning the subject-matter of the hearing. Further questions may have to be put to clarify and supplement statements and to establish on what the knowledge of the person testifying is based. Such

questions may be put by the member commissioned for the taking of evidence, where applicable, the Chairman or any other member of the department concerned. As regards the entitlement of other members of the Division to put questions, see E-II, 8.10. When formulating questions the same considerations apply as for the parties (see E-III, 1.6.7).

### **1.6.7 Entitlement of parties to put questions at hearings**

*Rule 119(3)*

The parties may put relevant questions to the testifying parties, witnesses and experts including, e.g. in opposition proceedings, witnesses and experts testifying on behalf of other parties. The official in charge of the taking of evidence will determine at what point in the proceedings such questions may be put.

Any doubts on the part of the competent department, e.g. the Opposition Division, or a party as to the admissibility of a question must be settled by the competent department. "Leading questions", i.e. questions which already contain the statement which one would like to hear from the witness, practically only requiring him to answer by "yes" or "no", should be avoided, because they do not allow to properly establish the witness' own recollection of the facts. Questions may further not be directed to facts which require no further discussion, which are in no way relevant to the subject-matter for which the taking of evidence has been ordered, or if they aim at establishing facts in respect of which no evidence has been offered. A decision to reject a question cannot be challenged. As regards the entitlement of other members of the Division to put questions, see E-II, 8.10.

### **1.7 Minutes of taking of evidence**

*Rule 124(1)*

Minutes of the taking of evidence must be drawn up as described in E-II, 10, subject to the following qualifications:

The minutes of the taking of evidence must, in addition to the essentials of the taking of evidence, also record as comprehensively as possible (almost verbatim as far as the essential points are concerned) the testimony of the parties, witnesses or experts.

*Rule 124(2)*

The minutes will normally be taken down by a member of the competent department carrying out the taking of evidence. The most efficient way of noting testimony is by way of dictation on to a dictating machine, in the process of which the person hearing the evidence will summarise the testimony in small sections, taking into account any objections raised by the person being heard, and dictate it in this form on to a dictating machine. If the dictated passage does not correspond in full to his testimony, the person being heard should raise any objections immediately. This should be pointed out to him at the beginning of his testimony. At the end of his testimony, he will be asked to approve the dictated minutes, which he will have listened to as they were dictated. His approval or any objections should be included in the dictated text. The dictated minutes are typed out and

the parties are provided with a copy as soon as possible. It is not necessary to play back the minutes or to obtain approval of them if the testimony has been recorded verbatim and directly, using technical means.

Where the taking of evidence includes an inspection, the minutes must record, in addition to the essentials of the proceedings, the results of the inspection.

In addition, the taking of evidence as well as oral proceedings (see E-II, 10.1) may be recorded on sound recording apparatus.

## **1.8 Commissioning of experts**

### **1.8.1 Decision on the form of the opinion**

If the competent department decides of its own motion to obtain an expert opinion (D-VI, 1, 6th paragraph), it will have to decide in what form it should be submitted by the expert whom it appoints. The opinion should be drawn up in written form only in cases where the competent department considers that this form is adequate in view of the content of the opinion and provided that the parties agree to this arrangement. As a rule, in addition to submitting a written opinion and introducing it orally, the expert will also be heard (see E-III, 1.6).

*Rule 121(1)*

A copy of the opinion must be submitted to the parties. The copy will be produced by the EPO.

*Rule 121(3)*

### **1.8.2 Objection to an expert**

The parties may object to an expert. Therefore, before commissioning an expert to make an opinion, the competent department should inform the parties of the expert whom it intends to ask to draw up an opinion and of the subject-matter of the opinion. The communication to the parties should state a time limit within which objections to the expert may be made. If the parties do object to an expert, the competent department will decide on the objection.

*Rule 121(4)*

### **1.8.3 Terms of reference of the expert**

The terms of reference of the expert must include: a precise description of his task, the period laid down for the submission of his opinion, the names of the parties to the proceedings and particulars of the rights which he may invoke under the provisions of Rule 122(2) to (4) (regarding travel and subsistence expenses and fees, see E-III, 1.10).

*Rule 121(2)(a)-(d)*

## **1.9 Costs arising from oral proceedings or taking of evidence**

As a rule, each party to proceedings before the EPO meets the costs he has incurred. This principle notwithstanding, the competent body in the opposition proceedings may for reasons of equity (see D-IX, 1.4) decide to apportion in some other way the costs arising for the parties in respect of oral proceedings or taking of evidence (see D-IX, 1) and the costs arising for the EPO in respect of

*Art. 104(1) and (2)  
Rule 122(1) and (2)*

witnesses and experts (see E-III, 1.10). The competent body may make the taking of evidence conditional upon deposit with the EPO by the party who requested the evidence to be taken of a sum the amount of which is to be fixed by reference to an estimate of the costs. This procedure should be applied where at the request of a party to grant or opposition proceedings evidence is to be taken by hearing witnesses or seeking an expert opinion, unless no costs will arise because the witness or expert has waived his right to indemnification. If the party requesting evidence to be taken does not comply with the requirement of making such a deposit, the evidence need not be taken. In opposition proceedings the party requesting the evidence bears the costs of indemnifying witnesses or experts, unless for reasons of equity in individual cases other arrangements are made for the apportionment of costs under Art. 104(1) in conjunction with Rule 88. Any shortfall between the deposit lodged and the amounts payable by the EPO under Rule 122(4), 2nd sentence, is fixed by the EPO of its own motion. Any unused amount of the deposit lodged is refunded. The Office's internal costs arising through oral proceedings or taking of evidence, e.g. any associated staff travel and subsistence costs, are to be met by the EPO itself.

## **1.10 Entitlements of witnesses and experts**

### **1.10.1 Expenses for travel and subsistence**

*Rule 122(2)*

Witnesses and experts who are summoned by and appear before the EPO are entitled to appropriate reimbursement, by the EPO, of expenses for travel and subsistence (see E-III, 1.10.3). This applies even if the witnesses or experts are not heard, e.g. where evidence is to be produced concerning an alleged prior use and shortly before the taking of evidence such prior use is substantiated by a document already published. Witnesses and experts may be granted an advance on their expenses for travel and subsistence. Witnesses and experts who appear before the EPO without being summoned by it but are heard as witnesses or experts will also be entitled to appropriate reimbursement of expenses for travel and subsistence.

### **1.10.2 Loss of earnings, fees**

*Rule 122(3)*

Witnesses entitled to reimbursement of travel and subsistence expenses are also entitled to appropriate compensation, by the EPO, for loss of earnings, and experts to fees from the EPO for their work (see E-III, 1.10.3). These payments must be made to the witnesses and experts after they have fulfilled their duties or tasks.

### **1.10.3 Details of the entitlements of witnesses and experts**

*Rule 122(4)*

The Administrative Council of the European Patent Organisation has laid down the details governing the entitlements of witnesses and experts set out under E-III, 1.10.1 and 1.10.2, see document CA/D 5/77 (published in Supplement to OJ EPO 1/2010, 71). Payment of amounts due must be made by the EPO.

## **1.11 Models**

### **1.11.1 When may models be submitted?**

The EPC makes no express provision for the submission of models, but there is nothing to stop a party from submitting one himself. Models are not part of the application or patent, and therefore cannot be used to disclose the invention (Art. 83).

Models may be useful in EPO proceedings if they serve to substantiate the patentability of an invention, e.g. by showing that a given device actually works or does so particularly advantageously. Models may also be filed, e.g. in opposition proceedings, to illustrate the state of the art, especially prior use under Art. 54(2). Models as items for inspection therefore constitute evidence under Art. 117(1)(f).

### **1.11.2 Must the model be considered?**

The Division decides whether it needs to take evidence by inspection (Rule 117, first sentence), i.e. whether to consider the model at all.

Even if the Division does inspect the model, the Office is not obliged to keep it. The party will keep the model, in his own interest, for subsequent proceedings.

### **1.11.3 Keeping the model**

Thus practical considerations determine whether the EPO keeps a model if the party does not wish to do so. This decision is taken by the Division. However, models which would require special precautions or security measures if kept in the EPO must be returned at once. Generally, the EPO should keep models admitted as evidence only if they are crucial to the decision.

### **1.11.4 Procedure**

On receipt, the model is sent to the primary examiner, who decides whether to keep it. Models useful in examination proceedings are likely to be useful for opposition proceedings too. They should therefore be kept until the opposition period expires or a final decision is taken on any opposition filed.

The formalities officer is responsible for implementing the decision to keep or return the model. If the model is to be kept, the formalities officer notes this on the label. If it is to be returned, the formalities officer informs the submitter accordingly and notes the date of return on the label.

## **1.12 Video recordings**

A party to the proceedings may request that a video recording be shown at the oral proceedings. Such a request should include the recording as such as well as specifying the type of equipment needed.

If video recordings are submitted, the Division decides whether showing them will assist the proceedings. Video data carriers should always be kept if the Division has looked at them.

## 2. Conservation of evidence

### 2.1 Requirements

Rule 123(1)

On request, the EPO may, without delay, hear oral evidence or conduct inspections, with a view to conserving evidence of facts liable to affect a decision, where there is reason to fear that it might subsequently become more difficult or even impossible to take evidence. This could for example be the case where an important witness is about to emigrate to a distant country or where perishable matter, e.g. a food-stuff, is adduced as involving a use made accessible to the public.

### 2.2 Request for the conservation of evidence

Rule 123(2)

The request for the conservation of evidence must contain:

Rule 123(2)(a)

(i) the name, address and nationality of the person filing the request and the State in which his residence or principal place of business is located, in accordance with the provisions of Rule 41(2)(c);

Rule 123(2)(b)

(ii) sufficient identification of the European patent application or European patent in question;

Rule 123(2)(c)

(iii) the designation of the facts in respect of which evidence is to be taken;

Rule 123(2)(d)

(iv) particulars of the way in which evidence is to be taken; and

Rule 123(2)(e)

(v) a statement establishing a *prima facie* case for fearing that it might subsequently become more difficult or impossible to take evidence.

Rule 123(3)

The request is not deemed to have been filed until the fee for conservation of evidence has been paid.

### 2.3 Competence

Rule 123(4)

The decision on the request and any resulting taking of evidence are incumbent upon the department of the EPO required to take the decision liable to be affected by the facts to be established.

Responsibility for the decision and the taking of evidence will therefore normally rest with:

(i) the Examining Division, from the date of filing until the date of the decision on the granting of the patent;



- (ii) the Opposition Division, from the latter date until expiry of the time allowed for filing notice of opposition and during opposition proceedings; and
- (iii) the Board of Appeal, from the date of a final decision by the Opposition Division until it becomes legally binding or while appeal proceedings are pending.

#### **2.4 Decision on the request and the taking of evidence**

The competent department must decide upon the request without delay. If it grants the request, it must also immediately make a decision on the taking of evidence. *Rule 123(1)*  
*Rule 117*

The provisions with regard to the taking of evidence in proceedings before the EPO are applicable. *Rule 123(4)*

The date on which the measures are to be taken must therefore be communicated to the applicant for or proprietor of the patent and the other parties in sufficient time to allow them to attend. They may ask relevant questions. *Rule 123(1)*  
*Rule 118(2)*  
*Rule 119(3)*

### **3. Taking of evidence by courts or authorities of the Contracting States**

#### **3.1 Legal co-operation**

Upon receipt of letters rogatory from the EPO, the courts or other competent authorities of Contracting States will undertake, on behalf of the EPO and within the limits of their jurisdiction, any necessary enquiries. *Art. 131(2)*

#### **3.2 Means of giving or taking evidence**

##### **3.2.1 Taking of evidence on oath**

The principal case where evidence is taken by a competent court will be the hearing of parties, witnesses or experts. In such instances the competent department may request the competent court to take the evidence on oath or in an equally binding form. *Rule 120(3)*

##### **3.2.2 Evidence taken by a competent court**

The competent department will, if necessary, request a competent court to take evidence, where appropriate under oath, where: *Rule 120(3)*

- (i) the taking of evidence by that department would entail disproportionately high travelling costs or the taking of evidence by the competent court appears to be appropriate on other grounds;
- (ii) the competent department considers it advisable for the evidence of a party, witness or expert it has heard to be re-examined under oath or in an equally binding form (see E-III, 3.2.1); *Rule 120(2)*

*Rule 120(1)* (iii) there has been no reply to the summons by the expiry of a period fixed by the competent department in the summons (see E-III, 1.5(iii)); or

*Rule 120(1)*  
*Rule 150(3)* (iv) a party, witness or expert who has been summoned before that department requests the latter in accordance with E-III, 1.5(iii), to allow his evidence to be heard by a competent court in his country of residence. If the party, witness or expert simply refuses to be heard by the responsible Division, he should be notified that the competent national court will have the relevant national legal possibilities to oblige him to appear and to testify.

### **3.3 Letters rogatory**

*Rule 150(2)* The EPO must draw up letters rogatory in the language of the competent authority or must attach to such letters rogatory a translation into the language of that authority.

*Rule 150(1)* Letters rogatory should be addressed to the central authority designated by the Contracting State.

### **3.4 Procedures before the competent authority**

*Rule 150(5)* The EPO must be informed of the time when, and the place where, the enquiry is to take place and must inform the parties, witnesses and experts concerned.

*Rule 120(3)*  
*Rule 150(6)* If so requested by the EPO, the competent authority shall permit the attendance of members of the department concerned and allow them to question any person giving evidence either directly or through the competent authority. Whether the parties may put questions or not will depend on the laws of the Contracting States concerned.

### **3.5 Costs of taking evidence**

*Rule 150(7)* The execution of letters rogatory does not give rise to any reimbursement of fees or costs of any nature. Nevertheless, the State in which letters rogatory are executed has the right to require the European Patent Organisation to reimburse any fees paid to experts and interpreters and the costs incurred as a result of the attendance of members of the competent department when evidence is taken.

### **3.6 Taking of evidence by an appointed person**

*Rule 150(8)* If the law applied by the competent authority obliges the parties to secure evidence and the authority is not able itself to execute the letters rogatory, that authority may, with the consent of the competent department, appoint a suitable person to do so. When seeking the consent of the department concerned, the competent authority must indicate the approximate costs which would result from this procedure. If the competent department gives its consent, the European Patent Organisation must reimburse any costs incurred; without such consent, the Organisation is not liable for such costs.

## 4. Evaluation of evidence

### 4.1 General remarks

The competent department must examine whether the conclusions drawn by the parties from the evidence and facts are correct and give grounds for the conclusions it itself freely arrives at on the basis of the situation as a whole.

The state of the art to be taken into consideration in individual cases for the purposes of Art. 54 is that laid down in G-IV, 1 to 5 and 7, and G-V.

The competent department is not obliged to take into consideration any facts or evidence not presented by the parties in due time, except within the limits specified in E-V, 2.

### 4.2 Types of evidence

When evaluating submissions made, the difference between facts, evidence and arguments should be observed.

#### *Example:*

The opponent asserts that the preamble to claim 1 is described in document A, the characterising portion in document B (facts). To prove this, he submits the documents (evidence). He then contends that the method claimed does not involve an inventive step, because the skilled person, on the basis of his common general knowledge, would have combined them in such a way as to arrive at the subject-matter of claim 1 (argument).

Evidence admissible in EPO proceedings is not confined to that listed in Art. 117(1). "Taking of evidence" within the meaning of Art. 117 comprises the submission or gathering of evidence of any kind, particularly the filing of documents.

Pure arguments are not evidence (see T 642/92).

### 4.3 Examination of evidence

When evidence is submitted, the first thing to establish is what fact is being asserted, and then whether that fact is relevant to the decision. If not, the assertion is no longer considered and the evidence is not examined further. If the alleged fact is relevant, the next point is whether it is proven by the evidence submitted.

When evidence is examined, since the EPC says nothing about how the outcome of taking of evidence should be assessed, the principle of unfettered consideration applies. This means that its content and its significance for the proceedings are assessed in the light of the particular circumstances of each individual case (e.g. time, place, type of evidence, position of witness in firm, etc.). The principle of unfettered consideration also means that EPO departments are empowered to evaluate evidence submitted by the parties in any

appropriate manner, or indeed to disregard it as unimportant or irrelevant. In particular it has to be decided on a case-by-case basis when a particular piece of evidence is sufficient.

When deciding whether an alleged fact is accepted, the Division may use the criterion of the "balance of probabilities", which means that it is satisfied that one set of facts is more likely to be true than the other. Furthermore, the more serious the issue, the more convincing must be the evidence to support it (see T 750/94). For example, if a decision might result in revocation of the patent in a case concerning alleged prior use, the available evidence has to be very critically and strictly examined. In particular, in case of alleged prior use for which little if any evidence would be available to the patentee to establish that no prior use had taken place, the Division should cede to the stricter criterion close to absolute conviction, i.e. beyond any reasonable doubt (see T 97/94).

When parties make conflicting assertions, the Division must decide which evidence is the most convincing. If it cannot establish which allegation is right on the basis of the evidence put forward, it must decide on the basis of the burden of proof, i.e. against the party bearing that burden but unable to prove its point convincingly.

#### **4.4 Asking for evidence**

When pointing out that it cannot accept a line of argument because certain facts have not been proven, the Division must do so as neutrally and objectively as possible. In particular, it may neither

- (a) require a specific kind of evidence (see T 474/04), nor
- (b) prescribe the content of the evidence (e.g. the wording of a sworn statement in writing (see T 804/92)).

The taking of evidence in each of the forms listed in Art. 117 is done at the discretion of the EPO department in question, i.e. only if that department considers it necessary. This will be the case, for example, if a fact relevant to the decision needs to be proven.

#### **4.5 Evaluation of the testimony of a witness**

After the witnesses have been heard, the party or parties must be given an opportunity of making observations. The observations may be made either in oral proceedings following the taking of evidence or exceptionally in writing after transmission of the minutes of the taking of evidence. The decision on this matter will rest with the competent department. The parties may file requests accordingly.

Only when this has been done should the competent department proceed to evaluate the evidence. Where a witness's testimony which is crucial to the decision has been challenged by a party but the department regards it as credible, or where a witness's oral or written testimony is disregarded in its decision as being not credible, the department concerned must state the grounds for its view in its decision.

In evaluating a witness's oral or written testimony, special attention should be paid to the following:

- (i) what is important is what a witness can relate concerning the points at issue on the basis of his own knowledge or views, and whether he has practical experience in the field in question. Second-hand assertions based on something heard from third parties are for the most part worthless on their own. It is also important from the point of view of the evaluation whether the witness was involved in the event himself or only knows of it as an observer or listener;
- (ii) in the event of long intervals of time (several years) between the event in question and the testimony, it should be borne in mind that most people's power of recall is limited without the support of documentary evidence;
- (iii) where testimony appears to conflict, the texts of the statements concerned should be closely compared with one another.

Apparent contradiction in the testimony of witnesses may sometimes be resolved in this way. For example, a close examination of apparently contradictory statements by witnesses as to whether a substance X was commonly used for a particular purpose may show that there is in fact no contradiction at all, in that while one witness was saying specifically that substance X was not used for that particular purpose, the other witness was saying no more than that substances like X, or a certain class of substances to which X belonged, were commonly used for this particular purpose without intending to make any statement regarding substance X itself;

- (iv) an employee of a party to the proceedings can be heard as a witness (see T 482/89). The possible partiality of a witness determines how the evidence is assessed, not whether it is admissible (see T 443/93).

#### **4.6 Evaluation of the testimony of parties**

Oral or written evidence given by parties or their refusal to give evidence should be evaluated in the light of their special interest in the matter. Because of their special interest, the testimony of parties possibly should not be evaluated on the same level as that of neutral witnesses. This applies above all where parties have been present when witnesses have been heard and have ascertained the attitude of the competent department. The considerations set out in E-III, 4.5 (Evaluation of the testimony of a witness) apply *mutatis mutandis*.

#### **4.7 Evaluation of an expert opinion**

The competent department must examine whether the grounds on which an expert opinion is based are convincing. Notwithstanding its discretion in the evaluation of evidence, it may not disregard an expert opinion in the absence of grounds based on adequate specialist knowledge of its own or of another expert, irrespective of whether the latter expert is an independent expert commissioned under Rule 121 or an expert who testifies at the request of one of the parties.

#### **4.8 Evaluation of an inspection**

In the case of a demonstration, a specific test programme under specific conditions should be agreed in advance. During the demonstration itself care must be taken to ensure that the characteristics or conditions of operation claimed for the invention are complied with. Where an invention is compared under test with an item forming part of the state of the art, as far as possible the same or comparable test conditions must be applied to both.

## Chapter IV – Derogations from the language of the proceedings in oral proceedings

### 1. Use of an official language

Any party to oral proceedings before the EPO may, in lieu of the language of the proceedings, use one of the other official languages of the EPO, on condition that such party either gives notice to the EPO at least one month before the date laid down for such oral proceedings or makes provision for interpreting into the language of the proceedings. In the former case, it is the responsibility of the EPO to provide for interpretation at its own expense.

*Rule 4(1) and (5)*

A party must be clear as to which official language it wishes to use. It then has a right to both speak and hear that language, as long as the conditions of Rule 4 have been fulfilled. The party does not, however, have a right to have one language in which it will speak and a different language in which it will hear (see T 774/05).

The language of the proceedings as defined in Art. 14(3) cannot be changed. This means that any amendments to the application or patent have to be filed in the language of the proceedings (Rule 3(2)).

If at all possible, the Division should try to manage without interpreters (this question normally arises only in opposition proceedings). The parties' summonses are therefore accompanied by information which encourages them to agree how this can be achieved.

It may be possible to agree to limit the interpreting to "one-way", i.e. from one language into another but not the other way round. If a comment made in one language has clearly been misunderstood, the Division should be prepared to clarify it in another. Under no circumstances however should its members officially act as interpreters.

### 2. Language of a Contracting State or other language

Any party may likewise use one of the official languages of the Contracting States, other than English, French or German, on condition that he makes provision for interpreting into the language of the proceedings. However, if the parties and the EPO agree, any language may be used in oral proceedings without interpreting or prior notice.

*Rule 4(1) and (4)*

### 3. Exceptions from sections 1 and 2

Derogations from the provisions of Rule 4(1) are permitted, and these are at the discretion of the EPO. Clearly such permission must depend on the circumstances of the individual case. It may, for example, be envisaged that a party is unable to give one month's notice through no fault of his own, and, although he has made arrangements for an interpreter, the latter is unable (e.g. through

*Rule 4(1)*

illness) to attend. If, in such circumstances, the EPO is unable to provide for interpreting, it should postpone the oral proceedings if they occur at the examination stage. However, in opposition proceedings, the oral proceedings should continue if the parties agree and the employees of the EPO involved in the proceedings can cope with the language. In other cases, the EPO should postpone the oral proceedings and any costs incurred by the innocent party as a result of the postponement should be a matter for apportionment under Art. 104.

#### **4. Language used in the taking of evidence**

*Rule 4(3)*

When the evidence is being taken, a party, witness or expert who is unable to express himself adequately in English, French or German or in any other official language of the Contracting States is permitted to use another language. The EPO is responsible for interpreting into the language of the proceedings, assuming that this is necessary, if the evidence is taken at the request of the EPO itself. However, if the taking of evidence follows a request by a party to the proceedings, the use of a language other than English, French or German should be allowed only if that party provides for interpreting into the language of the proceedings or, at the discretion of the EPO, into any one of English, French or German. This discretion should be exercised in opposition proceedings only if the other parties agree.

#### **5. Language used by employees of the EPO**

*Rule 4(2)*

Employees of the EPO may use any one of English, French or German in the course of all oral proceedings. If, prior to the commencement of oral proceedings, an employee is aware that he may need to use a language other than the language of the proceedings, he should ensure that the parties involved are informed of his intention. However, employees should not depart from the language of the proceedings without good reason, and unless the parties involved are competent in the language used and express no objection, the EPO should provide for interpreting into the language of the proceedings at its own expense.

#### **6. Language used in the minutes**

Where the official language actually employed in oral proceedings is not the language of the proceedings as defined in Art. 14(3), if the Examining or Opposition Division considers it appropriate and subject to explicit agreement of all parties concerned, the minutes may be recorded in the language actually employed in the oral proceedings.

Prior to the agreement of the parties, their attention should be drawn to the fact that the EPO will not provide translations of the minutes into the language of the proceedings as defined in Art. 14(3). This condition, as well as the declaration of agreement of the party or parties, should be recorded in the minutes.

Statements made in English, French or German are entered in the minutes of the proceedings in the language employed.



Statements made in any other language must be entered in the official language into which they are translated. Amendments to the text of the description or claims of a European patent application or European patent made during oral proceedings must be entered in the minutes in the language of the proceedings. If the proceedings are conducted in a language other than English, French or German and no interpretation is effected, statements should be entered in the minutes in the language employed and the EPO should subsequently provide in the minutes a translation into the language of the proceedings.



## **Chapter V – Examination by the EPO of its own motion; facts, evidence or grounds not submitted in due time; observations by third parties**

### **1. Examination by the EPO of its own motion**

#### **1.1 General remarks**

In proceedings before it, the EPO examines the facts of its own motion; it is not restricted in this examination to the facts, evidence and arguments provided by the parties and the relief sought. This principle of examination by the EPO of its own motion must be complied with by the competent department during all proceedings pending before it. Thus, once proceedings have been initiated, e.g. once a valid request for examination has been filed or an admissible notice of opposition has been filed (although it may subsequently be withdrawn), if there is reason to believe, e.g. from personal knowledge or from observations presented by third parties, that there are facts and evidence not yet considered in the proceedings which in whole or in part prejudice the granting or maintenance of the European patent, such facts and evidence must be included in those examined by the EPO of its own motion pursuant to Art. 114(1). See D-V, 2, for the extent of substantive examination of the facts and evidence in opposition proceedings.

*Art. 114(1)*

#### **1.2 Limits on the obligation to undertake examination**

However, the obligation to undertake such examination should be kept within limits in the interests of procedural expediency. For example, in opposition proceedings, an offer to prove that an alleged public prior use took place should not be taken up if the opponent making such an allegation has ceased to participate in the proceedings and the necessary evidence cannot be easily obtained at a reasonable cost.

The unity of the subject-matter of the European patent is not to be examined in opposition proceedings (G 1/91, see D-V, 2.2).

### **2. Late filed submissions**

(Where submissions of the parties are filed late in respect of the date indicated in the note to the summons to oral proceedings pursuant to Rule 116(1), refer primarily to E-II, 8.6.)

The EPO may disregard facts or evidence (e.g. publications) which are not submitted in due time by the parties concerned.

*Art. 114(2)*

This also applies to grounds for opposition not submitted in due time, together with supporting facts and evidence in opposition proceedings (see D-V, 2.2). Note in this respect that according to G 1/95 and G 7/95, Art. 100(a) does not constitute one single ground for

opposition, but has to be considered a collection of individual grounds for opposition, i.e. individual legal bases for objection to the maintenance of a patent. This applies not only to distinctly different objections, such as subject-matter which is not patentable (Art. 52(2)) as compared to subject-matter which is not capable of industrial application (Art. 57), but also to an objection for lack of novelty as opposed to an objection for lack of inventive step.

New arguments based on facts, evidence and grounds constituting the legal and factual framework of the opposition cannot be disregarded.

In deciding whether to admit facts, evidence or grounds for opposition not filed in due time, their relevance to the decision, the state of the procedure and the reasons for belated submission are to be considered. If examination of late-filed grounds for opposition, late-filed facts or late-filed evidence reveals without any further investigation (i.e. *prima facie*) that they are relevant, i.e. that the basis of the envisaged decision would be changed, then the competent department has to take such grounds, facts or evidence into consideration no matter what stage the procedure has reached and whatever the reasons for belated submission. In that case, the principle of examination by the EPO of its own motion under Art. 114(1) takes precedence over the possibility of disregarding facts or evidence under Art. 114(2) (see T 156/84). Note, however, the limits on the obligation to undertake further examinations as set out in E-V, 1.2. Otherwise, the department should inform the party concerned in the decision, with due regard to Art. 113(1) (see T 281/00), that the facts, evidence and/or grounds for opposition were not submitted in due time and, since they are not relevant to the decision, will be disregarded pursuant to Art. 114(2). On the apportionment of any costs arising from the late filing of facts and evidence, see D-IX, 1.4.

The latest date up to which submissions can be considered at all is the date on which the decision is handed over to the EPO's internal postal service for transmittal to the parties (see G 12/91).

The above applies in written proceedings; in oral proceedings submissions can only be considered up to the pronouncement of the decision (see E-II, 9).

### **2.1 General examples in opposition proceedings**

As far as the assessment of late filing in opposition proceedings is concerned, the rulings of the Enlarged Board of Appeal in G 9/91 and G 10/91 apply. According to these decisions, in principle, the opposition is to be examined to the extent and on the grounds submitted during the period for opposition. Under Art. 114(1) the Opposition Division may go beyond this framework if *prima facie* maintenance of the patent is prejudiced. The principles developed by the Enlarged Board with respect to new grounds also apply to

late-filed facts and evidence (see T 1002/92). Therefore late-filed facts and evidence are to be admitted into the proceedings only if they are *prima facie* relevant, i.e. if they would change the envisaged decision, see E-V, 2.

If a patent proprietor replies to a notice of opposition by amending the patent, such a request for amendment cannot be considered as late-filed and has to be admitted into the proceedings (Rule 79(1)).

Thus, if the proprietor limits the patent to the subject-matter of a dependent claim as granted, new facts and evidence submitted by the opponent in reply to this amendment should as a general rule be treated as late-filed and only be admitted under Art. 114(1) if they are *prima facie* relevant because the opponent should have been prepared for this type of amendment and should have provided material during the nine-month opposition period.

If the new facts and submissions are not *prima facie* relevant, they should be disregarded under Art. 114(2). An exception to this rule would be where the patent specification as granted contained a large number of dependent claims and the opponent could not reasonably have been expected to deal with all of them in the notice of opposition.

If, however, the proprietor amends the patent at an early stage of the proceedings in a manner not foreseeable by the opponent, e.g. by taking up features disclosed in the description, the opponent should have the opportunity to provide new facts and evidence, i.e. possibly even to submit a new ground for opposition and new documents. Such a submission would have to be admitted into the proceedings because the subject of the proceedings has changed. At a late stage in the proceedings such unforeseeable amendments would be subject to the criterion of "clear allowability" (see H-II, 2.7.1) .

## **2.2 Examples concerning oral proceedings in opposition procedure**

If oral proceedings are arranged, the Opposition Division issues a summons together with an annex drawing attention to the points to be discussed (Rule 116(1)) and normally containing the Division's provisional and non-binding opinion (see D-VI, 3.2). The following situations may arise:

- (a) The Division should admit new facts and evidence only if they are *prima facie* relevant. Furthermore, if new facts and evidence are admitted under Art. 114(1) because they are *prima facie* relevant, a request of the proprietor for corresponding amendment would have to be admitted even if submitted after the above final date, because the subject of the proceedings has changed.

It should however be noted that if in the provisional and non-binding opinion the Division reaches the conclusion that maintenance of the patent is not prejudiced by the facts and evidence submitted so far by the opponent, this fact *per se* does not give the opponent the right to have new facts and evidence admitted into the proceedings, even if submitted before the final date fixed under Rule 116(1).

If during the oral proceedings the Opposition Division, contrary to its provisional opinion set out in the annex to the summons, reaches the conclusion that the patent should be revoked, a request of the proprietor for (further) amendment should be admitted into the proceedings (see E-II, 8.6).

- (b) If the Opposition Division states in the annex to the summons that the patent is likely to be revoked, requests for amendment should be admitted if they are filed before the final date fixed under Rule 116. If such requests relate to subject-matter not covered by the claims as granted, the subject of the proceedings has changed. Consequently new facts and evidence submitted by the opponent in response to these requests should be admitted into the proceedings, even if they arrive after the final date set under Rule 116.

However, if the proprietor's requests relate to amendments based only on claims as granted and are reasonable in number, new facts and evidence submitted by the opponent should be treated as late-filed even if submitted before the final date, i.e. they should be admitted only if they are *prima facie* relevant. Relevant facts and evidence submitted at a late stage of the proceedings, possibly not until the oral proceedings for example, could give rise to a decision on apportionment of costs, see D-IX, 1.2, if so requested by the proprietor.

- (c) If the Opposition Division states in the annex to the summons that the patent is likely to be revoked, and the proprietor in response submits amendments after the final date set under Rule 116(1), possibly not until the oral proceedings, the Division could, in principle, treat such requests as late-filed and apply the criterion of "clear allowability" (see H-II, 2.7.1) in judging whether they should be admitted into the proceedings. However, the Division should consider admitting such requests into the proceedings if they relate to the subject-matter of dependent claims as granted.

It may only become apparent in the oral proceedings that the pending request submitted to overcome grounds for opposition is not allowable under the EPC. The opponent should always expect to have to discuss subject-matter based on dependent claims as granted if they are reasonable in number.

However, if late-filed requests are based on subject-matter not previously covered by the claims, they will normally not be admitted into the proceedings also for reasons of procedural efficiency. Admission of such requests could give rise to a postponement of oral proceedings, and to a decision on apportionment of costs.

### 3. Observations by third parties

Following publication of the European patent application under Art. 93, any person may present observations concerning the patentability of the invention. Although lack of novelty and/or inventive step are the most common observations, third-party observations may also be directed to clarity (Art. 84), sufficiency of disclosure (Art. 83), patentability (Art. 52(2) and (3), 53 or 57) and unallowable amendments (Art. 76(1), 123(2)).

*Art. 115*  
*Rule 114(1)*

Such observations must be filed in writing in English, French or German and must include a statement of the grounds on which they are based. The person filing them may not be a party to the proceedings before the EPO. The web interface provided by the EPO is the preferred means of filing such observations (see OJ EPO 2011, 418 and 420).

Documentary evidence and, in particular, publications submitted in support of the arguments may be filed in any language. However, the EPO may request that a translation into one of its official languages be filed within a period to be specified; otherwise the evidence will be disregarded.

*Rule 3(3)*

Although the third party is sent acknowledgment of the receipt of his observations, the EPO does not specifically inform him of any further action it takes in response to them. However, the outcome of the evaluation by the competent Division will briefly be indicated in the respective office action from the EPO (e.g. in a communication or in the intention to grant) and will thus be visible to the public.

The Office will make every effort to issue the next office action within three months of receipt of third-party observations under Art. 115 by the Examining Division, provided the observations are substantiated and have not been filed anonymously.

The observations are communicated to the applicant or proprietor without delay and he may comment on them. If they call into question the patentability of the invention in whole or in part, they must be taken into account in any proceedings pending before a department of the EPO until such proceedings have been terminated, i.e. they must be admitted to the proceedings. If the observations relate to alleged prior art available other than from a document, e.g. from use, this should be taken into account only if the alleged facts either are not disputed by the applicant or proprietor or are established beyond reasonable doubt. Observations by third parties received after the

*Rule 114(2)*

conclusion of proceedings will not be taken into account and will simply be added to the non-public part of the file.



## Chapter VI – Interruption and stay of the proceedings

### 1. Interruption

#### 1.1 Cases in which the proceedings may be interrupted

Pursuant to Rule 142(1), proceedings before the EPO are interrupted in one of the following events: *Rule 142(1)*

- (i) in the event of the death or legal incapacity of the applicant for or proprietor of a European patent or of the person authorised by national law to act on his behalf. To the extent that the above events do not affect the authorisation of a representative appointed under Art. 134, proceedings will be interrupted only on application by such representative; *Rule 142(1)(a)*
- (ii) in the event of the applicant for or proprietor of a European patent, as a result of some action taken against his property, being prevented by legal reasons from continuing the proceedings before the EPO; or *Rule 142(1)(b)*
- (iii) in the event of the death or legal incapacity of the representative of an applicant for or proprietor of a European patent or of his being prevented for legal reasons resulting from action taken against his property from continuing the proceedings before the EPO. *Rule 142(1)(c)*

In principle, the EPO interrupts proceedings pursuant to Rule 142 ex officio. In the case of Rule 142(1)(a) last sentence, however, proceedings are interrupted on request only.

#### 1.2 Responsible department

The Legal Division of the EPO bears sole responsibility for the interruption and resumption of proceedings under Rule 142 (Decision of the President of the EPO dated 21 November 2013, OJ EPO 2013, 600). *Art. 20*

#### 1.3 Date of interruption

An interruption is registered (in general retroactively) with legal effect from the date of the occurrence of the event. In cases where proceedings are interrupted on request, the interruption is effected as from the date of receipt of the request at the EPO.

The parties are informed of the interruption of proceedings and the reasons for it. The date of interruption as well as the date of resumption of proceedings are recorded in the European Patent Register. *Rule 143(1)(t)*

#### 1.4 Resumption of proceedings

*Rule 142(2)*

When, in the cases referred to in Rule 142(1)(a) or (b), the EPO has been informed of the identity of the person authorised to continue the proceedings before the EPO, it notifies that person and, where applicable, any third party, that the proceedings will be resumed as from a specified date. The date should be set in such a manner as to allow this person to familiarise himself with the matter.

Communications and decisions of the EPO which have been notified during the interruption period are to be regarded as null and void and will be notified anew after resumption of proceedings by the responsible department.

*Rule 142(3)*

In the case referred to in Rule 142(1)(c), the proceedings will be resumed when the EPO has been informed of the appointment of a new representative of the applicant or when the EPO has notified to the other parties the communication of the appointment of a new representative of the proprietor of the patent. If, the EPO has not been informed of the appointment of a new representative within a period of three months after the beginning of the interruption of the proceedings, it communicates to the applicant for or proprietor of the patent:

*Rule 142(3)(a)*

(i) where Art. 133(2) (mandatory appointment of a representative) is applicable, that the European patent application will be deemed to be withdrawn or the European patent will be revoked if the information is not submitted within two months after this communication is notified; or

*Rule 142(3)(b)*

(ii) where Art. 133(2) is not applicable, that the proceedings will be resumed with the applicant for or proprietor of the patent as from the date on which this communication is notified.

A copy of the communication will be forwarded to the other parties.

#### 1.5 Resumption of time limits

*Rule 142(4)*

The time limits, other than the time limit for making a request for examination and the time limit for paying the renewal fees, in force at the date of interruption of the proceedings, begin again as from the day on which the proceedings are resumed. If such date is less than two months before the end of the period within which the request for examination must be filed, such a request may be filed up to the end of two months after such date.

#### 2. Stay of proceedings under Rule 14 due to pending national entitlement proceedings

*Rule 14(1)*

If a third party provides evidence that he has instituted proceedings against the applicant seeking a decision within the meaning of Art. 61(1), the proceedings for grant are stayed unless the third party communicates to the EPO in writing his consent to the continuation of

proceedings. This consent is irrevocable. For further details see A-IV, 2.2 and sub-sections, and D-VII, 4.1.

### **3. Stay of proceedings when a referral to the Enlarged Board of Appeal is pending**

Where a referral to the Enlarged Board of Appeal is pending and the outcome of examination or opposition proceedings depends entirely on the answer to the questions referred to the Enlarged Board of Appeal, the proceedings may be stayed by the Examining or Opposition Division on its own initiative or on request of a party or the parties. The party/ies will be informed of the stay of proceedings as well as of the continuation of the proceedings after a stay. During the stay of proceedings, a PACE request will have no effect. After their resumption, proceedings may (again) be accelerated (E-VII, 3.2). Where the proceedings are not stayed, they will be decided according to existing practice.

A stay of proceedings due to dependency on a referral to the Enlarged Board of Appeal is to be distinguished from a stay of proceedings pursuant to Rule 14 (see E-VI, 2).



## Chapter VII – Time limits, loss of rights, further and accelerated processing and re-establishment of rights

### 1. Time limits and loss of rights resulting from failure to respond within a time limit

#### 1.1 Determination of time limits

The EPC imposes time limits upon parties to proceedings.

*Art. 120*

Some of these are fixed by the articles of the EPC, e.g. Art. 87(1) (priority period) and Art. 99(1) (opposition). Others are fixed in the Implementing Regulations, e.g. in Rule 30(3) (payment of late-furnishing fee), Rule 38 (payment of filing and search fee), Rule 39(1) (payment of designation fees), Rule 58 (correction of deficiencies in application documents), Rule 70(1) (request for examination), Rule 71(3) (filing translations of the claims and payment of fees for grant and publishing) and Rule 112(2) (applying for a decision after notification of loss of rights).

Others take the form of a stipulated range, the precise period within this range being at the EPO's discretion.

In other cases, e.g. those dealt with in Rule 3(3) (filing translation of documentary evidence), or Rule 70(2) (invitation to the applicant to indicate whether he desires to proceed further with the European patent application), a period, but not its duration, is provided for in the EPC. The duration must be determined by the EPO in accordance with Rule 132 (see E-VII, 1.2).

#### 1.2 Duration of the time limits to be determined by the EPO on the basis of EPC provisions

The length of such periods should be based, in principle, on the amount of work which is likely to be required to perform the operation in question. However, in order to facilitate the work of parties and the EPO it has been decided, as a general rule, to adopt a uniform practice with respect to time limits. This practice is at present as follows:

- (i) if deficiencies to be corrected are merely formal or merely of a minor character; if simple acts only are requested, e.g. under Rule 83 the subsequent filing of documents referred to by a party; or if observations are required on amendments which are merely of a minor character – two months;
- (ii) communications from an Examining or Opposition Division raising matters of substance – four months.



Where a communication according to Art. 94(3) in examination is accompanied by a request for a translation of the priority (Rule 53(3)), the period set for reply to that communication and for providing the translation is the same and is at least four months, regardless of the severity of the objections raised in the communication according to Art. 94(3) (see also A-III, 6.8.2).

*Rule 70(2)*

A longer time limit of up to six months should be set only in the exceptional cases where it is clear that in the circumstances a four-month time limit cannot be adhered to. Each case must be judged on its individual merits and it is difficult to give general guidance, but a six-month time limit might be justified if for example the subject-matter of the application or patent or the objections raised are exceptionally complicated. Note that in this case an extension of the time limit (i.e. beyond six months) will be allowed only in exceptional cases (E-VII, 1.6). Where the applicant is invited to submit the indication provided for in Rule 70(2), a six-month time limit running from the publication of the search report is appropriate.

### **1.3 Time limits which may be freely determined**

Time limits for operations in respect of which the setting of a time limit is not explicitly provided for in the EPC are not subject to the restrictions as to the duration of time limits laid down in Rule 132. They may be fixed by the EPO at its own discretion.

### **1.4 Calculation of time limits**

*Rule 131*  
*Rule 126*  
*Rule 134*

Although Rule 131 allows other possibilities, any period fixed by the EPO will usually be specified in full months which will be calculated from the receipt of the communication by the person to whom it is addressed (see Rule 126(2)). Rule 131 gives precise details for the determination of the day of expiry of the period, whilst Rule 134 contains provisions covering certain contingencies, e.g. that the EPO is not open on the day on which a time limit expires, or that there is a general disruption in the postal facilities between the EPO and a Contracting State.

*Rule 142*

When proceedings have been interrupted because of the death of the applicant or proprietor or for any of the other reasons specified in Rule 142, time limits are subject to the provisions of Rule 142(4). The time limits for the payment of the examination fee and the renewal fees are suspended (see J 7/83).

### **1.5 Effect of change in priority date**

*Art. 88(2)*

Certain time limits run from the date of priority, or in the case of multiple priorities, from the earliest date of priority. Where this date no longer applies (e.g. the right of priority is lost in accordance with the provisions of Art. 90(5)), any such time limits become determinable from the amended date of priority. This does not restore any loss of rights resulting from a time limit having already expired before the loss of priority date. Part A of the Guidelines deals with the procedure to be followed (see A-III, 6.9 to 6.11).

## 1.6 Extension of a time limit

✚ Apart from the automatic extension of time limits under Rule 134 (see E-VII, 1.4) and cases in respect of which the EPC specifies a fixed period which may not be extended, the duration of time limits may be extended, but the request must be submitted in writing before expiry of the period that has been set. The extended period is to be calculated from the start of the original period. No written confirmation is required for requests for extension of time limits filed by fax. For any communication raising a matter of substance, a request for extension, even if filed without reasons, should normally be allowed if the total period set does not thereby exceed six months. A short time limit for correcting a mere formal or minor deficiency should be extended under the same circumstances by two months. However, a request for a longer extension, especially if the total period set exceeds six months, should be allowed only exceptionally, when the reasons given are sufficient to show convincingly that a reply in the period previously laid down will not be possible. Such exceptional circumstances might be e.g. the fact that a representative or client is so seriously ill that he cannot deal with the case in time; or the need to perform extensive biological experiments or tests. On the other hand, foreseeable or avoidable circumstances (e.g. leave, pressure of other work) should not be accepted as a sufficiently exceptional circumstance (see Notice of the Vice-President of Directorate-General 2 of the EPO, OJ EPO 1989, 180).

*Rule 132*

In opposition proceedings, the time limit for replying to a communication under Art. 101(1) and Rule 79 or 81(2) and (3) can be extended. All parties to the proceedings can request an extension, irrespective of whether they were invited in the communication to reply. The extension granted to one of the parties automatically applies to all other parties. However, when a request for accelerated processing is on file, requests to extend time limits over and above the normal four-month period can be granted only in exceptional, duly substantiated cases (see OJ EPO 2001, 148).

If the request for an extension is granted, the party should be informed of the new time limit. Otherwise, he should be told that the relevant sanction has taken effect or will take effect. The failure of a party to reply to a communication from the Opposition Division within the period set does not lead directly to any legal consequence. However, the opposition proceedings will proceed to the next stage, and this could be a decision under Art. 101(2) or (3).

In examination, failure to respond to a communication according to Art. 94(3) results in deemed withdrawal of the application (see E-VII, 1.8 and 1.9.2).

If the request for extension of a time limit filed in good time has been rejected and the applicant considers this unjust, he can only overcome the ensuing loss of rights by requesting further processing under Art. 121(1) and Rule 135(1). At the same time, he may request

*Art. 106(2)*

reimbursement of the fee for further processing. A decision rejecting the request for reimbursement is open to appeal, either together with the final decision or separately, as the case may be (see J 37/89).

### **1.7 Late receipt of documents**

#### *Rule 133(1)*

The fiction that a time limit has been observed is created provided a document received late was posted or delivered to one of the delivery services recognised by the President of the EPO (Chronopost, DHL, Federal Express, flexpress, TNT, SkyNet and UPS) at least five days before expiry of the time limit and was received no later than three months after expiry of the time limit (see Decision of the President of the EPO dated 14 July 2007, Special edition No. 3, OJ EPO 2007, I.1). Rule 133 applies to all time limits to be observed vis-à-vis the Office and/or the national authorities, including the priority period laid down in Art. 87(1). The document must have been sent as a registered letter or in a form of consignment corresponding to registration and, if posted outside Europe, by airmail. Within the meaning of Rule 133, a document is deemed to have been posted or delivered to a delivery service within Europe if it was despatched in one of the states belonging to the European Conference of Postal and Telecommunications Administrations (CEPT) (in addition to the EPC Contracting States these are the states listed below) or in a state which is generally understood to be part of Europe. At the request of the EPO, confirmation of registration by the post office or of receipt by the delivery service must be provided as evidence that the document was posted in due time. Despite this legal fiction that the time limit has been observed, the filing date of the document remains the day on which it was actually received.

The following non-Contracting States belong to the CEPT (updated 1 November 2012):

Andorra, Azerbaijan, Belarus, Bosnia and Herzegovina, Georgia, Moldova, Montenegro, Russian Federation, Ukraine and Vatican.

### **1.8 Failure to respond within a time limit**

If a party has not acted within a time limit, various sanctions may be applied depending on the circumstances. For instance, under Art. 90(2) and Rule 55 the application will not be proceeded with; under Art. 90(5) the application will be refused or a right of priority lost; under Rule 5 a document may be deemed not to have been received. If the request for examination has not been filed in time, the application is deemed to be withdrawn (Art. 94(2)), and this sanction may also apply in those cases where the applicant fails to meet a time limit set by the EPO (e.g. the time limit for replying to an invitation to amend under Art. 94(3)).

If a particular time limit is not complied with and, in contrast to cases where mandatory legal sanctions are laid down (e.g. revocation of the European patent if the publishing fee is not paid in due time (Rule 82(3)), no specific legal sanction is laid down in the EPC,



submissions and requests from the parties made after expiry of the time limit but before a decision is handed over to the EPO's internal postal service for transmittal to the parties are to be regarded in the rest of the proceedings as if they had been received in time (see G 12/91); any facts or evidence are, however, to be treated as not filed in due time (Art. 114(2), see also E-V, 1.2).

## **1.9 Loss of rights**

### **1.9.1 Cases of loss of rights**

If a party to the proceedings or a third party fails to comply with a time limit laid down in the EPC or fixed by the EPO, this will result in a loss of rights in certain cases specified in the EPC, without any decision concerning the refusal of the European patent application or the grant, revocation or maintenance of the European patent, or the taking of evidence.

*Rule 112*

### **1.9.2 Noting and communication of loss of rights**

If there has been a loss of any right as described in E-VII, 1.9.1, a formalities officer will note such loss of rights and communicate this to the person concerned. The communication will be notified to the person concerned as a matter of course (see also D-IV, 1.4.1).

*Art. 119*  
*Rule 112(1)*

### **1.9.3 Decision on loss of rights**

If the person concerned considers that the finding of the EPO is inaccurate, he may, within two months after notification of the communication, apply for a decision on the matter by the EPO.

*Rule 112(2)*

The competent department of the EPO will give such a decision only if it does not share the opinion of the person requesting it; otherwise it will inform the person requesting the decision and then continue with the proceedings. Since such decisions are subject to appeal, the reasons on which they are based must be stated. Only the person affected by the loss of rights noted will be party to the proceedings.

The request under Rule 112(2) for a review of the accuracy of the communication under Rule 112(1) exists in parallel to the legal remedies against the loss of rights. If the applicant fails to observe the time limit for requesting a decision under Rule 112(2), he may still apply for re-establishment of rights under Art. 122(1) and Rule 136(1) in respect of that time limit.

## **2. Further processing and re-establishment of rights**

### **2.1 Request for further processing**

If the European patent application is to be refused or is refused or deemed to be withdrawn following failure to reply within a time limit vis-à-vis the European Patent Office, the application is allowed to proceed if the applicant makes a request for further processing of the application. Further processing must be requested by payment of the prescribed fee within two months of the communication concerning

*Art. 121(1) and (2)*  
*Rule 135(1) and (3)*

either the failure to observe a time limit or a loss of rights. The omitted act must be completed within the period for making the request. The request is not deemed to have been filed until this fee has been paid. The department competent to decide on the omitted act also decides on the request for further processing.

A mere request for oral proceedings is not to be seen as completion of the omitted act and therefore cannot lead to further processing being granted (B-XI, 8).

*Rule 135(2)*

As a general rule, further processing is the legal remedy for failure to observe a time limit during proceedings before grant, even where the consequence is a partial loss of rights (e.g. loss of priority right). However, the possibility of requesting further processing is ruled out for the periods referred to in Art. 121(4) and Rules 6(1), 16(1)(a), 31(2), 36(2), 40(3), 51(2) to (5), 52(2) and (3), 55, 56, 58, 59, 62a, 63, 64, 112(2) and 164(1) and (2).



## **2.2 Re-establishment of rights**

### **2.2.1 General remarks**

*Art. 122(1)*

An applicant for or proprietor of a European patent who, despite taking all due care required by the circumstances, was unable to observe a time limit vis-à-vis the European Patent Office not specifically excluded by Art. 122(4) and Rule 136(3) may apply to have his rights re-established. According to Art. 122(4) and Rule 136(3), re-establishment of rights is ruled out in respect of all periods for which further processing is available and in respect of the period for requesting re-establishment of rights. Re-establishment applies to the time limit under Rule 135(1) for requesting further processing and also to the time limits which are excluded from further processing according to Art. 121(4) and Rule 135(2). This means that, where further processing applies to a time limit, re-establishment cannot be requested for failure to observe that time limit. However, if further processing is available, but the applicant fails to request it in time, re-establishment of rights according to Art. 122 is available for the time limit for requesting further processing. Moreover, re-establishment of rights is possible where an applicant fails to file his application within the priority period of Art. 87(1). The conditions governing this application are fully set out in Art. 122(1) to (6) and Rule 136(1) to (4). The provisions of Art. 122 and Rule 136 might be invoked if e.g. the applicant's working documents have been destroyed by fire and he has been obliged to prepare fresh ones; or if a specialist agency sent him the wrong set of drawings relating to a priority document, and the error was not immediately apparent. In all instances it is necessary for the applicant or proprietor or representative, as the case may be, to supply evidence that he had exercised all due care required by the circumstances and that the delay was caused by unforeseeable factors. Errors of law, however, do not constitute grounds for re-establishment (see e.g. D 6/82, J 31/89 and J 2/02).

Failure by an applicant to meet the time limit for filing the notice of appeal (Art. 108) cannot be remedied by further processing (Art. 121(4)); only re-establishment is available (Rule 136(3)).

### 2.2.2 Extension of re-establishment of rights to opponents

Re-establishment of opponents in respect of the time limit for filing the appeal itself is excluded under Art. 122(1) (see T 210/89). However, an opponent who has filed an appeal can request re-establishment of rights in respect of the time limit for submitting the grounds for appeal (see G 1/86).

### 2.2.3 Relevant time limits

"Time limit" is taken to mean a specific period of time within which an act vis-à-vis the EPO has to be completed. A time limit is therefore not a date, i.e. an appointed day. Accordingly, no provision may be made for re-establishment of rights in the event of failure to be present on the date appointed for oral proceedings.

*Art. 122(1)*

The following are examples of cases where re-establishment of rights may be possible in the event of failure to comply with a time limit. They concern the time limits for:

*Rule 82(2) and (3)*

*Rule 88(3)*

*Art. 108*

*Art. 112a(4)*

*Art. 87(1)*

- the payment of the fee for the publishing of the new specification of the European patent;
- the filing of the translation of any amended claims in opposition proceedings;
- filing the request for a decision by the Opposition Division on the awarding of costs;
- appeals filed by applicants or patent proprietors (see E-X, 6);
- filing a request for review by the Enlarged Board of Appeal; and
- claiming priority of an earlier first application according to Art. 87(1) (see A-III, 6.6).

### 2.2.4 Time limits not covered

Re-establishment of rights is expressly excluded as regards the time limit for requesting re-establishment of rights (see E-VII, 2.2.1) and the time limits for which further processing is available (Art. 121). Furthermore, re-establishment of rights will not be permitted in cases of failure to comply with time limits which do not have the direct consequence of causing the refusal of the European patent application or of a request, or the deeming of the European patent application to have been withdrawn, or the revocation of the European patent, or the loss of any other right or means of redress. For example, there can be no re-establishment of rights as regards the time limits for submission by the patent proprietor in opposition proceedings of his observations on the written statements of the other

*Art. 122(4)*

*Rule 136(3)*

parties to the proceedings or on communications from the Opposition Division.

### **2.2.5 Request for re-establishment of rights**

*Rule 136(1)*

The request for re-establishment of rights must be filed in writing within two months from the removal of the cause of non-compliance with the time limit. The omitted act must be completed within this period. As a general rule, the request is admissible within the year immediately following the expiry of the unobserved time limit. However, the time limit for requesting re-establishment of rights for the priority period or for filing a petition for review by the Enlarged Board of Appeal constitutes an exception to this general rule: in these cases, the request must be filed within two months of expiry of the relevant period laid down in Art. 87(1) and 112a(4).

*Rule 136(2)*

The request must state the grounds on which it is based, and must set out the facts on which it relies. It is not deemed to be filed until after the fee for the re-establishment of rights has been paid in the amount laid down in the Rules relating to Fees under the EPC.

### **2.2.6 Special considerations when there is more than one party**

If, for instance in opposition proceedings, the proprietor of the patent files a request for re-establishment of rights, the opponents and any third parties must be informed of the request and the subsequent decision if this involves the re-establishment of rights as regards a time limit connected with the opposition procedure. The opponents are party to the re-establishment proceedings (see T 552/02 and T 1561/05).

### **2.2.7 Decision on re-establishment of rights**

*Rule 136(4)*

The department competent to decide on the omitted act decides upon the request for re-establishment of rights. The grounds for the decision need only be stated if the request is disallowed, except in opposition proceedings, as opponents are party to the re-establishment proceedings (see E-VII, 2.2.6).

The department which took the contested decision will have to consider re-establishment of rights in respect of an unobserved time limit for appeal when the conditions for granting interlocutory revision are fulfilled (see E-X, 7). It can, however, only decide to allow re-establishment if it can do so within the three-month time limit of Art. 109(2) and the conditions for re-establishment (see E-VII, 2.2.1 to 2.2.5) are fulfilled. In all other cases, the appeal, together with the application for the re-establishment of rights, must be submitted to the competent Board of Appeal.

## **3. Accelerated prosecution of European patent applications**

Applicants requiring faster search or examination can ask to have their applications processed under the programme for accelerated prosecution of European patent applications (PACE) (see the Notice from the EPO dated 4 May 2010, OJ EPO 2010, 352).

### 3.1 Accelerated search

An accelerated search (within six months of the date of filing) will be carried out without the need for a separate request for European patent applications claiming no priority (first filings). However, an application will be considered a "first filing" only if the applicant has indicated on filing his intention not to file a declaration of priority at a later stage of the proceedings.

For second filings (European patent applications claiming priority), accelerated search can be requested on filing. In these cases the Office will make every effort to issue the search report as soon as possible, provided that this is practically feasible.

In both cases, however, an accelerated search will be possible only if the application documents on filing are complete enough for the search to be performed. In particular, the description, the claims, any translation required and (if applicable) the drawings and sequence listings conforming to Rule 30(1) must be supplied on filing. Prosecution under PACE will be not possible for applications filed by reference to a previous application under Rule 40(1)(c) and (2) and for applications in which missing parts of the description and/or missing drawings have been filed under Rule 56.

### 3.2 Accelerated examination

Accelerated examination may, in principle, be requested in writing at any time. However, to be as effective as possible, it should preferably be requested:

- when filing the European patent application, provided that examination is bindingly requested at the same time (see C-VI, 3), or
- after receipt of the extended search report and together with the applicant's response to the search opinion under Rule 62.

When accelerated examination is requested, the Office makes every effort to issue the first examination communication within three months of receipt by the Examining Division of the application, the applicant's response under Rule 70a or the request for accelerated examination (whichever is later).

For Euro-PCT applications too, accelerated examination may, in principle, be requested at any time. However, to be as effective as possible, it should preferably be requested:

- on entry into the European phase before the EPO, or
- together with any response to the WO-ISA, IPER or SISR required under Rule 161(1).

If requested on entry into the European phase, accelerated prosecution covers formalities examination, the supplementary European search report and/or substantive examination, as applicable.

Since a communication under Rule 161(1) or (2) is sent for a Euro-PCT application (E-VIII, 3), the processing of a Euro-PCT application will only start after the expiry of the six-month period even if an acceleration has been requested under the PACE programme. In order to start with the supplementary European search or examination directly, the applicant, on entry into the European phase, has to explicitly waive the right to the communication pursuant to Rule 161(1) or (2) and 162, pay any claims fees due and, where required, submit a response under Rule 161(1) (see the Notice from the EPO dated 5 April 2011, OJ EPO 2011, 354).

#### **4. Accelerated processing of oppositions**

In cases where an infringement action in respect of a European patent is pending before a national court of a Contracting State, a party to the opposition proceedings may request accelerated processing. The request may be filed at any time. It must be filed in written reasoned form. In addition, the EPO will also accelerate the processing of the opposition if it is informed by the national court or competent authority of a Contracting State that infringement actions are pending (see the Notice of the EPO dated 17 March 2008, OJ EPO 2008, 221).

#### **5. Accelerated processing before the Boards of Appeal**

Parties with a legitimate interest may ask the Boards of Appeal to deal with their appeals rapidly. The Boards can speed up an appeal as far as the procedural regulations allow. Requests for accelerated processing must be submitted to the competent Board either at the beginning of or during proceedings. They should contain reasons for the urgency together with relevant documents. This option is also available to the courts and competent authorities of the Contracting States (see the Notice from the Vice-President Directorate-General 3 dated 17 March 2008, OJ EPO 2008, 220).

#### **6. Renunciation of rights**

##### **6.1 Withdrawal of application or designation**

*Rule 15*

The applicant may withdraw his application at any time up to the grant of the European patent (see also C-V, 11), provided that no third party has proven to the EPO that he has initiated proceedings concerning entitlement to the application pursuant to Rule 15.

*Art. 79(3)*

*Rule 39(2) and (3)*

The same also applies to the withdrawal of a designation (see also A-III, 11.3.8). If all designations are withdrawn, the application is deemed to be withdrawn.

Withdrawal of the application in due time before the eighteen-month publication has the advantage that the contents of the application do not become known to the public (see A-VI, 1.2). If, furthermore, no rights have been left outstanding and the application has not served as a basis for claiming a right of priority, a subsequent application for the same invention can be considered as the first application for the purposes of determining priority (see F-VI, 1.4.1). If the examination fee has been paid, it will be refunded in full or in part (see A-VI, 2.5).

*Art. 87(4)*

## **6.2 Withdrawal of priority claim**

The priority claim may also be withdrawn (see F-VI, 3.5). If this is done before the technical preparations for publication of the application are completed, the publication will be deferred until eighteen months after the date of filing of the European application (see A-VI, 1.1).

## **6.3 Statement of withdrawal**

Any statement of withdrawal must be unqualified and unambiguous. It may, however, be conditional upon, e.g. avoidance of publication or refund of the examination fee.

If such a statement of withdrawal is made orally during oral proceedings, then either a handwritten signed confirmation should be submitted during the proceedings or the Division should confirm the withdrawal in the minutes and read out the corresponding passage for confirmation in the oral proceedings. The withdrawal has effect from the date of the oral proceedings.

Where a patent application has been refused by the Examining Division, proceedings are still pending until the expiry of the period for filing an appeal. On the day after, proceedings are no longer pending if no appeal is filed. Therefore, an application which is refused during oral proceedings can still be withdrawn in this period.

## **6.4 Surrender of patent**

A patent may not be surrendered in opposition proceedings by the proprietor filing a declaration of surrender with the EPO. Such a surrender must be declared before the competent authorities in the designated states in question (see D-VII, 5.1). Nevertheless, if a proprietor unambiguously declares to the EPO the surrender (or abandonment or renunciation) of the patent, this is deemed equivalent to a request that the patent be revoked (see also D-VIII, 1.2.5).

*Rule 84(1)*





## Chapter VIII – Applications under the Patent Cooperation Treaty (PCT)

### 1. General remarks

The EPO may be a "designated Office" or an "elected Office" for an international application filed under the Patent Cooperation Treaty (PCT) designating "EP" (Euro-PCT application). Such application is thereby deemed to be a European application (Euro-PCT application) for the purposes of the EPC. However, in the case of Euro-PCT applications, the provisions of the PCT apply in addition to those of the EPC, and where there is conflict between them, e.g. in the case of certain time limits, the provisions of the PCT prevail. According to Art. 153(1)(a), the EPO is a designated Office for Contracting States to the EPC in respect of which the PCT has entered into force, which are designated in the international application and for which the applicant wishes to obtain a European patent. If the applicant has elected a designated State, the EPO is an elected Office (Art. 153(1)(b), for details see E-VIII, 2.1.1).

*Art. 153(1)(a) and (b)*

*Art. 153(2)*

*Art. 150(2)*

In addition to being a designated Office, the EPO may act as a receiving Office under the PCT within the terms set out in Art. 151. Furthermore, it may also act as an International Searching Authority (ISA), as an International Preliminary Examining Authority (IPEA) under the terms of Art. 152 and/or as a Supplementary International Searching Authority (SISA) under the PCT. There are thus the following possibilities for a European application filed under the provisions of the PCT:

*Art. 151*

*Art. 152*

*Rule 157*

*Rule 158*

- (i) the filing of the application and the international search take place at an office or offices other than the EPO (e.g. the Japan Patent Office). The EPO is a designated Office;
- (ii) the application is filed at another office (e.g. the United Kingdom Patent Office) but the EPO performs the international search. The EPO acts as International Searching Authority and is a designated Office;
- (iii) the application is filed at the EPO, which also performs the international search. The EPO acts as receiving Office, International Searching Authority and designated Office;
- (iv) in addition to the cases mentioned under (i) - (iii), the applicant files a demand for international preliminary examination. The EPO is the "elected Office";

- (v) the EPO is the International Preliminary Examining Authority. It may carry out this function without being the receiving Office, a designated Office or an elected Office. The EPO can, however, only act as an IPEA if the international search was carried out by the EPO, the Austrian, Spanish, Swedish or Finnish Patent Office or the Nordic Patent Institute;
- (vi) if the international search has been carried out by an office other than the EPO, the applicant may still request the EPO to perform a supplementary international search (SIS) in its capacity as SISA.

In case (i), the European application will be accompanied by an international search report drawn up by another office. In cases (ii) and (iii), the international search report and the "written opinion of the International Searching Authority" (WO-ISA) (Rule 43*bis* PCT) will be prepared by the Search Division of the EPO. In case (iv), the international search report and the international preliminary examination report may be drawn up by the EPO or by another International Searching Authority and International Preliminary Examining Authority.

For further details, in particular as to deadlines and procedural steps before the EPO as RO, ISA, IPEA or SISA, see the latest version of the Guide for applicants: "How to get a European patent, Part 2: PCT procedure before the EPO – Euro-PCT".

## 2. EPO as designated or elected Office

### 2.1 General

#### 2.1.1 Introduction

Art. 153(2)

Pursuant to Art. 153(2), an international application for which the EPO is a designated or elected Office is deemed to be a European patent application. For information about time limits and procedural steps before the EPO as a designated or an elected Office under the PCT, see the Guide for applicants "How to get a European patent, Part 2: PCT procedure before the EPO – Euro-PCT".

In order to initiate the European phase, the requirements for entry into the European phase according to Rule 159 must be complied with (see E-VIII, 2.1.2 and 2.1.3). For entry into the European phase, applicants are strongly recommended to use the most recent edition of Form 1200 obtainable from the EPO free of charge in printed form, as editable electronic document from the EPO website or as part of the Online Filing software.

This Chapter deals with the **differences** from the practice set out in Part A of the Guidelines when dealing with such international applications as a designated or elected Office. First, however, some specific aspects of the processing of international applications in the

procedure before the EPO as designated/elected Office are set out in E-VIII, 2.2, 2.3 and 2.4 below.

### **2.1.2 Initial processing and formal examination; copy of the international application; translation**

The initial processing and formal examination of international applications in the international phase are carried out by PCT authorities under the PCT. Unless there is a specific request from the applicant, the EPO acting as a designated or elected Office may not process or examine an international application prior to the expiry of 31 months from the date of filing of the application or, if priority has been claimed, from the earliest priority date (31-month time limit), (see E-VIII, 2.8 and 2.5.2). Since the EPO has not exercised the waiver referred to in Art. 20(1)(a) PCT, a copy of the international application will be furnished by the International Bureau. The EPO does not require the applicant to furnish a copy of the international application under Art. 22 or 39 PCT, even if the International Bureau has not yet communicated a copy under Art. 20 PCT at the time the application enters the European phase (see PCT Gazette 14/1986, 2367).

*Art. 23 PCT*  
*Art. 40 PCT*  
*Rule 49.1(a-bis) PCT*  
*Art. 24(1)(iii) PCT*  
*Rule 159(1)*  
*Rule 160*  
*Art. 121*  
*Art. 2, No. 12, RFees*

Where the language of the international application is not an official language of the EPO, the applicant is required, in accordance with Art. 22 or 39 PCT and Rule 159(1)(a), to furnish a translation within a period of 31 months from the date of filing or, if priority has been claimed, from the earliest priority date (31-month time limit). The application is deemed to be withdrawn if the translation is not furnished within that period (Rule 160(1)). If the EPO finds that the application is deemed to be withdrawn for this reason, it communicates this to the applicant (Rule 160(3)). Rule 112(2) applies *mutatis mutandis*. The loss of rights is deemed not to have occurred if, within two months as from notification of the communication, the translation and a valid request for further processing (including the payment of the requisite fee) are filed (Art. 121 and Rule 135(1)).

Where an international application was filed and published in the international phase in an official language of the EPO, it is not possible to change the language of the proceedings on entry into the European phase by filing a translation of that application into either of the other two official languages of the EPO (see G 4/08). In such cases, the language of the proceedings within the meaning of Art. 14(3) remains the language in which the application was published by WIPO's International Bureau and cannot be changed.

### **2.1.3 Filing fee, designation fee, request for examination, search fee and claims fees**

Under Rule 159(1)(c), the applicant must pay the filing fee, including any additional fee for pages in excess of thirty-five (see A-III, 13.2), within a period of 31 months from the date of filing or, if priority has been claimed, from the earliest priority date. Further, under Rule 159(1)(d), he must pay the designation fee within this period, if

*Rule 159(1)*  
*Rule 160*  
*Art. 2, No. 12, RFees*

the time limit specified in Rule 39(1) has expired earlier. Under Rule 159(1)(f), the request for examination must also be filed within this period, if the time limit specified in Rule 70(1) has expired earlier. Where a supplementary European search report needs to be drawn up, a search fee must also be paid to the EPO within this period. Failure to pay in due time the filing fee, the additional fee, the search fee, the designation fee or the examination fee, or to file the request for examination, means that the application is deemed to be withdrawn.

If the EPO finds that the application is deemed to be withdrawn for this reason, it communicates this to the applicant (Rule 160(2)).

The communication under Rule 160(2) and the communication according to Rule 112(1) are sent together in one and the same communication. In response to this notification of a loss of rights, the applicant can request further processing. Any loss of rights ensues on expiry of the normal period (see G 4/98).

#### *Rule 162*

If applicable, the claims fees under Rule 162 must also be paid within the 31-month time limit referred to above. If they are not, they may still be validly paid within a non-extendable period of grace of six months of notification of a communication pointing out the failure to pay, which is combined with the communication under Rule 161. If amended claims are filed during this grace period, they form the basis for calculating the number of claims fees due. Where a claims fee has not been paid in time, the claim concerned is deemed to be abandoned. Features of a claim deemed to have been abandoned pursuant to Rule 162(4) and which are not otherwise to be found in the description or drawings cannot subsequently be reintroduced into the application and, in particular, into the claims.

#### **2.1.4 PCT vs. EPC provisions**

#### *Art. 150(2)*

In proceedings before the EPO relating to international applications, the provisions of the PCT are applied, supplemented by the provisions of the EPC. In case of conflict, the provisions of the PCT prevail. The EPO cannot require compliance with requirements relating to form or contents of the international application different from or additional to those which are provided for in the PCT. As a result of the overriding PCT provisions and the requirements of Part X of the EPC, i.e. Art. 150 to 153, relating to international applications pursuant to the PCT, the practice set out in the earlier Chapters of this Part A of the Guidelines does not necessarily hold good for international applications. In particular, where the PCT international publication was in an official EPO language, it is not necessary for the Receiving Section to subject the copy of the application furnished to the EPO to a formalities examination except to the extent indicated later. On the other hand, where it is necessary to furnish a translation of the international application, the Receiving Section must carry out for that translation a more extensive formalities examination.

Hereafter, the formalities examination of an international application upon entry into the European phase is considered, **insofar as it differs** from that applicable to European direct applications, by reference to the provisions of appropriate sections of Part A.

## **2.2 Provisions of Chapter A-II ("Filing of applications and examination on filing")**

The provisions of A-II, 1 ("Where and how applications may be filed") do not apply to international applications, except where explicit reference is made to international applications, including Euro-PCT applications.

The PCT requirements corresponding to those of A-II, 2 ("Persons entitled to file an application") are more restrictive, as in general the applicant must be a resident or national of a PCT Contracting State and therefore no supplementary examination should be necessary.

The provisions of A-II, 3 ("Procedure on filing") do not apply.

The provisions for late filing of missing parts completely contained in the priority document (Rule 56) exist also under the PCT (Rule 20.5 to 20.8 PCT).

The date of filing (see A-II, 4 ("Examination on filing")) of a Euro-PCT application is that accorded under the PCT by the PCT authority which acted as the receiving Office. The formalities examination upon entry into the European phase encompasses all checks required to verify that the requirements of Rules 159 and 163 have been met.

If the application is not deemed to be withdrawn, a copy of the application is referred to the Search Division for drawing up any supplementary European search report, if necessary (see E-VIII, 3.1).

## **2.3 Provisions of Chapter A-III ("Examination of formal requirements")**

### **2.3.1 Representation**

The provisions of A-III, 2 ("Representation") apply to international applications whether furnished in an official language or in translation. An agent having a right to practise before the PCT International Authorities is not necessarily authorised to act before the EPO (see Art. 27(7) PCT). For the representation of applicants before the EPO as designated or elected Office see the latest version of the Guide for Applicants "How to get a European patent, Part 2: PCT procedure before the EPO – Euro-PCT".

*Rule 163(4) to (6)*

If there is more than one applicant and the following information was not provided for one or more of those applicants in the International phase and is still missing at the expiry of the 31-month time limit under Rule 159(1):

- (i) address
- (ii) nationality
- (iii) State of residence or principal place of business

the EPO will invite the applicant to furnish these indications within two months. Failure to do so will lead to refusal of the application. The same applies if the requirements for representation are not met at the end of the 31-month time limit, with the same consequence for failure to correct the deficiency in time. If the applicant fails to reply in time to the above-mentioned invitation, he may request further processing.

**2.3.2 Physical requirements**

Particularly where the PCT international publication was in an official EPO language, the formalities examination of the physical requirements of the copy of the application furnished to the EPO by the International Bureau is of a very limited nature, since compliance of an international application with the PCT requirements as to form and content is, as a rule, ascertained during the international phase.

Since the translation filed under Rule 159(1)(a) is filed for the procedure before the EPO as designated or elected Office, the translation must comply with the physical requirements as set out in A-III, 3 ("Physical requirements"). The requirements are in general identical with the corresponding requirements of the PCT.

**2.3.3 Request for grant**

The PCT request corresponds in general to the EPO Request for Grant form (Form 1001) and provides for the entry of the information listed in Rule 41(2), with the exception of the items referred to in sub-paragraphs (e) and (f) thereof.

**2.3.4 Designation of inventor***Rule 163(1)*

The requirement, as set out in A-III, 5 ("Designation of inventor"), that the designation of inventor is filed in a separate document where the applicant is not the inventor or the sole inventor has to be complied with irrespective of the language of the international application, unless the inventor has already been named in the PCT request. Where the inventor has been named in the PCT request, he cannot waive his right to be mentioned in the published application. If the inventor has not been named in the international application at the expiry of the period of 31 months from the date of filing, or, in the case of priority, from the earliest date of priority claimed (31-month time limit), the EPO invites the applicant to file the designation of inventor within a period of two months. Failure to rectify this

deficiency in time, leads to refusal of the application according to Rule 163(6). The applicant will be notified of this decision according to Rule 111. He may request further processing.

### 2.3.5 Claim to priority

The claim to priority (see A-III, 6 ("Claim to priority")) for an international application refers to the date, or dates, claimed under the PCT. Normally, the copy of the previous application, referred to in A-III, 6.7, i.e. the priority document, is furnished to the EPO as designated Office by the International Bureau and not by the applicant. In accordance with Rule 17.2 PCT, the International Bureau will be requested by the EPO to furnish it with a copy as standard practice promptly, but not earlier than international publication, or, where the applicant has requested early examination (in accordance with Art. 23(2) PCT), not earlier than the date of the request. Where the applicant has complied with Rule 17.1(a) and (b) PCT, the EPO may not ask the applicant himself to furnish a copy.

*Rule 17.1 and  
17.2 PCT*

Where the file number or the copy of the previous application has not yet been submitted at the expiry of the 31-month time limit, the EPO invites the applicant to furnish the number or the copy within a specified period. However, Rule 53(2) and the Decision of the President of the EPO dated 9 August 2012, OJ EPO 2012, 492, providing an exception to the requirement that a copy of the previous application be furnished (see A-III, 6.7), also apply to international applications entering the European phase. Furthermore, as just mentioned, where the applicant has complied with Rule 17.1(a) or (b) PCT the EPO as a designated Office may not ask the applicant himself to furnish it with a copy of the priority document (Rule 17.2(a) PCT, second sentence).

*Rule 163(2)*

If the priority document is not on file, substantive examination may nevertheless be started, provided that neither intermediate documents (published in the priority period) nor Art. 54(3) documents exist which cause the patentability of the subject-matter claimed to depend on the validity of the priority right. However, no European patent may be granted until such time as the priority document is on file. In such a case, the applicant is informed that the decision to grant will not be taken as long as the priority document is missing. In such cases, however, the application may be refused without the priority document being on file, provided that the relevant prior art is neither an intermediate document nor an Art. 54(3) document, the relevance of which depends on the validity of the priority right. For more details on treatment of such cases in examination see F-VI, 3.4.

Where a translation of the previous application into one of the official languages of the EPO is required, it must be filed on request from the EPO in accordance with Rule 53(3) (see A-III, 6.8 and sub-sections and 6.10).

*Art. 88(1)  
Rule 53(3)*

The provisions for restoration of priority right (see A-III, 6.6) exist also under the PCT (Rules 26*bis*.3 and 49*ter* PCT). Under the PCT, restoration of right of priority can be made either in the international phase before the receiving Office (Rule 26*bis*.3 PCT) or upon entry into the European phase before the EPO (Rule 49*ter*.2(b)(i) PCT).

It should be noted that the EPO as both receiving Office and designated/elected Office applies the "due care" criterion in accordance with its practice under Art. 122 (Rules 26*bis*.3(a)(i) and 49*ter*.2(a)(i) PCT). As a consequence, any request for restoration of priority rights granted by a receiving Office under the "unintentional" criterion is not valid in the procedure before the EPO as designated/elected Office (Rule 49*ter*.1(b) PCT).

### **2.3.6 Title of the invention**

In relation to A-III, 7 ("Title of the invention"), the title need only meet the less demanding requirements of Rule 4.3 PCT rather than those set out in A-III, 7.1 and 7.2.

### **2.3.7 Prohibited matter**

As prohibited statements or matter may not necessarily be omitted under Art. 21(6) PCT, the application must be examined to ensure that the provisions of A-III, 8 ("Prohibited matter") are complied with. Where the EPO is informed by the International Bureau that statements or matter were omitted from the published PCT application, the Receiving Section should ensure that the corresponding material is excluded from the translation as furnished by the applicant.

### **2.3.8 Claims fee**

The time limit for paying the claims fee referred to in A-III, 9 is, as indicated in E-VIII, 2.1.3, 31 months from the date of filing or, if priority has been claimed, from the earliest priority date (31-month time limit) (Rule 162(1)).

### **2.3.9 Drawings**

The provisions of A-II, 5 and A-III, 3.2 with regard to the filing of drawings are identical with the corresponding provisions of the PCT and therefore no supplementary examination should be necessary.

### **2.3.10 Abstract**

The abstract (see A-III, 10 ("Abstract")) is included in the copy of the international application supplied to the EPO.

### **2.3.11 Designation fee**

The time limit for paying the designation fee is 31 months from the date of filing or, if priority has been claimed, from the earliest priority date (31-month time limit), if the time limit specified in Rule 39(1) has expired earlier (Rule 159(1)(d)) (see A-III, 11.2.5, for further details). If, subsequent to the receipt of the international application by the EPO and prior to the date on which processing or examination may



start, the regional designation of all Contracting States of the EPC is withdrawn, the Euro-PCT application, insofar as it is deemed to be a European application pursuant to Art. 153(2) and Art. 11(3) PCT, is deemed to be withdrawn.

For information on the requirements for extension of a Euro-PCT application to States for which an Extension Agreement with the EPO has become effective, see A-III, 12.

## 2.4 Provisions of Chapter A-IV ("Special provisions")

### 2.4.1 Divisional applications

In relation to A-IV, 1 ("European divisional applications") there is no provision in the PCT for filing divisional applications. One or more European divisional applications may be filed in respect of subject-matter contained in a pending Euro-PCT application, but not before the latter application has entered the European phase (see A-IV, 1.1), i.e. not before the time limit under Rule 159(1) (in conjunction with Art. 22(1) PCT and Art. 22(3) PCT) has expired (see G 1/09, Reasons 3.2.5), and on condition that any requirement of Art. 22(1) PCT which must be fulfilled within that time limit for the application concerned is met (see J 18/09). Furthermore, divisional applications may be filed as from the date the applicant has requested early processing in accordance with Art. 23(2) PCT (see J 18/09, Reasons 9, and E-VIII, 2.9). For the sake of completeness it is noted that the requirements of Rule 36 for filing divisionals must be complied with (see A-IV, 1). The divisional application must be filed in the language specified in Rule 36(2) (see A-IV, 1.3.3). In order to avoid that the Euro-PCT application is deemed withdrawn at the time a divisional application is filed, the respective requirements of Rule 159(1) EPC must be fulfilled within the relevant time limits (see also the Guide for applicants: "How to get a European patent, Part 2: PCT procedure before the EPO – Euro-PCT").

### 2.4.2 Sequence listings

Rules 5.2 and 13<sup>ter</sup> PCT apply to the filing of sequence listings (see A-IV, 5 ("Applications relating to nucleotide and amino acid sequences")). The EPO as International Searching Authority (see E-VIII, 3) makes use of the opportunity under Rule 13<sup>ter</sup>.1 PCT to invite the applicant where appropriate to furnish it with the prescribed sequence listing in electronic form according to WIPO Standard ST.25, paragraph 39 ff (see Art. 4 of the Decision of the President of the EPO dated 28 April 2011, OJ EPO 2011, 372, and the Notice from the EPO dated 18 October 2013, OJ EPO 2013, 542 (point II)). The furnishing of sequence listings in response to an invitation under Rule 13<sup>ter</sup>.1 PCT is subject to a late furnishing fee (see Rule 13<sup>ter</sup>.1(c) PCT). If the required sequence listing is received after the applicable time limit but before the start of the international search, it will be considered by the EPO in its capacity as ISA as if it had been received within that time limit.

**Rule 163(3)**

For Euro-PCT applications entering the regional phase before the EPO, the applicant will be invited to furnish a sequence listing in electronic form, i.e. in text format (TXT), in accordance with WIPO Standard ST.25 and pay a late furnishing fee within a period of two months, if such a sequence listing is not available to the EPO at the expiry of the 31-month time limit (see Rule 163(3) and 30(3)). The sequence listing should not be filed on paper or, in the case of electronic filing of the application, in PDF format. (see Art. 5 of the Decision of the President of the EPO dated 28 April 2011, OJ EPO 2011, 372, and the Notice from the EPO dated 18 October 2013, OJ EPO 2013, 542).

## **2.5 Provisions of Chapter A-VI ("Publication of application; request for examination and transmission of the dossier to Examining Division")**

### **2.5.1 Publication of the international application**

**Art. 153(3) and (4)  
Rule 159**

The international publication of a Euro-PCT application in an official language of the European Patent Office takes the place of publication of the European patent application and will be mentioned in the European Patent Bulletin. If the international publication of the Euro-PCT application is in another language, a translation into one of the official languages must be filed with the EPO within 31 months of the priority date (Art. 22(1) PCT and Rule 159(1)(a)). The EPO will publish the translation. Information as to what the translation must include and further details concerning the requirement to file a translation can be found in the Euro-PCT Guide ("How to get a European patent, Guide for applicants, Part 2: PCT procedure before the EPO").

**Rule 160(1)**

If the translation is not supplied, the application is to be deemed withdrawn (Art. 24(1) PCT, Rule 160(1)). Furthermore, in this case, the application which has been published under the PCT is not considered as comprised in the state of the art in accordance with Art. 54(3) (see G-IV, 5.2). However, if the EPO finds that the application is deemed to be withdrawn because the translation was not filed in due time, it must first communicate this to the applicant (Rule 160(2)). Rule 112(2) applies *mutatis mutandis*. The loss of rights is deemed not to have occurred if, within two months as from notification of the communication, the translation is supplied, a request for further processing under Art. 121 and Rule 135(1) is filed, and the fee for further processing is paid.

### **2.5.2 Request for examination**

**Art. 153(6)  
Art. 150(2)  
Rule 159(1)(f)**

The time limit under Rule 70(1) for filing the request for examination referred to in A-VI, 2 runs from the date of publication under Art. 21 PCT of the international search report. However, this time limit will not expire before the time prescribed by Rule 159(1)(f) (31-month time limit). See also E-VIII, 2.1.3.

European substantive examination must normally not begin before expiry of the 31st month from the earliest priority date (Art. 40(1) PCT). The only circumstance in which examination may begin earlier is if the applicant has expressly so requested and if any required supplementary search report is available (Art. 40(2) PCT).

### **2.5.3 Supplementary European search**

If a supplementary European search report has to be drawn up in respect of an international application which is deemed to be a European patent application, the applicant is entitled to receive the invitation provided for in Rule 70(2) (see A-VI, 2.3, 2nd paragraph, and J 8/83). A time limit of six months from the notification of this communication is set for filing the confirmation required under Rule 70(2) and for response to the search opinion accompanying the supplementary European search report (Rule 70a(2) and the Notice from the EPO dated 15 October 2009, OJ EPO 2009, 533).

*Rule 70(2)*

### **2.6 Reduction and refunds of fees in respect of international (PCT) applications**

See A-X, 9.3 and 10.2.

### **2.7 Communication to the EPO as a designated Office**

A copy of the application together with the international search report or a declaration in accordance with Art. 17(2)(a) PCT is communicated by the International Bureau to the EPO as a designated Office in accordance with Art. 20(1)(a) PCT. Furthermore, the EPO does not require the applicant to furnish a copy of the international application (Rule 49.1(a-bis) PCT). The EPO as a designated Office will then examine the application for compliance with the requirements of the EPC (see in particular E-VIII, 2.3).

*Art. 20(1)(a) PCT  
Rule 44bis.2 PCT*

The International Bureau shall communicate the International Preliminary Report on Patentability (Chapter I of the PCT) and any informal comments received from the applicant to the EPO as designated Office at 30 months from the priority date.

### **2.8 Delaying of the procedure before the EPO**

When acting as a designated Office, the EPO must not process or examine an international application before expiry of the period applicable under Art. 22 PCT (Art. 23(1) PCT). However, the EPO may, on the express request of the applicant, process or examine an international application at any time (Art. 23(2) PCT). The applicant may request the International Bureau to communicate a copy of the Written Opinion established by the International Searching Authority to the EPO as designated Office once a request under Art. 23(2) PCT is made.

*Art. 23 PCT  
Rule 44bis.2 PCT*

### **2.9 Early processing**

A request for early processing under Art. 23(2) or 40(2) PCT may be filed with the EPO at any time before expiry of the 31-month time limit (Art. 22(3) PCT and Rule 159(1)). The request does not require a

*Art. 23(2) and  
40(2) PCT*

specific wording, but the applicant must clearly express that he wishes the processing of his application before the EPO as designated/elected Office to commence early.

*Rule 159(1)*

For the request to be effective, the applicant must comply with the requirements stipulated in Rule 159(1) as if the 31-month time limit expired on the date he requests early processing, i.e.: payment of the filing fee (including any additional fee under Art. 2(1), item 1a, RFees if the application comprises more than 35 pages), filing of a translation (if a translation is required under Art. 153(4)), specification of the application documents, and payment of the search fee (where a supplementary European search report has to be drawn up under Art. 153(7)). Which further requirements stipulated in Rule 159(1) must be complied with depends on the date on which early processing is requested, since the (regular) time limits for paying the designation fee (Rule 39(1)) and the renewal fee (Rule 51(1)) and for filing the request for examination and paying the examination fee (Rule 70(1)) may not have expired on the date the request for early processing is filed. Therefore, if any of these time limits is still running on that date (or, in the case of the renewal fee, if the due date according to Rule 51(1) is later than that date), the request for early processing will be effective without the requirement(s) concerned having been complied with (Art. 153(2), Art. 11(3) PCT). If pursuant to Rule 159(1)(h) a certificate of exhibition must be filed and this requirement is not met, this will not prevent the request for early processing from being effective, but it will affect the prior art that the EPO takes into account in the European phase.

If on the date the request for early processing is filed any necessary requirement is not complied with, the request will be effective only as from the date on which all necessary requirements have been complied with.

If on the date the request for early processing is filed all necessary requirements for entry into the European phase are complied with, the request is effective and the Euro-PCT application will as from that date be processed in the same way as a Euro-PCT application which has entered the European phase by fulfilling the necessary requirements of Rule 159(1) within the 31-month time limit and without a request for early processing having been filed. On that date the international phase is thus terminated in respect of the EPO as designated/elected Office (J 18/09, Reasons 13). Moreover, since by filing an effective request for early processing the processing ban is lifted, as from that date it is no longer possible to claim the 31-month time limit under Rule 159(1). For details see the Notice from the EPO dated 21 February 2013, OJ EPO 2013, 156, as well as the Euro-PCT Guide ("How to get a European patent, Guide for applicants, Part 2, PCT procedure before the EPO") (see also E-VIII, 2.4.1, 2.5.2 and 2.8).

## 2.10 Review by the EPO as a designated Office

The EPO may decide, in accordance with Art. 25 PCT, to allow an international application deemed to be withdrawn, or not accorded a filing date, to proceed as a European application. The Examining Division is competent to take decisions in relation to these applications, and the Receiving Section transfers copies of any documents received from the International Bureau under the circumstances of Art. 25(1)(a) PCT to the Examining Division. Where it is decided that the application can proceed as a European application, the search and examination is carried out as for other applications although the application may be accorded the date it was originally filed with the PCT receiving Office and may claim the priority date, if any, of the international application.

*Rule 159(2)*

## 2.11 Inspection of files

In its capacity as a designated Office, the EPO also allows access to its files pertaining to the international phase of applications, provided that international publication has taken place. The above applies *mutatis mutandis* to the communication of information from the files.

*Art. 30(2) PCT*

In its capacity as elected Office the EPO allows access to its files (including the entire PCT Chapter II file) relating to the international phase of applications filed on or after 1 July 1998, provided international publication has taken place and, as far as the PCT Chapter II file is concerned, the IPER has been completed. The above applies *mutatis mutandis* to the communication of information from the files.

*Rule 94.3 PCT*

## 3. The communication according to Rule 161

### 3.1 Applications for which a supplementary European search report is prepared

Where the application under consideration derives from an international application for which the EPO did not act as ISA or as the authority charged with the supplementary international search (SISA), the application is subject to a supplementary European search under Art. 153(7) (see B-II, 4.3, the Decision of the Administrative Council of 28 October 2009, OJ EPO 2009, 594, the Notice from the EPO dated 24 March 2010, OJ EPO 2010, 316 and the Notice from the EPO dated 5 April 2011, OJ EPO 2011, 354), and normally an EESR is issued accordingly (see B-XI, 1 and 2). The first communication is then issued as in C-III, 4.

In such cases, promptly after entry into the European phase, the applicant is invited to amend the application within a period of six months (see the Notice from the EPO dated 29 June 2010, OJ EPO 2010, 406, and the Notice from the EPO dated 15 October 2009, OJ EPO 2009, 533). All amendments and comments filed within this period will be taken into account in drawing up the supplementary European search report and the search opinion. The supplementary European search will be based on the

*Rule 161(2)*

last set of claims filed up to expiry of this period for which any claims fee due is paid.

The applicant may, but is not required to, reply to the WO-ISA, IPER or SISR drawn up by an authority other than the EPO, normally in the form of amendments and/or comments filed with Form 1200 or in response to a communication under Rule 161(2). If the applicant does reply to the WO-ISA, IPER or SISR, the supplementary search report and the search opinion will be drawn up taking this reply into account (see B-II, 4.3 and B-XI, 2).

For proceeding directly to supplementary European search without having to wait until the six-month time limit under Rule 161(2) expires, the applicant may explicitly waive his right to a communication pursuant to Rules 161(2) and 162. No communication under Rule 161(2) or 162 is issued if, in addition to the waiver, the applicant has already paid any claims fees due (see the Notices from the EPO dated 4 May 2010, OJ EPO 2010, 352 and dated 5 April 2011, OJ EPO 2011, 354). If not, the communication will be issued and the application will be processed only after expiry of the six-month period, even if a request under the PACE programme has been filed (see E-VII, 3.2).

When preparing the first communication in examination for such cases, the examiner may have to consider the international search report (with the corresponding International Preliminary Report on Patentability (IPRP) or the International Preliminary Examination Report (IPER)), any supplementary international search report (SISR), any supplementary European search report (with the corresponding search opinion) prepared by the EPO (see B-II, 4.3) and any reply filed in response thereto (see C-II, 3.1).

### **3.2 Applications for which no supplementary European search report is prepared**

#### *Rule 161(1)*

If the EPO acted as ISA, the authority specified for the supplementary international search (SISA) and/or IPEA, a written opinion of the ISA (WO-ISA), a supplementary international search report (SISR) and/or an international preliminary examination report (IPER) will already have been transmitted to the applicant during the PCT phase. For applications where a communication according to Rule 161 has not yet been issued by 1 April 2010 and where a supplementary European search report is not prepared (see B-II, 4.3 and the Decision of the Administrative Council of 28 October 2009, OJ EPO 2009, 594), the applicant will be required to respond to the WO-ISA or SISR prepared by the EPO or, where applicable, to the IPER prepared by the EPO as IPEA. This does not apply where amendments or observations have already been filed which can be considered to be a reply (subject to certain requirements, see E-VIII, 3.3.1 and 3.3.5). The time limit for response is six months from the invitation according to Rule 161(1) and is not extendable. Failure to respond to the WO-ISA, SISR or IPER within this period (by

filing amendments and/or comments) leads to the application being deemed to be withdrawn according to Rule 161(1) (further processing is available for this loss of rights - see E-VII, 2.1). In all cases, the latest filed request on file after expiry of the time limit according to Rule 161(1) will then be taken into account when drafting the first communication (see E-VIII, 4.3.2) or when issuing the invitation under Rule 164(2) (see C-III, 2.3), provided that the application is not deemed to be withdrawn.

The communication under Rule 161(1) is issued promptly after expiry of the time limit for entry into the European phase.

In order to proceed with the examination of the application without having to wait until the expiry of the six-months time limit for response, the applicant may explicitly waive his right to a communication pursuant to Rules 161(1) and 162. Provided that on entry into the European phase, he has also already responded, where required, to the WO-ISA, the IPER or the SISR and paid the claims fees, no communication under Rules 161 and 162 will be issued. If this is not the case, the communication will be issued and the application will be processed only after expiry of the six-month period, even in the presence of a request under the PACE programme (see E-VII, 3.2).

Where the EPO is an elected Office, the international preliminary examination report and the documents attached to it must be considered in accordance with E-VIII, 4.3.

Where a translation of the priority is required (see A-III, 6.8, and F-VI, 3.4), an invitation to file it according to Rule 53(3) may be sent by the Examining Division only after the period according to Rule 161(1) has expired (see A-III, 6.8.2).

### **3.3 Exceptions where a reply to the Rule 161(1) invitation is not required**

#### **3.3.1 Earlier filed amendments or comments**

In certain cases, even though the EPO was the ISA or the SISA, the applicant is not required to respond to the communication under Rule 161(1). These exceptions are explained below:

- (i) If the applicant has filed new amendments and/or comments upon entry into the regional phase before the EPO, he will still be sent a communication according to Rule 161(1), but in this case he will not be required to respond to it (note, however, that if the requirements of Rule 137(4) were not fulfilled for amendments already filed, it is advisable to make the required indications in reply to the Rule 161(1) communication in order to avoid a further communication according to Rule 137(4)).

- (ii) If the applicant filed amendments according to Art. 19 and/or 34 PCT in the international phase and these amendments are maintained on entry into the European phase, and if the EPO prepared the WO-ISA or SISR but no IPER (either because the applicant did not demand Chapter II or because the IPEA was an office other than the EPO), then these amendments are considered to constitute a response to the WO-ISA or SISR; the applicant will still be sent a communication according to Rule 161(1) in such cases, but he will not be required to respond to it (note, however, that if the requirements of Rule 137(4) were not fulfilled for amendments already filed, it is advisable to make the required indications in reply to the Rule 161(1) communication in order to avoid a further communication according to Rule 137(4)).

With regard to the above cases (i) and (ii), however, see also E-VIII, 3.3.5. Furthermore, if amendments have been filed under Art. 19 or 34 PCT and have been taken into consideration in the drawing up of an IPER by the EPO acting as IPEA, these are not considered to constitute a response to the IPER as required by Rule 161(1); in these cases, the applicant is required to respond to the IPER within the six-month period according to Rule 161(1).

In cases (i) and (ii) above, no communication under Rule 161(1) or 162 is issued if the applicant has explicitly waived his right to these and has already paid any claims fees due (see the Notice from the EPO dated 4 May 2010, OJ EPO 2010, 352 and the Notice from the EPO dated 5 April 2011, OJ EPO 2011, 354).

### **3.3.2 Positive WO-ISA, SISR or IPER**

Where the WO-ISA, any supplementary international search report (SISR) or, where applicable, the IPER prepared by the EPO was positive (according to the same principles explained for European search opinions in B-XI, 3.9), the applicant is still sent a communication according to Rule 161(1), but is not required to respond to it. No communication under Rule 161(1) or 162 is issued if the applicant has explicitly waived his right to these and has already paid any claims fees due (see the Notice from the EPO dated 4 May 2010, OJ EPO 2010, 352).

### **3.3.3 Rule 161 communication issued before 1 April 2010**

In cases where the Rule 161 communication was already issued before 1 April 2010, there is no requirement to respond to the WO-ISA prepared by the EPO or to the IPER prepared by the EPO as IPEA; if the applicant has not filed any amendments or comments upon entry into the regional phase before the EPO, the first communication will essentially be based on the content of said WO-ISA or IPER prepared by the EPO.



### 3.3.4 Voluntary reply to Rule 161(1) communication

In cases (i) and (ii) mentioned in E-VIII, 3.3.1, and the case mentioned in E-VIII, 3.3.2, where the applicant is not required to respond to the WO-ISA, SISR or IPER prepared by the EPO (in response to the invitation under Rule 161(1)), he **may** still do so by filing further amendments and/or comments if he so wishes. Once again it is advisable that the requirements of Rule 137(4) are fulfilled for any such amendments when they are filed, thus avoiding a further communication according to Rule 137(4).

### 3.3.5 Indications on Form 1200

In all cases mentioned in E-VIII, 3.3.1, it is important that the applicant clearly indicates on Form 1200 which documents are to form the basis for further prosecution of the application (see the Euro-PCT Guide ("How to get a European patent, Guide for applicants, Part 2, PCT procedure before the EPO")). Failure to make the appropriate indications on Form 1200 and/or provide copies and/or translations of the amended application documents as indicated below will result in the applicant being required to respond to the invitation according to Rule 161(1).

*Form 1200*

In particular:

- In case (i) mentioned in E-VIII, 3.3.1, comments and/or amendments (the latter according to Rule 159(1)(b)) which are filed on entry into the European phase will be considered to constitute a response to the WO-ISA, the SISR or the IPER only if the applicant indicates on Form 1200 that such amendments and/or comments are to form the basis for further prosecution of the application and have been filed no later than the date of filing of Form 1200.
- In case (ii) mentioned in E-VIII, 3.3.1, amendments filed in the international phase will be considered to be a response to the WO-ISA, the SISR or the IPER only if the applicant indicates on Form 1200 that these amendments are maintained on entry into the European phase and also provides a translation thereof in the language of the proceedings, where necessary. Furthermore, a copy of the amendments under Art. 34 PCT (not made before the EPO as IPEA) would also be required no later than the date of filing of Form 1200.

### 3.4 Rule 137(4) applies

If the application is of one of the types mentioned in H-III, 2.1.4, and if amendments which are to form the basis for further examination were filed either during the Rule 161(1) time limit or earlier, the requirements of Rule 137(4) must be complied with (the amendments must be identified and the basis for them in the application as filed indicated). If the applicant has not yet complied with these requirements on expiry of the time limit according to Rule 161(1), the Examining Division may request him to provide this information within

*Rule 137(4)*

a period of one month, by issuing a communication according to Rule 137(4). Failure to respond to this communication in time will lead to the application being deemed to be withdrawn (see H-III, 2.1 and 2.1.1). The Examining Division may send a Rule 137(4) communication before sending a communication according to Art. 94(3) and Rule 71(1), (2) or (3). It should also be noted that a matching requirement applies to amendments made in the international phase (Rules 46.5, 66.8 and 70.2 PCT).

#### 4. Examination procedure

##### 4.1 At least one communication in examination

If deficiencies persist in the application even after the applicant has filed his response to the WO-ISA, supplementary international search report or IPER (as required by Rule 161(1)), the Examining Division will issue at least one communication according to Art. 94(3) and Rule 71(1) and (2) in subsequent examination proceedings and will consider the applicant's reply thereto before issuing a decision or a summons to oral proceedings. This applies regardless of whether a communication according to Rule 164(2)(a) has been issued.

##### 4.2 No examination of multiple inventions in EP phase

Although under PCT Chapter II, where the EPO is the IPEA, the applicant can have multiple inventions examined in one IPER if further examination fees have been paid (or if the examiner has chosen not to invite the applicant to pay further fees), in the European procedure only one invention will be examined.

*Rule 164(2)*

In cases where protection is sought for an invention not covered by the (supplementary) international search report, by the supplementary European search report or by a search carried out under Rule 164(2) because the search fee due was not paid, the Examining Division must invite the applicant to limit the application to one invention covered by one of these searches. The procedure under Rule 164(2) is set out in detail in C-III, 2.3.

*Rule 137(5)*

If after receipt of the (supplementary) European search report or, where applicable, after a communication under Rule 164(2)(b) the applicant files amended claims relating to an invention which differs from any of the originally claimed inventions and which does not combine with these inventions to form a single inventive concept, an objection under Rule 137(5) should be raised (see also F-V, 13, and H-II, 6).

##### 4.3 Substantive examination of a Euro-PCT application accompanied by an IPER

The substantive examination is conducted in the same way as with European applications. Where the EPO was the International Preliminary Examining Authority, the international preliminary examination will normally have been carried out by the examiner responsible for examining the related Euro-PCT application.

The application to be examined will be accompanied by an international preliminary examination report drawn up in one of the official languages of the EPO. New documents in the original language may be attached in annex to the report (Art. 36(3)(a) PCT and Rule 70.16 PCT). The application will also be accompanied by a translation of the annexes, transmitted by the applicant, in the same language into which the international preliminary examination report was translated (Art. 36(3)(b) PCT).

*Art. 14(1)*

The examination must be conducted in accordance with Art. 41 and 42 PCT, which stipulate that:

*Art. 41 and 42 PCT*

- (i) the applicant must be given the opportunity to amend the claims, the description and the drawings within a time limit prescribed pursuant to Rule 78.1(b) or 78.2 PCT (see also Rules 159(1)(b) and 161); and
- (ii) the EPO cannot require that the applicant furnish copies, or information on the contents, of any papers connected with the examination relating to the same application in any other elected Office.

*Rule 159(1)(b)*  
*Rule 161*

#### **4.3.1 Comparative test results**

Where the EPO has established the IPER and refers therein to the submission of test reports, the applicant is taken to agree to the use of these reports as the basis for proceedings before the EPO when he uses the standard form for entry into the European phase before the EPO as elected Office, i.e. Form 1200. If the latter is not used or the IPER – referring to the test reports – was established by another International Preliminary Examination Authority, the applicant is invited to submit these reports for the European application.

#### **4.3.2 Basis for substantive examination**

Normally, the documents which are indicated in the international preliminary examination report as forming the basis for that report will also form the basis for the substantive examination in the EPO as an elected Office in the European phase. New documents (claims, description, drawings) submitted during the international preliminary examination and replacing the earlier filed documents will be attached to the international preliminary examination report. If the documents attached to the international preliminary examination report are in a language other than the language of the proceedings of the European application in the European phase, the applicant must be requested to file the documents in the language of the proceedings within a fixed period.

The applicant may also request that the examination be based on the documents in the international application as published or on amendments made on entry into the European phase. If the declarations of the applicant are unclear in this respect, the examiner will have to clarify the situation.

### **4.3.3 Consideration of the contents of the IPER**

*Rule 161(1)*  
*Rule 159*

If the international preliminary examination report has been drawn up by the EPO, it is to be regarded as an opinion for purposes of examination, and generally the first communication will be based on the opinion expressed in the IPER and the applicant's response to it filed in accordance with Rule 161(1) (if applicable, see E-VIII, 3). Such an opinion may be departed from if new facts relevant to assessing patentability are in evidence (e.g. if further prior art documents are to be cited or if evidence is produced of unexpected effects), where the substantive patentability requirements under the PCT and the EPC are different, where the applicant provides convincing arguments, appropriate amendments or relevant counter-evidence in his response to the IPER according to Rule 161(1), or conversely where the applicant provides amendments in response to the IPER which introduce further deficiencies.

Examination reports drawn up by other International Preliminary Examining Authorities must be examined carefully. If the reasons put forward in the international preliminary examination report are sound, they must not be disregarded.

## Chapter IX – Decisions

### 1. Basis of decisions

#### 1.1 General remarks

The decisions of the EPO may only be based on grounds or evidence on which the parties concerned have had an opportunity to present their comments. *Art. 113(1)*

This provision is intended to ensure that no party can be taken by surprise by grounds for a decision against his application on which he did not have an opportunity to present his comments.

In substantive examination, the applicant must have an opportunity of presenting his comments on all the grounds invoked against his application.

Before an application is refused, the search under Art. 54(3) should be completed.

In opposition proceedings, if the patent is to be revoked, it should be ensured that the proprietor of the patent in particular is given sufficient opportunity to defend himself and, similarly, if the oppositions are to be rejected or if, despite the claims of the opponents, the patent is to be maintained in amended form, the opponents in particular should be given the same opportunity. A decision may be based on grounds indicated in a document from one of the parties, provided the document has been sent to the other party so that he has had an opportunity to comment.

If more than two months have elapsed between despatch of the document "only for information" and the issue of the decision, this generally means that the party has had sufficient opportunity to comment and his right to be heard has therefore not been infringed (T 263/93).

If the patent is to be maintained in amended form, there must be a text of the claims and description which has been approved by the patent proprietor (D-VI, 2), and the opponent(s) must have had an opportunity to comment on it.

#### 1.2 Examples

The right to be heard is a right not just to present comments but also to have those comments duly considered. Amendments and arguments submitted by a party need to be considered, and the party must be given an opportunity to comment on the grounds and evidence brought forward by the Examining Division (see T 1123/04 and T 852/07). A document should not be cited for the first time in a decision (see T 635/04) unless it has been introduced during oral proceedings. The use of fresh arguments in a decision still based on

grounds and evidence communicated beforehand is not precluded (see T 268/00 and T 1557/07).

If a case is remitted from the Boards of Appeal for further prosecution, the Examining Division must check whether requests from examination proceedings prior to the appeal are still outstanding and must give the party an opportunity to comment (see T 1494/05). If the facts and grounds essential to a decision have been submitted by one party and if the party whose case is to be rejected has been afforded sufficient time to comment, the principle concerning the right to be heard set out in Art. 113(1) will have been respected. If the decision in opposition proceedings is to be based on grounds which were raised in the examination proceedings but not in the notice of opposition, the observations by the parties or the communications of the Opposition Division, these must be introduced (i.e. raised for discussion) by the Opposition Division in the opposition proceedings before the decision is given so as to afford the parties an opportunity to comment. If the opposition is based on lack of inventive step, the proprietor of the patent must expect that the prior art newly designated in the opposition proceedings will be considered in conjunction with the prior art described in the introductory part of an independent claim. However, if new facts and grounds are introduced during the proceedings or if the facts and grounds on which the envisaged decision is to be based were not stated so unambiguously and clearly in the written submissions of the parties as to give a party occasion to comment, the party concerned must be given an opportunity to submit an opinion and to produce evidence before the decision is given.

A patent proprietor's right to be heard has not however been violated if he makes only minor amendments to the claims in response to a communication from the Opposition Division setting out the material arguments against maintaining the patent as it stands, with the result that the grounds for revoking the patent remain essentially unchanged, provided the proprietor's comments have been duly considered.

In such a case, where the obstacles to maintenance have already been put to the proprietor and continue to apply, the patent may be revoked immediately, without any need to communicate again the full arguments on which the decision would be based.

## **2. Consideration of time limits**

A decision may not be given until any time limit set has expired, unless all the parties affected by the time limit expressly agree that it need no longer be observed or have submitted their final opinions before it expires. The decision to grant a patent may be given once the applicant is deemed to have approved the text submitted to him under Rule 71(5) and has fulfilled all other formal requirements, even if the time limit set in the Rule 71(3) communication has not yet expired.

Moreover, as a rule, decisions should not be given until an internal EPO time limit (e.g. 20 days) following upon the official time limit (but from which the parties may derive no rights) has expired, so as to ensure that documents received at the end of the period officially allowed have actually been entered in the files when the decision is being taken and can be taken into account in the decision.

With reference to submissions and applications received after expiry of a time limit, see E-VII, 1.8.

### **3. Authoritative text of documents**

The EPO must decide upon the European patent application or the European patent only in the text submitted and agreed by the applicant or proprietor and last used as a basis for the proceedings. Consequently, for example, an amended version proposed by the Examining or Opposition Division (see C-V, 1.1, D-VI, 4.2 and 7.2.1) may only be adopted as a basis for the decision if it has been approved by the applicant or proprietor.

*Art. 113(2)*

In the case of one or more auxiliary requests directed to alternative texts for grant or maintenance of a patent, every such request qualifies as a text submitted or agreed by the applicant or proprietor within the meaning of Art. 113(2) (see T 234/86), and therefore must be dealt with in the order indicated or agreed to by the applicant or proprietor, up to and including the highest-ranking allowable request, if any.

When considering such requests it is essential that they are treated in the correct order. Thus, for instance, if the only allowable request is an auxiliary request, but is accompanied by a higher auxiliary request for oral proceedings (e.g. a request that oral proceedings be held if the main request cannot be granted) then a communication under Rule 71(3) could not be issued on the basis of the allowable request, but instead oral proceedings in accordance with the higher request would have to be appointed, or a further communication under Rule 71(1) issued (see E-IX, 5.3). If the order of the requests is not clear from the applicant's submissions, then it would be necessary to contact the applicant to clarify the situation before proceeding.

## **4. Written form of decisions**

### **4.1 General remarks**

Decisions are to be produced in writing. The same applies to decisions delivered at the end of oral proceedings (see E-II, 9).

*Rule 111(1)*

No complete rules can be laid down about the form and content of decisions, which will depend on the requirements of each particular case.

The written decision will contain:

- the names of the parties to the proceedings (applicant, proprietor, opponents) and, if applicable, their representatives;
  - the order, and, if necessary;
  - the facts and submissions;
  - the reasoning;
  - the communication of the possibility of appeal (Rule 111(2)); and
- Rule 113(1)*
- the signature(s) and the name(s) of the employee(s) responsible.

If the decision is produced by the employee responsible using a computer, the EPO seal may replace the signature. If it is produced automatically by a computer the employee's name may also be dispensed with (Rule 113(2)). The file copy contains the names and the actual signature(s) of the employee(s) responsible.

If, exceptionally, one or more Division members cannot sign the decision, e.g. owing to extended illness, only a Division member who was present at the oral proceedings (preferably the chairman) may sign it on their behalf (see T 243/87). A written decision signed by someone who did not take part in the oral proceedings at which the decision was pronounced is not legally valid (see T 390/86).

The presentation of the facts and the submissions, the reasoning and the communication of the means of redress are generally omitted when a decision merely meets the requests of all the parties concerned; this applies in particular to the decision to grant, which is based on the documents that the applicant has approved (Rule 71(5)). The same applies when the patent is maintained in an amended form, because this is preceded by a final interlocutory decision pursuant to Art. 106(2) concerning the documents on which the maintenance of the patent is to be based (see D-VI, 7.2.2). In individual cases, consideration may also be given to the reasoning of those decisions which merely meet the requests of the parties. If, for example, a number of reasons are invoked for a request for re-establishment, of which only one justifies re-establishment, a reasoned decision on re-establishment may be appropriate, in order to clarify the official action.

Even in those cases in which the decision contains no communication of the means of redress, an appeal can be filed if the decision is incorrect, e.g. if the grant was not made on the basis of the documents that the applicant had approved.



## 4.2 Order

The order may be, for example, as follows:

"The European patent application ... is hereby refused pursuant to Art. 97(2) EPC.";

"The opposition to the European patent ... is hereby rejected."; or

"The request for re-establishment of rights is hereby rejected".

## 4.3 Facts and submissions

Facts and submissions have to be given insofar as they are significant for the decision.

Under facts, a brief description of the case and a summary of the main reasons on which the decision is based and of the most important replies of the parties should be given. These points, however, are to be covered in detail in the subsequent reasoning. Facts and submissions which are irrelevant to the decision, e.g. requests for amendment which are not maintained, are to be omitted.

The facts and submissions must clearly indicate what is the subject of the application and show on which documents (in particular which claims) the decision is based. The text of the independent claim(s) and other especially important claims or passages of the description on which the decision is based must be cited verbatim in the language of the proceedings (Rule 3(2)) either by copying the text into the decision or annexing a copy of the claims. As regards the dependent claims, it may be sufficient to refer to the file content.

## 4.4 Decision on the file as it stands

Applicants may request a decision "on the file as it stands" or "according to the state of the file", e.g. when all arguments have been sufficiently put forward in the proceedings and the applicant is interested in a speedy appealable decision. C-V, 15 and sub-sections, describes the procedure to be followed in case of such a request.

## 5. Reasoning of decisions

The statement of grounds must first set out and substantiate why the Division is of the opinion that no patent can be granted, citing the individual EPC articles and rules involved.

The Division will draft the decision based on one or more grounds forming the basis of the decision, as appropriate. It is essential in such cases that the parties should have been given an opportunity to comment on all the grounds on which the decision is based.

When several grounds are used in the decision, it is imperative to link them in a logical way, in particular avoiding that a subsequent ground

contradict a preceding one. Furthermore, the chain of grounds should be structured so that it starts with the main ground.

*Example:*

Often an application lacking an inventive step also lacks clarity. The decision must clearly set whether the application is refused because the subject-matter of the claims is unclear and would also lack inventive step once clarified or whether it is refused because the subject-matter of the claims lacks inventive step and would have to be clarified once the inventive step objection is overcome.

Art. 113(1)  
Rule 111(2)

The reasoning for each of the grounds on which the decision is based must contain, in logical sequence, those arguments which justify the order. It should be complete and independently comprehensible, i.e. generally without references. If, however, a question has already been raised in detail in a particular communication contained in the file, the reasoning of the decision may be summarised accordingly and reference may be made to the relevant communication for the details.

The conclusions drawn from the facts and evidence, e.g. publications, must be made clear. The parts of a publication which are important for the decision must be cited in such a way that those conclusions can be checked without difficulty. It is not sufficient, for example, merely to assert that the cited publications show that the subject of a claim is known or obvious, or, conversely, do not cast doubt on its patentability; instead, reference should be made to each particular passage in the publications to show why this is the case.

The arguments put forward by the examiner during the proceedings should form the "skeleton" for the decision and already define a complete and unbroken chain of reasoning leading to refusal. The decision may be based only on reasons already communicated to the applicant (Art. 113(1)). The applicant's arguments must be dealt with either point by point at the appropriate juncture in the chain of reasoning or en bloc at the end. The latter approach is often preferable as it makes clear that the final result is based solely on reasons already communicated to the applicant in compliance with Art. 113(1). In the part refuting the applicant's arguments, the decision should make clear why none of those arguments persuaded the examining division to depart from the final result.

It is particularly important that special attention should be paid to important facts and arguments which may speak against the decision made. If not, the impression might be given that such points have been overlooked. Documents which cover the same facts or arguments may be treated in summary form, in order to avoid unnecessarily long reasoning.

The need for complete and detailed reasoning is especially great when dealing with contentious points which are important for the decision; on the other hand, no unnecessary details or additional reasons should be given which are intended to provide further proof of what has already been proven.

The decision is a standalone document and should include the statement that the application is refused. This serves to indicate that, in case of several grounds, all of them form the basis for the refusal.

The decisions should not contain any matter on which the parties have not had an opportunity to comment.

### **5.1 Content**

The decision should normally deal with all independent claims of the valid request(s) that were discussed during the proceedings. A single ground is enough to refuse an application, so it is not always necessary to deal with all the dependent claims. If however a particular dependent claim has been discussed, the decision should include the relevant arguments.

Any additional requests still outstanding must be dealt with in the refusal decision. If, for example, new oral proceedings were requested in circumstances where Art. 116(1), second sentence, applies, the decision should give the reasons for rejecting that request.

Formulations implying doubt or uncertainty, such as "seems" or "apparently", should be avoided in decisions.

### **5.2 Analysing the parties' arguments**

All significant arguments advanced by a losing party to the proceedings should be carefully examined and comprehensively refuted in the decision. The decision must substantiate the Division's view that none of the submitted arguments overcome the objections it has raised.

However, facts not in dispute need be mentioned only briefly. Arguments by the parties which are clearly irrelevant to the issues involved do not need to be discussed.

### **5.3 Main and auxiliary requests**

If during **examination proceedings** a main and auxiliary requests have been filed (see E-IX, 3) and none of these is allowable, the reasons for the decision to refuse the application pursuant to Art. 97(2) must not be limited to the main request, but must also comprise the reasons for the non-allowability of each auxiliary request. If one of the requests is allowable, the communication pursuant to Rule 71(3) is to be issued on the basis of the (first) allowable request and must be accompanied by an explanation of the reasons why the higher-ranking requests are not allowable (see

C-V, 1.1). Should the applicant, in response to the communication pursuant to Rule 71(3), maintain higher-ranking requests which are not allowable, a decision to refuse the application pursuant to Art. 97(2) will normally be issued (see C-V, 4.7 and 4.6.2); the reasons must set out the grounds for the non-allowability of each request which ranks higher than the allowable request. In respect of the allowable request, the decision to refuse must mention that the applicant has failed to give his approval to it.

Similarly, if in **opposition proceedings** the proprietor has submitted in addition to his main request one or more auxiliary requests, none of which is allowable, the patent must be revoked and the decision must set out, in respect of each request submitted and maintained by the proprietor, the reasons for not allowing it. Where one of the proprietor's requests directed to the maintenance of the patent in amended form is allowable, an interlocutory decision is to be issued on the basis of the (first) allowable request; it has to set out the reasons why this request meets the requirements of the EPC and, additionally, the reasons why the higher-ranking requests do not.

Insofar as a decision includes the rejection of any of the multiple requests, such decision may not be taken until the applicant or proprietor has been informed, with respect to each of these requests, of the reasons for not allowing them, so that the applicant or proprietor is not deprived of the opportunity to present comments (Art. 113(1) – right to be heard). Similarly, an opportunity to comment must be granted to the opponent(s) with respect to an auxiliary request before it is held allowable by an interlocutory decision (see D-VI, 7.2).

Practical considerations will determine at which point in the decision the auxiliary request is dealt with.

#### **5.4 Late-filed submissions**

If an Examining or Opposition Division has exercised its discretion under Rule 116 to refuse late-filed facts, evidence or requests, its decision must give the reasons for its refusal. A mere reference to the discretionary power given under Rule 116 is not sufficient. The same applies to the exercise of an Examining Division's discretion to refuse amendments under Rule 137(3) (see T 755/96). For details on how to exercise this discretion, see H-II, 2.7.

#### **6. Decisions which do not terminate proceedings – interlocutory decisions**

Interlocutory decisions may be given in principle. However, it should be borne in mind that pursuant to Art. 106(2), a decision which does not terminate proceedings as regards one of the parties can only be appealed together with the final decision, unless the decision allows separate appeal.

*Rule 116*  
*Rule 137(3)*

*Art. 106(2)*

====

The competent department should use its discretion as to the need for an interlocutory decision (see, however, D-VI, 7.2.2 with respect to the interlocutory decision for maintenance of a patent in amended form in opposition proceedings). To avoid fragmentation of the proceedings, such decisions should be the exception rather than the rule and should be given only if the duration or cost of the proceedings as a whole is thereby reduced. The interests of the parties should also be borne in mind as appropriate. In the normal course, an interlocutory decision should be contemplated only for the purpose of ruling that separate appeal may be made, as only in this way can a decision be obtained on a preliminary point before the final decision terminating the proceedings is reached. (The proceedings must be suspended until the decision has become final.) It is especially important to allow separate appeal where the continuation of the proceedings depends on a preliminary ruling on a fundamental point of law, e.g. where different Boards of Appeal have given different rulings or conflicting decisions have been given by different Examining or Opposition Divisions and no decision on appeal has been given in the matter. Interlocutory decisions must state the reasons on which they are taken; if it is decided not to allow separate appeal, the reasons for this ruling may be given only in the final decision.

#### **7. Binding nature of decisions on appeals**

If a department has to give a decision in a case which has already been remitted by the Board of Appeal for further prosecution to that department, it is bound by the *ratio decidendi* of the Board of Appeal, insofar as the facts, e.g. the subject-matter of the patent and the relevant state of the art, are the same.

*Art. 111(2)*

An Opposition Division is not bound by a decision of a Board of Appeal on appeal against a decision from an Examining Division (see T 167/93). The exclusive phrasing of the last sentence of Art. 111(2), only mentioning the Examining Division being bound by the decision on appeal against a decision of the Receiving Section, makes this clear. Opposition proceedings are entirely separate from the examination proceedings, and the Opposition Division is entitled to examine the facts, evidence and arguments anew, particularly since another party (the opponent) is now involved. It should, however, take due notice of the assessment of these facts, evidence and arguments as contained in the reasons of the decision of the Board of Appeal.

#### **8. Information as to means of redress**

Decisions of the EPO which are open to appeal must be accompanied by a written communication of the possibility of appeal. The communication must also draw the attention of the parties to the provisions laid down in Art. 106 to 108 and Rules 97 and 98, the text of which must be attached. The parties may not invoke the omission of the communication.

*Rule 111(2)*

**9. Notification**

*Art. 119*

Decisions must be notified as a matter of course (see E-I, 2).

## Chapter X – Appeals

### 1. Suspensive effect

The Boards of Appeal are not bound by any instructions. Therefore this chapter deals in detail only with those questions which are relevant for interlocutory revision. At this stage of the proceedings the department of first instance is still competent.

*Art. 23(3)*

*Art. 109*

Appeals shall lie from decisions of the Receiving Section, Examining Divisions, Opposition Divisions and the Legal Division.

*Art. 106(1)*

An appeal has suspensive effect. This means that decisions may not yet become final and their effects are suspended. As the decision may not then be enforced, the following do not take place: entry in the Register of European Patents, mention in the European Patent Bulletin and, where appropriate, publication of a new specification of the European patent.

### 2. Appeals after surrender or lapse of the patent

An appeal may be filed against the decision of the Opposition Division even if the European patent has been surrendered or has lapsed for all the designated States.

*Rule 98*

### 3. Appeals against the apportionment of costs

The apportionment of costs of opposition proceedings cannot be the sole subject of an appeal. A party to the proceedings who feels that he has been adversely affected by the apportionment of costs may therefore only file an appeal against the decision on costs if he also lodges an appeal against the decision on the opposition on other admissible grounds.

*Rule 97(1)*

### 4. Appeals against the decision of the Opposition Division on the fixing of costs

In accordance with Rule 97(2), the decision of the Opposition Division fixing the amount of costs of opposition proceedings may be appealed if the amount is in excess of the fee for appeal.

*Rule 97(2)*

*Art. 13 RFees*

### 5. Persons entitled to appeal and to be parties to appeal proceedings

Any party to proceedings adversely affected by a decision may appeal. Any other parties to the proceedings are parties to the appeal proceedings as of right.

*Art. 107*

### 6. Time limit and form of appeal

Notice of appeal must be filed with the EPO within two months of the date of notification of the decision appealed from. The notice is not deemed to have been filed until after the fee for appeal has been paid in the amount laid down in the Rules relating to Fees under the EPC. Within four months after the date of notification of the decision, a written statement setting out the grounds of appeal must be filed.

*Art. 108*

## 7. Interlocutory revision

### 7.1 General remarks

*Art. 109(1)*

If the department whose decision is contested considers the appeal to be admissible and well founded, it must rectify its decision. This does not apply where the appellant is opposed by another party to the proceedings.

The obligation or possibility of rectification may thus arise in connection with a decision by the Receiving Section, the Legal Division or an Examining Division. In opposition proceedings, it only arises in the special case that all the notices of opposition have been withdrawn and the proprietor of the patent files an appeal.

*Art. 109(2)*

After receipt of the statement of grounds, only three months are available for rectification of the decision by the department of the first instance. That department must therefore consider the appeal with the highest priority and start the examination on admissibility immediately, and if the appeal is considered admissible in the form in which it has been filed, the competent department will start its examination on allowability immediately.

The department concerned will rectify its decision if convinced in the light of the grounds of appeal that the appeal is admissible and well founded. This could arise, for example, because:

- (i) the department failed to take due account of some of the material available to it at the time the decision was made;
- (ii) the department did not receive material filed at the EPO in due time before the issue of the decision, owing to an office error; or
- (iii) the decision of the department concerned does not appear to be incorrect, but the applicant presents new information or evidence or files amendments to the application, which overcome the objections of the decision under appeal (see T 139/87).

For the advantages of a decision covering more than one objection, see E-IX, 5.

The decision to allow interlocutory revision must be signed by all members of the Division as soon as they are available, even if this is after expiry of the three-month time limit.

In either case, whether the appealed decision is rectified or the appeal is remitted to the Board, the decision may be signed only by examiners belonging to the Division at the time of signature. If an examiner is absent for a long period or has left the department, a new member must be appointed to the Division.



## 7.2 Remittal to the Board of Appeal

If the appeal is not allowed within three months after receipt of the statement of grounds, it must be remitted to the competent Board of Appeal without delay, and without comment as to its merit. This means that the department of first instance should address no comments of substance to the Board. Internal notes made by Division members about the merits of the appeal should be kept in the non-public part of the dossier and should not be sent to the Board of Appeal.

*Art. 109(2)*

The receipt of the statement of grounds of appeal is a prerequisite for the Examining Division when deciding whether the appeal is well-founded. Such statements can be filed at any time within four months from the notification of the decision (Art. 108). Therefore, the Examining Division will wait until the expiry of this four-month time limit before deciding whether to allow interlocutory revision or to remit the appeal to the Board to ensure that the full content of the statement of grounds has been received.

---

## 7.3 Reimbursement of appeal fees

In the event of interlocutory revision, reimbursement of appeal fees will be ordered by the department whose decision has been impugned if such reimbursement is equitable by reason of a substantial procedural violation. This is particularly the case when essential facts or evidence were not taken into consideration in arriving at a decision, e.g. where a document filed at the EPO in good time by the party concerned is not placed in the file before a decision is reached or where the decision is based on facts or evidence on which the party concerned had no opportunity of presenting his comments. The appeal fee is to be reimbursed, even if this was not explicitly requested by the appellant (see G 3/03).

*Rule 103(1)(a)*  
*Art. 109*

If the decision is rectified by an interlocutory revision not because of any substantial procedural violation but e.g. because the party concerned submits amendments at the time of filing the appeal, there will be no reimbursement of appeal fees.

If the department whose decision is contested considers the requirements of Art. 109 for interlocutory revision to be fulfilled, but not the requirements of Rule 103(1)(a) for reimbursement of the appeal fee, it must rectify its decision and remit the request for reimbursement of the appeal fee to the board of appeal for a decision (see J 32/95).

The request for reimbursement of the appeal fee will be remitted to the board of appeal only if it was filed together with the appeal (see G 3/03 and T 21/02).

## 7.4 Examples

### 7.4.1 No amended claims filed with the appeal

If the applicant has filed an appeal but no amended claims, the Division should check whether the decision was correct in substance. Interlocutory revision should only be made if the decision was not correct in substance. A refund of the appeal fee is to be ordered if a substantial procedural violation has occurred (see E-X, 7.3). If interlocutory revision is made and new objections arise, the Division should communicate these objections to the applicant as often as necessary to reach a final decision on the file; this could include holding oral proceedings (again) and/or a second refusal.

#### *Example:*

The applicant points out in the letter of appeal that the Examining Division has overlooked a request for oral proceedings.

The Examining Division looks at the file and notes that this was indeed the case: interlocutory revision must be made, even if it results in a further refusal after oral proceedings have been held. The appeal fee must be refunded.

### 7.4.2 Amended main/single request filed with the appeal

If amendments made to the independent claims clearly do not meet the requirements of Art. 123(2), interlocutory revision should not be granted, but the Division should send the file to the Boards of Appeal. If, on the other hand, there are doubts as to whether the amendments meet the requirements of Art. 123(2) or the amendments clearly meet the requirements of Art. 123(2), the Division should check whether the amended claims overcome the ground(s) for refusal as well as all previous objections to patentability to which the applicant has had an opportunity to respond. If this is not the case, interlocutory revision should not be granted, but the Division should send the file to the Boards of Appeal.

If the amendments clearly overcome the grounds for the refusal, interlocutory revision should be granted even if further new objections arise. This is because the applicant has the right to examination in two instances (see T 219/93).

Important criteria are (see T 47/90):

1. the text is no longer the same (or equivalent)
2. substantial amendments have been made.

Normally, amendments which do not change anything vis-à-vis the documents already cited in the decision (still not novel, still not inventive) are not regarded as "substantial", i.e. necessitating an interlocutory revision. The examiner has the discretion to decide

whether, in each particular case, the amendments to the claims are such that examination has to be continued on a new basis, e.g. where a completely new line of inventive-step argumentation would be necessary.

In making this decision, not only the grounds mentioned in the decision should be taken into account but also all previous objections to patentability to which the applicant has had an opportunity to respond (e.g. objections mentioned in an *obiter dictum* of the decision, or objections mentioned in previous communications, during personal consultation or at oral proceedings). This is in the interest of procedural efficiency and to the benefit of the applicant (no second appeal fee necessary).

*Examples:*

- (a) The applicant has included a wording that has already been suggested by the examiner, the new claims are ready for grant but the description needs to be adapted: interlocutory revision must be granted since the grounds for the refusal have been overcome.
- (b) **Refusal for lack of novelty only.** New claims are clearly novel but not inventive. The question of inventive step had not been raised in the decision or in the previous procedure: there must be an interlocutory revision.
- (c) **Refusal for lack of novelty.** New claim 1 filed which includes a feature from dependent claim 3. This claim had already been discussed in the decision and was considered not to be inventive: no interlocutory revision.
- (d) **Refusal for lack of novelty over D1.** New claim 1 filed which includes a feature from the description. This feature had not been previously discussed *per se*; however, it is clearly disclosed in D1: no interlocutory revision since the ground for refusal – lack of novelty over D1 – has not been overcome.
- (e) **Refusal for lack of inventive step vis-à-vis D1 and D2.** New claims filed which include a feature from the description. This feature had not been previously discussed, but is clearly disclosed in D1 and would not need a (major) change in the argumentation given: no interlocutory revision since the ground for refusal - lack of inventive step vis-à-vis D1 and D2 - has not been overcome.
- (f) **Refusal for lack of inventive step vis-à-vis D1 and D2.** New claim filed which includes five new features from the description. These features have not been previously discussed. The examiner notes that although these features are disclosed in D2, the lack-of-inventive-step argumentation

would have to be substantially revised: interlocutory revision should be made, since (i) the applicant has made substantial amendments to overcome the objections raised in the decision and (ii) the line of argumentation has to be substantially revised.

#### **7.4.3 Main and auxiliary requests filed with the appeal**

Interlocutory revision is never possible on the basis of an auxiliary request, even if an auxiliary request would overcome the grounds for the decision (T 919/95).

##### *Example:*

The main request is the same as the one refused (i.e. not amended). However, the auxiliary request corresponds to a suggestion made by the Examining Division and would thus be allowable. There can be no interlocutory revision since the applicant has the right to have his main request examined by the Boards of Appeal.

### **8. Rules of Procedure for the departments of second instance**

Details of the procedure before the Boards of Appeal can be found in the Rules of Procedure of the Boards of Appeal (see OJ EPO 2003, 89). The Enlarged Board of Appeal has also adopted Rules of Procedure (see OJ EPO 2007, 303).

### **9. Remittal to the Division after appeal**

#### **9.1 Orders on remittal**

If a decision by an Examining or Opposition Division is appealed, the Board of Appeal may remit the case to the Division under Art. 111(1). In such cases, the exact wording of the orders must be complied with. Various situations may arise:

- (a) The case is remitted for grant or maintenance in amended or limited form on the basis of a complete text which has been finally decided by the Board.
- (b) The case is remitted for the description to be brought into line with claims whose wording has been finally decided by the Board.
- (c) The case is remitted for further prosecution.

#### **9.2 Consequences for the Division**

In situation (a) above, grant or maintenance is handled by the formalities officer, and the dossier goes back to the Division merely for checking the classification and title and adding any references to supplementary technical information (STIN) or newly cited documents (CDOC).

In situation (b) above, the Board has taken a final decision on the wording of the claims which ends the matter. The Division can no longer amend the claims or allow the applicant or proprietor to do so, even if new facts (e.g. new relevant citations) come to light (see T 113/92, Headnote No.2, and T 1063/92, Headnote, second paragraph). Corrections under Rule 139, however, may still be allowable.

Applicants and proprietors should exercise all possible procedural economy when bringing the description into line with the claims' wording as decided by the Board of Appeal. Normally, therefore, completely retyped texts should not be accepted (see T 113/92, Headnote No. 1).

In situation (c) above, the Division whose decision was appealed is bound by the Board's *ratio decidendi*, in so far as the facts are the same (Art. 111(2)). However, new relevant documents or facts which come to light must be taken into account. In particular:

- (a) the parties must be given the opportunity to submit further requests, and
- (b) the Division must check whether requests from examination or opposition proceedings prior to the appeal (e.g. for oral proceedings) are still outstanding - see T 892/92, Headnote.



## Chapter XI – Request from a national court for a technical opinion concerning a European patent

### 1. General

At the request of the competent national court trying an infringement or revocation action, the EPO is obliged, against payment of an appropriate fee, to give a technical opinion concerning the European patent which is the subject of the action. The Examining Divisions are responsible for the issue of such opinions. *Art. 25*

Only requests from a national court in a Contracting State will be accepted by the EPO. It is not, however, up to the EPO to check whether the requesting court is "competent" to deal with the action or not. The Examining Division, however, should check whether a European patent is the "subject of the action".

The Examining Division responsible for the technical opinion should give the parties an opportunity to submit arguments in writing if the court so permits. However, the parties have no right to be heard before the EPO. Nevertheless, where the Examining Division considers it necessary, it may invite the parties, via the court and provided that the court so permits, either to be heard before the Examining Division or to submit supplementary observations on specific points identified by the Examining Division. If the parties are heard, such a hearing is not considered to constitute oral proceedings within the meaning of Art. 116.

The technical opinion is not a decision of the EPO. The parties to the national proceedings therefore have no right of appeal before the EPO against an unfavourable opinion.

### 2. Scope of the technical opinion

The Examining Division is obliged to give a "technical opinion" upon request. This means that the Division is bound to give an opinion only insofar as the questions put are of a technical character. However, the Examining Division should not be too restrictive in this regard but should attempt to assist the national court as much as is reasonably possible, while remembering that the actual decision on infringement or revocation is exclusively a matter for the national court.

Generally speaking, the Examining Division should attempt to give a technical opinion on any question which is similar to those normally dealt with in European substantive examination work, even when the question has a legal, as well as a technical, aspect. On the other hand, the Examining Division should decline to make any specific statement on whether a patent is valid or on whether it is infringed. It should also not give any opinion on the extent of protection (Art. 69 and the accompanying Protocol).

A request from a national court is to be expected to be clearly and precisely formulated, so that the Examining Division will be in no doubt as to the questions on which the court wishes to have an opinion. Since the court is responsible for deciding the issues of law involved in the questions and since most questions include a mixture of legal and technical aspects, the court is expected where possible to separate clearly the legal aspects from the technical aspects upon which it seeks the opinion of the EPO.

### **3. Composition and duties of the Examining Division**

#### **3.1 Composition**

The composition of the Examining Division to which the request is referred must be as defined in Art. 18(2). This means that the Division must include three technical examiners; normally a legally qualified examiner will also be included. The main responsibility for dealing with the request up to the time of formulating the opinion is entrusted to one technical examiner, hereinafter referred to as the "primary examiner".

In order to guarantee that the opinion given is not influenced by earlier proceedings within the EPO on the application/patent in question, examiners who have taken part in such earlier proceedings as members of an Examining or Opposition Division should be excluded from the Examining Division set up under Art. 25. Where this is not practicable, the national court and the parties should be informed of the proposed members of the Examining Division under Art. 25 and of which among these members participated in European examination or opposition proceedings on the case. The court should be asked to state whether, in the circumstances, the request for a technical opinion is maintained.

#### **3.2 Duties**

The primary examiner will act on behalf of the Examining Division and will normally be responsible for issuing communications to the court. The primary examiner should also draft the written opinion and should circulate the draft to the other members of the Examining Division for consideration. If any changes are proposed in the draft and there are differences of view on such changes, the Chairman should arrange a meeting to resolve the matter. The final opinion should be signed by all members of the Division.

### **4. Language to be used**

In principle the language to be used should be the language of the proceedings of the European patent; however, if the court so requests, another official language of the EPO may be used. At least the request itself, any submissions from the parties, and any amendments to the patent should be in that language or translated into that language. The opinion should also be produced in that language. However, where appropriate, the Examining Division should pay regard to the provisions of Art. 70(2) to (4).



Regarding documents to be used as evidence, the provisions of Rule 3(3) apply (see A-VII, 3).

The court or the parties are responsible for providing any translations which may be required to satisfy the above conditions.

## **5. Procedure**

It is envisaged that the procedure will normally involve the following stages.

### **5.1 Formalities check**

The formalities officer will check whether the fee has been paid and whether there are any obvious deficiencies as to the language requirements. If there are any deficiencies in these respects, the formalities officer will write to the national court informing it that no substantive work on the opinion will begin until the deficiencies have been remedied. However, no time limit can be imposed on the court.

*Art. 2, No. 20, RFees*

If the file indicates that the court permits the parties to submit written arguments to the EPO and such arguments are not already on the file, the formalities officer will write via the court to the parties giving them a time limit (say two months) for submitting such arguments.

### **5.2 Preliminary examination**

When the formal requirements have been met, and, where appropriate, the arguments of the parties are on file, the case will be referred to the directorate responsible for the technical field of the patent in order for the Examining Division to be established. Assuming that an Examining Division consisting entirely of new members can be formed or, where this is not possible, that the court maintains its request for a technical opinion (see E-XI, 3), the primary examiner will perform a preliminary examination to determine whether:

- (i) the questions put by the national court are such as the Examining Division is competent to answer, at least in part; and
- (ii) the papers filed are sufficiently complete and the necessary translations have also been filed.

If there are any deficiencies in these respects, the primary examiner will write to the national court accordingly.

### **5.3 Withdrawal of the request**

If the request for a technical opinion is withdrawn before the Examining Division starts any substantive work on the opinion, 75% of the fee will be refunded.

*Art. 10 RFees*

**5.4 Establishment and issue of the technical opinion**

After any deficiencies as referred to in E-XI, 5.1 or 5.2, above have been met, the Examining Division should establish the technical opinion as soon as possible.

The opinion should be sent to the national court. Any papers received from the court which belong to the national proceedings should be sent back with the opinion.

**5.5 File inspection**

The file of a request for a technical opinion is not a file within the meaning of Art. 128 and is not available for file inspection.

**5.6 Appearance before the national court**

If, after the opinion is issued, the national court asks the Examining Division to appear before it, the court should be informed that the EPO is willing to send one member of the Division provided that his costs are paid and on the understanding that this member will be required only to answer questions on the technical opinion given and will not be required to give an opinion on additional matters unless notice in writing of these additional matters is given to the Examining Division at least one month before the appearance before the court.

## Chapter XII – Registration of changes of name, transfers, licences and other rights

### 1. General

Pursuant to Rules 22 to 24 in conjunction with Rule 143(1)(w), rights and transfer of such rights relating to an application or a European patent are registered in the European Patent Register.

Changes of name are recorded as particulars of the applicant in accordance with Rule 143(1)(f).

### 2. Responsible department

The Legal Division of the EPO bears the sole responsibility for these registrations (Decision of the President of the EPO dated 21 November 2013, OJ EPO 2013, 600).

*Art. 20*

The Legal Division may entrust specific duties which do not require legal expertise to formalities officers (Decision of the President of the EPO dated 21 November 2013, OJ EPO 2013, 601).

### 3. Transfer of the European patent application

A European patent application may be transferred for one or more of the designated contracting states.

*Art. 71*

Art. 72 is an autonomous provision which exclusively governs the formal requirements of such transfers. The EPO registers a transfer of rights in the European Patent Register on request, upon fulfilment of the prerequisites of Rule 22. The request is not deemed to have been filed until an administrative fee has been paid. The amount of the fee is determined by the latest schedule of fees and expenses of the EPO.

*Art. 72*

*Rule 22(1) and (2)*

Rule 22 furthermore requires the production of documents providing evidence of such a transfer. Any kind of written evidence suitable for proving the transfer is admissible. This includes formal documentary proof such as the instrument of transfer itself (the original or a copy thereof) or other official documents or extracts thereof, provided that they immediately verify the transfer (J 12/00). A declaration of the assignor only is likewise sufficient, provided that the request has been filed by the assignee.

If the evidence presented is found to be unsatisfactory, the EPO informs the party requesting the transfer accordingly, and invites it to remedy the stated deficiencies within a given time limit.

If the request complies with the requirements of Rule 22(1), the transfer is registered with the date on which the request, the required evidence or the fee has been received by the EPO, whichever is the latest.

*Rule 22(3)* On the above date, the transfer becomes effective vis-à-vis the EPO, i.e. from that date the newly registered applicant is entitled to exercise the right to the European patent application in proceedings before the EPO (Art. 60(3)). If the transfer was for certain designated states only, Art. 118 applies.

*Art. 20* In cases where the transfer is later challenged by the originally registered applicant, e.g. due to the accusation of falsified documentary evidence or an adverse situation of national civil law, the original status quo of the European Patent Register is restored until the valid legal situation has been proven, e.g. by means of a national judicial decision.

*Rule 85* **4. Transfer of the European patent**  
Rule 22 applies *mutatis mutandis* to the registration of a transfer of the European patent during the opposition period or during opposition proceedings.

#### **5. Changes of name**

Mere changes of name, which do not involve a modification of the legal identity of the applicant, are registered in the European Patent Register upon request and production of relevant documentary evidence. Such registration is free of charge.

#### **6. Licences and other rights**

##### **6.1 Registration**

*Art. 71*  
*Art. 73*  
*Rule 23(1)*  
*Rule 24(a) and (b)* A European patent application may give rise to rights *in rem*, may be licensed and may be the subject of legal means of execution. This includes contractual licences only (Art. 73). The licence may be geographically limited to parts of the territories of the designated Contracting States only.

In the case of co-applicants, the respective registration requires the consent of each of the co-applicants.

Rule 22(1) and (2) apply *mutatis mutandis* to the registration of the grant, establishment or transfer of such rights (see E-XII, 3).

A licence will be recorded in the European Patent Register as an exclusive licence if the applicant and the licensee so require. A licence will be recorded as a sub-licence where it is granted by a licensee whose licence is recorded in the European Patent Register.

##### **6.2 Cancellation of licences**

*Rule 22(2)*  
*Rule 23(2)* A registration of licences or other rights is cancelled upon request, supported by documents providing evidence that the right has lapsed or by the written consent of the proprietor of the right to the cancellation of that right. Rule 22(2) applies *mutatis mutandis*, i.e. the cancellation is subject to the payment of an administrative fee.

# **Part F**

## **The European Patent Application**



# Contents

## **Chapter I – Introduction I-1**

## **Chapter II – Content of a European patent application (other than claims) II-1**

<b>1. General</b>	<b>II-1</b>
<b>2. Abstract</b>	<b>II-1</b>
2.1 Purpose of the abstract	II-1
2.2 Definitive content	II-1
2.3 Content of the abstract	II-2
2.4 Figure accompanying the abstract	II-2
2.5 Checklist	II-2
2.6 Transmittal of the abstract to the applicant	II-3
2.7 Abstract in examination	II-3
<b>3. Request for grant – the title</b>	<b>II-3</b>
<b>4. Description (formal requirements)</b>	<b>II-3</b>
4.1 General remarks	II-3
4.2 Technical field	II-4
4.3 Background art	II-4
4.3.1 Format of background art citations	II-5
4.3.1.1 Examples of quotation for non-patent literature	II-6
4.3.1.2 Examples of quotation for patent literature	II-6
4.4 Irrelevant matter	II-7
4.5 Technical problem and its solution	II-7
4.6 Rule 42(1)(c) vs. Art. 52(1)	II-7
4.7 Reference in the description to drawings	II-8
4.8 Reference signs	II-8
4.9 Industrial application	II-8
4.10 Manner and order of presentation	II-8

---

4.11	Terminology	II-9
4.12	Computer programs	II-9
4.13	Physical values, units	II-9
4.14	Registered trademarks	II-10
<b>5.</b>	<b>Drawings</b>	<b>II-10</b>
5.1	Form and content	II-10
5.2	Printing quality	II-10
5.3	Photographs	II-10
<b>6.</b>	<b>Sequence listings</b>	<b>II-10</b>
6.1	Reference to sequences disclosed in a database	II-11
<b>7.</b>	<b>Prohibited matter</b>	<b>II-11</b>
7.1	Categories	II-11
7.2	Matter contrary to "ordre public" or morality	II-11
7.3	Disparaging statements	II-12
7.4	Irrelevant matter	II-12
7.5	Omission of matter from publication	II-12
<b>Annex 1</b>	<b>Checklist for considering the abstract (see F-II, 2.5)</b>	<b>II-13</b>
<b>Annex 2</b>	<b>Units recognised in international practice and complying with Rule 49(10) (see F-II, 4.13)</b>	<b>II-14</b>
	<b>Chapter III – Sufficiency of disclosure</b>	<b>III-1</b>
<b>1.</b>	<b>Sufficiency of disclosure</b>	<b>III-1</b>
<b>2.</b>	<b>Art. 83 vs. Art. 123(2)</b>	<b>III-2</b>
<b>3.</b>	<b>Insufficient disclosure</b>	<b>III-2</b>
<b>4.</b>	<b>Burden of proof as regards the possibility of performing and repeating the invention</b>	<b>III-3</b>



<b>5.</b>	<b>Cases of partially insufficient disclosure</b>	<b>III-3</b>
5.1	Only variants of the invention are incapable of being performed	III-3
5.2	Absence of well-known details	III-3
5.3	Difficulties in performing the invention	III-3
<b>6.</b>	<b>Inventions relating to biological material</b>	<b>III-4</b>
6.1	Biological material	III-4
6.2	Public availability of biological material	III-4
6.3	Deposit of biological material	III-5
6.4	Priority claim	III-7
6.5	Euro-PCT cases	III-7
<b>7.</b>	<b>Proper names, trademarks and trade names</b>	<b>III-7</b>
<b>8.</b>	<b>Reference documents</b>	<b>III-8</b>
<b>9.</b>	<b>"Reach-through" claims</b>	<b>III-9</b>
<b>10.</b>	<b>Sufficiency of disclosure and Rule 56</b>	<b>III-10</b>
<b>11.</b>	<b>Sufficiency of disclosure and clarity</b>	<b>III-10</b>
<b>12.</b>	<b>Sufficiency of disclosure and inventive step</b>	<b>III-10</b>

## **Chapter IV – Claims (Art. 84 and formal requirements)** **IV-1**

<b>1.</b>	<b>General</b>	<b>IV-1</b>
<b>2.</b>	<b>Form and content of claims</b>	<b>IV-1</b>
2.1	Technical features	IV-1
2.2	Two-part form	IV-1
2.3	Two-part form unsuitable	IV-2
2.3.1	No two-part form	IV-3
2.3.2	Two-part form "wherever appropriate"	IV-3
2.4	Formulae and tables	IV-3

---

<b>3.</b>	<b>Kinds of claim</b>	<b>IV-3</b>
3.1	Categories	IV-3
3.2	Number of independent claims	IV-4
3.3	Objection under Rule 43(2) or Rule 137(5)	IV-6
3.4	Independent and dependent claims	IV-7
3.5	Arrangement of claims	IV-8
3.6	Subject-matter of a dependent claim	IV-8
3.7	Alternatives in a claim	IV-8
3.8	Independent claims containing a reference to another claim or to features from a claim of another category	IV-8
<b>4.</b>	<b>Clarity and interpretation of claims</b>	<b>IV-9</b>
4.1	Clarity	IV-9
4.2	Interpretation	IV-10
4.3	Inconsistencies	IV-10
4.4	General statements, "spirit" of invention	IV-11
4.5	Essential features	IV-11
4.5.1	Objections arising from missing essential features	IV-11
4.5.2	Definition of essential features	IV-12
4.5.3	Generalisation of essential features	IV-12
4.5.4	Implicit features	IV-12
4.5.5	Examples	IV-13
4.6	Relative terms	IV-13
4.7	Terms like "about" and "approximately"	IV-13
4.8	Trademarks	IV-13
4.9	Optional features	IV-14
4.10	Result to be achieved	IV-14
4.11	Parameters	IV-14
4.12	Product-by-process claim	IV-15
4.13	"Apparatus for ...", "Method for ...", etc.	IV-16
4.14	Definition by reference to use or another entity	IV-17

---

4.15	The expression "in"	IV-18
4.16	Use claims	IV-18
4.17	References to the description or drawings	IV-19
4.18	Method of and means for measuring parameters referred to in claims	IV-20
4.19	Reference signs	IV-20
4.20	Negative limitations (e.g. disclaimers)	IV-21
4.21	"Comprising" vs. "consisting"	IV-21
4.22	Functional definition of a pathological condition	IV-22
4.23	Broad claims	IV-22
4.24	Order of claims	IV-22
<b>5.</b>	<b>Conciseness, number of claims</b>	<b>IV-23</b>
<b>6.</b>	<b>Support in description</b>	<b>IV-23</b>
6.1	General remarks	IV-23
6.2	Extent of generalisation	IV-23
6.3	Objection of lack of support	IV-24
6.4	Lack of support vs. insufficient disclosure	IV-25
6.5	Definition in terms of function	IV-26
6.6	Support for dependent claims	IV-26
<b>Annex</b>	<b>Examples concerning essential features</b>	<b>IV-27</b>
<b>Chapter V – Unity of invention</b>		<b>V-1</b>
<b>1.</b>	<b>General remarks</b>	<b>V-1</b>
<b>2.</b>	<b>Special technical features</b>	<b>V-1</b>
<b>3.</b>	<b>Intermediate and final products</b>	<b>V-3</b>
<b>4.</b>	<b>Alternatives</b>	<b>V-4</b>
<b>5.</b>	<b>Markush grouping</b>	<b>V-4</b>
<b>6.</b>	<b>Individual features in a claim</b>	<b>V-5</b>

---

<b>7.</b>	<b>Lack of unity "<i>a priori</i>" or "<i>a posteriori</i>"</b>	<b>V-5</b>
<b>8.</b>	<b>Examiner's approach</b>	<b>V-5</b>
8.1	Reasoning for a lack of unity objection	V-6
8.2	Determination of the invention first mentioned in the claims	V-6
<b>9.</b>	<b>Dependent claims</b>	<b>V-6</b>
<b>10.</b>	<b>Lack of unity during search</b>	<b>V-7</b>
<b>11.</b>	<b>Lack of unity during substantive examination</b>	<b>V-7</b>
11.1	General principles	V-7
11.2	Objections to unsearched inventions	V-7
11.3	Review of non-unity findings	V-7
<b>12.</b>	<b>Amended claims</b>	<b>V-8</b>
<b>13.</b>	<b>Euro-PCT applications</b>	<b>V-8</b>
13.1	International applications without supplementary search	V-8
13.2	International applications with supplementary search	V-9
13.3	International preliminary examination report (IPER)	V-9
13.4	Restricted IPER	V-9
<b>14.</b>	<b>Relationship between Rule 43(2) and Art. 82</b>	<b>V-10</b>
<b>Chapter VI – Priority</b>		<b>VI-1</b>
<b>1.</b>	<b>The right to priority</b>	<b>VI-1</b>
1.1	Filing date as effective date	VI-1
1.2	Priority date as effective date	VI-1
1.3	Validly claiming priority	VI-1
1.4	First application	VI-2

---

1.4.1	Subsequent application considered as first application	VI-2
1.5	Multiple priorities	VI-4
<b>2.</b>	<b>Determining priority dates</b>	<b>VI-4</b>
2.1	Examining the validity of a right to priority	VI-4
2.2	The same invention	VI-5
2.3	Priority claim not valid	VI-6
2.4	Some examples of determining priority dates	VI-6
2.4.1	Intermediate publication of the contents of the priority application	VI-6
2.4.2	Intermediate publication of another European application	VI-7
2.4.3	Multiple priorities claimed for different inventions in the application with an intermediate publication of one of the inventions	VI-7
2.4.4	A situation in which it has to be checked whether the application from which priority is actually claimed is the "first application" in the sense of Art. 87(1)	VI-7
<b>3.</b>	<b>Claiming priority</b>	<b>VI-8</b>
3.1	General remarks	VI-8
3.2	Declaration of priority	VI-8
3.3	Certified copy of the previous application (priority document)	VI-8
3.4	Translation of the previous application	VI-9
3.5	Abandonment of priority claim	VI-10
3.6	Re-establishment of rights in respect of the priority period	VI-10



## Chapter I – Introduction

Apart from the requirements of patentability (novelty, inventive step, industrial application and exclusions from patentability), a European patent application must also satisfy a number of other requirements. These include substantive requirements such as sufficiency of disclosure (Art. 83), clarity of the claims (Art. 84) and unity of invention (Art. 82) as well as requirements of a more formal nature such as the numbering of the claims (Rule 43(5)) and the form of the drawings (Rule 46). These requirements are dealt with in the present Part F.

Part F also deals with the requirements relating to the right to priority. This is because, despite the fact that this issue is usually assessed only when it has a potential bearing on a question of patentability (see G-IV, 3), it is nonetheless assessed independently of any issues of patentability.





## Chapter II – Content of a European patent application (other than claims)

### 1. General

The requirements for a European patent application are set out in Art. 78. The application must contain: *Art. 78*

- (i) a request for the grant of a European patent; *Art. 78(1)(a)*
- (ii) a description of the invention; *Art. 78(1)(b)*
- (iii) one or more claims; *Art. 78(1)(c)*
- (iv) any drawings referred to in the description or the claims; and *Art. 78(1)(d)*
- (v) an abstract. *Art. 78(1)(e)*

This Chapter deals with all these requirements, insofar as they are the concern of the examiner, with the exception of item (iii) which is the subject of Chapter F-IV. Item (v) is dealt with first.

### 2. Abstract

#### 2.1 Purpose of the abstract

The application must contain an abstract. The purpose of the abstract is to give brief technical information about the disclosure as contained in the description, claims and any drawings. *Rule 57(d)*  
*Rule 47(5)*

#### 2.2 Definitive content

The abstract is initially supplied by the applicant. The examiner has the task of determining its definitive content, which will normally be published with the application. In doing this, he should consider the abstract in relation to the application as filed (see B-X, 7(i)). If the search report is published later than the application, the abstract, published with the application will be the one resulting from the examination referred to in B-X, 7(i), third sentence. *Rule 66*  
*Rule 68*

In determining the definitive content, the examiner should take into consideration that the abstract is merely for use as technical information and in particular must not be used for the purpose of interpreting the scope of the protection sought. The abstract should be so drafted that it constitutes an efficient instrument for purposes of searching in the particular technical field and should in particular make it possible to assess whether there is need for consulting the European patent application itself. *Art. 85*  
*Rule 47(5)*

### 2.3 Content of the abstract

The abstract must:

- Rule 47(1)* (i) indicate the title of the invention
- Rule 47(2)* (ii) indicate the technical field to which the invention pertains;
- Rule 47(2)* (iii) contain a concise summary of the disclosure as contained in the description, claims and drawings, which must be so drafted as to allow a clear understanding of the technical problem, the gist of the solution of that problem through the invention and the principal use of the invention and, where applicable, it should contain the chemical formula which, among those contained in the application, best characterises the invention;
- Rule 47(2)* (iv) **not** contain statements on the alleged merits or value of the invention or its speculative application;
- Rule 47(3)* (v) preferably not contain more than one hundred and fifty words; and
- Rule 47(4)* (vi) be accompanied by an indication of the figure or exceptionally more than one figure of the drawings which should accompany the abstract. Each main feature mentioned in the abstract and illustrated by a drawing, should be followed by a reference sign in parenthesis.

### 2.4 Figure accompanying the abstract

- Rule 47(4)* The examiner should consider not only the text of the abstract but also the selection of the figures for publication with it. He should alter the text to the extent that this may be necessary in order to meet the requirements set out in F-II, 2.3. He will select a different figure, or figures, of the drawings if he considers that they better characterise the inventions.

The examiner may prevent the publication of any drawing with the abstract, where none of the drawings present in the application is useful for the understanding of the abstract. This can be done even when the applicant has requested that a particular drawing or drawings be published with the abstract according to Rule 47(4).

In determining the content of the abstract, the examiner should concentrate on conciseness and clarity, and refrain from introducing alterations merely for the purpose of embellishing the language (see B-X, 7).

### 2.5 Checklist

In considering the abstract, the examiner should check it against the General Guidelines for the Preparation of Abstracts of Patent Documents, using the checklist contained WIPO Standard ST.12, the relevant parts of which are annexed to this Chapter (F-II, Annex 1).

## 2.6 Transmittal of the abstract to the applicant

The content of the abstract is transmitted to the applicant together with the search report (see B-X, 7(i)). *Rule 66*

## 2.7 Abstract in examination

The general considerations relating to the abstract are set out in F-II, 2.1 to 2.6. The abstract relates to the application as filed and published and its final form for publication is determined by the Search Division. It is not necessary to bring it into conformity with the content of the published patent even if this should differ in substance from that of the application, since the patent specification does not contain an abstract. The examiner should therefore not seek any amendment of the abstract. He should, however, note that the abstract has no legal effect on the application containing it; for instance, it cannot be used to interpret the scope of protection or to justify the addition to the description of new subject-matter. *Art. 85*  
*Art. 98*

## 3. Request for grant – the title

The items making up this request are dealt with in A-III, 4. They do not normally concern the examiner, with the exception of the title.

The title should clearly and concisely state the technical designation of the invention and should exclude all fancy names (see A-III, 7.1). While any obvious failures to meet these requirements are likely to be noted during the formalities examination (and possibly during the search, see B-X, 7(ii)), the examiner should review the title in the light of his reading of the description and claims and any amendments thereto, to make sure that the title, as well as being concise, gives a clear and adequate indication of the subject of the invention. Thus, if amendments are made which change the categories of claims, the examiner should check whether a corresponding amendment is needed in the title. *Rule 41(2)(b)*

## 4. Description (formal requirements)

### 4.1 General remarks

The application must disclose the invention in a manner sufficiently clear and complete for it to be carried out by a person skilled in the art. *Art. 83*  
*Rule 42*

The "person skilled in the art" for this purpose is considered to be the skilled practitioner in the relevant field aware not only of the teaching of the application itself and the references therein, but also of what was common general knowledge in the art at the date of filing the application. He is assumed to have had at his disposal the means and the capacity for routine work and experimentation, which are normal for the technical field in question. As "common general knowledge" can generally be considered the information contained in basic handbooks, monographs and textbooks on the subject in question (see T 171/84). As an exception, it can also be the information contained in patent specifications or scientific publications, if the invention lies in a field of research which is so new that the relevant technical knowledge is not yet available from textbooks (see T 51/87). Sufficiency of disclosure

must be assessed on the basis of the application as a whole, including the description, claims and drawings, if any. The provisions relating to the content of the description are set out in Rule 42. The purpose of the provisions of Art. 83 and Rule 42 is:

- (i) to ensure that the application contains sufficient technical information to enable a skilled person to put the invention as claimed into practice; and
- (ii) to enable the reader to understand the contribution to the art which the invention as claimed has made.

#### **4.2 Technical field**

*Rule 42(1)(a)*

The invention should be placed in its setting by specifying the technical field to which it relates.

#### **4.3 Background art**

*Rule 42(1)(b)*  
*Art. 123(2)*

The description should also mention any background art of which the applicant is aware, and which can be regarded as useful for understanding the invention and its relationship to the prior art; identification of documents reflecting such art, especially patent specifications, should preferably be included. This applies in particular to the background art corresponding to the first or "prior art" portion of the independent claim or claims (see F-IV, 2.2).

In principle, when filing an application the applicant should cite in the description the closest prior art known to him. It may happen that the prior art cited by the applicant is not the closest existing for the claimed invention. Therefore, the documents cited in the application as filed do not necessarily describe the known innovations closest to the claimed invention, but may in fact constitute more distantly related prior art.

The insertion into the statement of prior art of references to documents identified subsequently, for example by the search report, should be required, where necessary, to put the invention into proper perspective (see T 11/82). For instance, while the originally filed description of prior art may give the impression that the inventor has developed the invention from a certain point, the cited documents may show that certain stages in, or aspects of, this alleged development were already known. In such a case the examiner should require a reference to these documents and a brief summary of the relevant contents. The subsequent inclusion of such a summary in the description does not contravene Art. 123(2). The latter merely lays down that, if the application is amended, for example by limiting it in the light of additional information on the background art, its subject-matter must not extend beyond the content of the application as filed. But the subject-matter of the European patent application within the meaning of Art. 123(2) is to be understood – starting off from the prior art – as comprising those features which, in the framework of the disclosure required by Art. 83, relate to the invention (see also H-IV, 2.1). In addition, relevant prior art documents not cited in the original

application may be subsequently acknowledged in the description even if these were known to the applicant at the time of filing (T 2321/08 and H-IV, 2.3.7).

References to the prior art introduced after filing must be purely factual. Any alleged advantages of the invention must be adjusted if necessary in the light of the prior art.

New statements of advantage are permissible provided that they do not introduce into the description matter which could not have been deduced from the application as originally filed (see H-V, 2.2).

The applicant may cite documents in the application which relate to standard technical knowledge (background art neither addressing the same technical problem nor necessary to complete the disclosure of the claimed invention). Such citations typically relate to well-known tests for measuring certain parameters mentioned in the description or to the definitions of terms of established meaning that are used in the application. Usually they are not relevant for assessing the patentability of the claimed invention, unless for example they contain relevant information which the applicant does not mention in the description.

Acknowledgment of prior art relevant to the dependent claims only is generally not required. If the applicant indicates that subject-matter initially cited as prior art is only "in-house state of the art", such prior art may not be used in the assessment of novelty and inventive step. However, it may be allowed to remain in the description, provided the fact that it is only "in-house state of the art" is made clear.

If the relevant prior art consists of another European patent application falling within the terms of Art. 54(3), this relevant prior document belongs to the state of the art for all Contracting States. This is the case even if the two applications do not share any commonly designated State, or the designation of commonly designated States has been dropped (see G-IV, 6). The fact that this document falls under Art. 54(3) must be explicitly acknowledged. Thus the public is informed that the document is not relevant to the question of inventive step (see G-VII, 2). According to Rule 165, the above also applies to international applications designating EP, for which the filing fee pursuant to Rule 159(1)(c) has been validly paid and, where applicable, the translation into one of the official languages has been filed (Art. 153(3) and (4)) (see G-IV, 5.2). *Art. 54(3)*

For transitional provisions concerning the applicability of Art. 54(4) EPC 1973, see H-III, 4.2. *Art. 54(4) EPC 1973*

#### **4.3.1 Format of background art citations**

In citing documents or inserting references, applicants and examiners alike should use codes that allow the references to be retrieved without

difficulty. This can be best achieved through consistent use of the WIPO Standards format:

- (i) for non-patent literature, WIPO Standard ST.14 (Recommendation for the Inclusion of References Cited in Patent Documents);
- (ii) for patent literature (applications, granted patents and utility models): for the two-letter country code, WIPO Standard ST.3 (Recommended Standard on Two-Letter Codes for the Representation of States, Other Entities and Intergovernmental Organizations); for symbols indicating the type of document, WIPO Standard ST.16 (Recommended Standard Code for the Identification of Different Kinds of Patent Documents).

WIPO Standards ST.14, ST.3 and ST.16 can be found on the WIPO website.

However, in case of deviation from these standards there is no need to correct the codes used, as long as straightforward retrieval of the citation(s) is possible.

#### **4.3.1.1 Examples of quotation for non-patent literature**

- (i) For a monograph:

WALTON Herrmann, Microwave Quantum Theory. London: Sweet and Maxwell, 1973, Vol. 2, pages 138 to 192.

- (ii) For an article in a periodical:

DROP, J.G. Integrated Circuit Personalization at the Module Level. IBM tech. dis. bull. October 1974, Vol. 17, No. 5, pages 1344 and 1345.

- (iii) For a separately published abstract:

Chem. abstr., Vol. 75, No. 20, 15 November 1971 (Columbus, Ohio, USA), page 16, column 1, abstract No. 120718k, SHETULOV, D.I. 'Surface Effects During Metal Fatigue,' Fiz.-Him. Meh. Mater. 1971, 7(29), 7-11 (Russ.).

Patent Abstracts of Japan, Vol. 15, No. 105 (M-1092), 13 March 1991, JP 30 02404 A (FUDDO).

#### **4.3.1.2 Examples of quotation for patent literature**

- (i) JP 50-14535 B (NCR CORP.) 28 May 1975 (28.05.75), column 4, lines 3 to 27.
- (ii) DE 3744403 A1 (A. JOSEK) 29.08.1991, page 1, abstract.

#### 4.4 Irrelevant matter

Since the reader is presumed to have the general technical background knowledge appropriate to the art, the examiner should not require the applicant to insert anything in the nature of a treatise or research report or explanatory matter which is obtainable from textbooks or is otherwise well-known. Likewise the examiner should not require a detailed description of the content of cited prior documents. It is sufficient that the reason for the inclusion of the reference is indicated, unless in a particular case a more detailed description is necessary for a full understanding of the invention of the application (see also F-III, 8 and F-IV, 2.3.1).

*Rule 48(1)(c)*

A list of several reference documents relating to the same feature or aspect of the prior art is not required; only the most appropriate need be referred to. On the other hand, the examiner should not insist upon the excision of any such unnecessary matter, except when it is very extensive (see F-II, 7.4).

#### 4.5 Technical problem and its solution

The invention as claimed should be disclosed in such a way that the technical problem, or problems, with which it deals can be appreciated and the solution can be understood. To meet this requirement, only such details should be included as are necessary for elucidating the invention.

*Rule 42(1)(c)*

*Rule 48(1)(b)*

In cases where the subject-matter of a dependent claim can be understood either by the wording of the claim itself or by the description of a way of performing the invention, no additional explanation of this subject-matter will be necessary. A mention in the description that a particular embodiment of the invention is set out in the dependent claim will then be sufficient.

When there is doubt, however, as to whether certain details are necessary, the examiner should not insist on their excision. It is not necessary, moreover, that the invention be presented explicitly in problem-and-solution form. Any advantageous effects which the applicant considers the invention to have in relation to the prior art should be stated, but this should not be done in such a way as to disparage any particular prior product or process. Furthermore, neither the prior art nor the applicant's invention should be referred to in a manner likely to mislead. This might be done e.g. by an ambiguous presentation which gives the impression that the prior art had solved less of the problem than was actually the case. Fair comment as referred to in F-II, 7.3 is, however, permitted. Regarding amendment to, or addition of, a statement of problem, see H-V, 2.4.

#### 4.6 Rule 42(1)(c) vs. Art. 52(1)

If it is decided that an independent claim defines a patentable invention within the meaning of Art. 52(1), it must be possible to derive a technical problem from the application. In this case the requirement of Rule 42(1)(c) is fulfilled (see T 26/81).

*Rule 42(1)(c)*

#### 4.7 Reference in the description to drawings

*Rule 42(1)(d)*

If drawings are included they should first be briefly described, in a manner such as: "Figure 1 is a plan view of the transformer housing; Figure 2 is a side elevation of the housing; Figure 3 is an end elevation looking in the direction of the arrow X of Figure 2; Figure 4 is a cross-section taken through AA of Figure 1." When it is necessary to refer in the description to elements of the drawings, the name of the element should be referred to as well as its number, i.e. the reference should not be in the form: "3 is connected to 5 via 4" but, "resistor 3 is connected to capacitor 5 via switch 4".

#### 4.8 Reference signs

*Rule 46(2)(i)*

The description and drawings should be consistent with one another, especially in the matter of reference numbers and other signs, and each number or sign must be explained. However, where as a result of amendments to the description whole passages are deleted, it may be tedious to delete all superfluous references from the drawings and in such a case the examiner should not pursue an objection under Rule 46(2)(i), as to consistency, too rigorously. The reverse situation should never occur, i.e. all reference numbers or signs used in the description or claims must also appear on the drawings.

#### 4.9 Industrial application

*Rule 42(1)(f)*

*Art. 52(1)*

*Art. 57*

The description should indicate explicitly the way in which the invention is capable of exploitation in industry, if this is not obvious from the description or from the nature of the invention. The expression "capable of exploitation in industry" means the same as "susceptible of industrial application", and indeed identical expressions are used in the French and German texts of the EPC. In view of the broad meaning given to the latter expression by Art. 57 (see G-III, 1), it is to be expected that, in most cases, the way in which the invention can be exploited in industry will be self-evident, so that no more explicit description on this point will be required; but there may be a few instances, e.g. in relation to methods of testing, where the manner of industrial exploitation is not apparent and must therefore be explicitly indicated.

*Rule 29(3)*

Also, in relation to certain biotechnological inventions, i.e. sequences and partial sequences of genes, the industrial application is not self-evident. The industrial application of such sequences must be disclosed in the patent application (see G-III, 4).

#### 4.10 Manner and order of presentation

*Rule 42(2)*

The manner and order of presentation of the description should be that specified in Rule 42(1), i.e. as set out above, unless, because of the nature of the invention, a different manner or a different order would afford a better understanding and a more economic presentation. Since the responsibility for clearly and completely describing the invention lies with the applicant, the examiner should not object to the presentation unless satisfied that such an objection would be a proper exercise of his discretion.



Some departure from the requirements of Rule 42(1) is acceptable, provided the description is clear and orderly and all the requisite information is present. For example, the requirements of Rule 42(1)(c) may be waived where the invention is based on a fortuitous discovery, the practical application of which is recognised as being useful, or where the invention breaks entirely new ground. Also, certain technically simple inventions may be fully comprehensible with the minimum of description and only slight reference to prior art.

#### **4.11 Terminology**

Although the description should be clear and straightforward with avoidance of unnecessary technical jargon, the use of recognised terms of art is acceptable, and will often be desirable. Little-known or specially-formulated technical terms may be allowed provided that they are adequately defined and that there is no generally recognised equivalent. This discretion may be extended to foreign terms when there is no equivalent in the language of the proceedings. Terms already having an established meaning should not be allowed to be used to mean something different if this is likely to cause confusion. There may, however, be circumstances where a term may legitimately be borrowed from an analogous art. Terminology and signs must be consistent throughout the application.

*Rule 49(11)*

#### **4.12 Computer programs**

In the particular case of inventions in the computer field, program listings in programming languages cannot be relied on as the sole disclosure of the invention. The description, as in other technical fields, should be written substantially in normal language, possibly accompanied by flow diagrams or other aids to understanding, so that the invention may be understood by a person skilled in the art who is deemed not to be a specialist in any specific programming language, but does have general programming skills. Short excerpts from programs written in commonly used programming languages can be accepted if they serve to illustrate an embodiment of the invention.

#### **4.13 Physical values, units**

When the properties of a material are referred to, the relevant units should be specified if quantitative considerations are involved. If this is done by reference to a published standard (e.g. a standard of sieve sizes) and such standard is referred to by a set of initials or similar abbreviation, it should be adequately identified in the description.

Physical values must be expressed in the units recognised in international practice, which is generally in the metric system, using SI units and the other units referred to in Chapter I of the Annex to EEC Directive 80/181/EEC of 20 December 1979, as amended by EEC Directives 85/1/EEC of 18 December 1984, 89/617/EEC of 27 November 1989, 1999/103/EC of 24 January 2000 and 2009/3/EC of 11 March 2009 (see F-II, Annex 2). Any values not meeting this requirement must also be expressed in the units recognised in international practice. Values expressed in the system of imperial units

*Rule 49(10)*

(e.g. inches/pounds) or in units having local character (e.g. pint), in general, do not meet the criterion "recognised in international practice".

As Rule 49(10) indicates, for mathematical formulae the symbols in general use must be employed. For chemical formulae, the symbols, atomic weights and molecular formulae in general use must be employed.

In general, use should be made of the technical terms, signs and symbols generally accepted in the field in question.

#### **4.14 Registered trademarks**

It is the applicant's responsibility to ensure that registered trademarks are acknowledged as such in the description. For the assessment of the clarity of claims referring to a trademark (Art. 84), see F-IV, 4.8. With regard to the effect of references to trademarks on sufficiency of disclosure (Art. 83), see F-III, 7.

### **5. Drawings**

#### **5.1 Form and content**

The requirements relating to the form and content of drawings are set down in Rule 46. Most of these are formal (see A-IX), but the examiner may sometimes need to consider the requirements of Rule 46(2)(f), (h), (i) and (j). Of these, the only question likely to cause difficulty is whether the textual matter included on the drawings is absolutely indispensable. In the case of circuit diagrams, block schematics and flow sheets, identifying catchwords for functional integers of complex systems (e.g. "magnetic core store", "speed integrator") may be regarded as indispensable from a practical point of view if they are necessary to enable a diagram to be interpreted rapidly and clearly.

#### **5.2 Printing quality**

The examiner has also to check whether the drawings in the printing copy ("Druckexemplar") are suitable for printing. If necessary, a copy of the original drawings must be prepared as the printing copy. If, however, the quality of the original drawings is also insufficient, then the examiner must request the applicant to present drawings of sufficient quality for printing. He should, however, beware of any extension of subject-matter (Art. 123(2)).

#### **5.3 Photographs**

For the presentation of photographs, see A-IX, 1.2. In case of photographs of insufficient original quality for printing, the examiner should not request filing of better photographs, as the risk of infringing Art. 123(2) is obvious. In that case, the insufficient quality is accepted for reproduction.

### **6. Sequence listings**

For the presentation of sequence listings in general, see A-IV, 5.

*Rule 46*

*Rule 46(2)(j)*

## 6.1 Reference to sequences disclosed in a database

The application may refer to a biological sequence belonging to the state of the art by merely providing the sequence's accession number and its version or release number in a publicly available database, without presenting the sequence itself either in a sequence listing complying with WIPO Standard ST.25 or in any other format.

Since in this case the sequence is already publicly available, the applicant does not need to supply a sequence listing. This applies even if reference is made to these sequences in one or more claims or if the sequences are essential features of the invention or necessary for the prior-art search (see J 8/11). If the European patent application discloses nucleotide or amino acid sequences that are fragments or variants of a prior-art sequence, a sequence listing complying with WIPO Standard ST.25 has to be filed for these sequence fragments or variants (see Notice from the EPO concerning the filing of sequence listings dated 18 October 2013, OJ EPO 2013, 542, I.1.5). If the database and/or the sequences in question is/are not completely and unambiguously identified, the sequences are not sufficiently disclosed according to Art. 83 and cannot be added to the application to complete the disclosure without contravening Art. 123(2) (see F-III, 2).

If such insufficiently disclosed sequences are not essential features of the claimed invention, the examiner will normally raise no objection. On the other hand, where these sequences are essential features of at least a part of the claimed subject-matter, this results in problems relating to the sufficiency of the original disclosure according to Art. 83 because the nature of the sequences cannot be unambiguously derived from the incomplete or ambiguous reference to the database.

Examples where a biological sequence is considered an essential feature of the invention would be a diagnostic method using a particular nucleic acid sequence or a product made by a biochemical process using an enzyme with a particular amino acid sequence. An example of ambiguous identification would be the citation of an accession number of a certain protein in the database of the European Molecular Biology Laboratory EMBL with no indication of which version number or database release number is meant when there are several such numbers referring to different sequences of the protein.

## 7. Prohibited matter

### 7.1 Categories

There are three categories of specifically prohibited matter, these being defined in sub-paragraphs (a) to (c) of Rule 48(1) (see also G-II, 4).

*Rule 48*

### 7.2 Matter contrary to "ordre public" or morality

It should be noted that the omission, from the publication of the application, is mandatory for the first category. Examples of the kind of matter coming within this category are: incitement to riot or to acts of

*Rule 48(1)(a)*

disorder; incitement to criminal acts; racial, religious or similar discriminatory propaganda; and grossly obscene matter.

With regard to patentability issues with such matter, see G-II, 4.1 and subsections.

### **7.3 Disparaging statements**

*Rule 48(1)(b)*

It is necessary to discriminate in the second category between libellous or similarly disparaging statements, which are not allowed, and fair comment, e.g. in relation to obvious or generally recognised disadvantages, or disadvantages stated to have been found and substantiated by the applicant, which, if relevant, is permitted.

### **7.4 Irrelevant matter**

*Rule 48(1)(c)*

The third category is irrelevant matter. It should be noted, however, that such matter is specifically prohibited under Rule 48(1)(c) only if it is "obviously irrelevant or unnecessary", for instance, if it has no bearing on the subject-matter of the invention or its background of relevant prior art (see also F-II, 4.4). The matter to be removed may already be obviously irrelevant or unnecessary in the original description. It may, however, be matter which has become obviously irrelevant or unnecessary only in the course of the examination proceedings, e.g. owing to a limitation of the claims of the patent to one of originally several alternatives. When matter is removed from the description, it must not be incorporated into the patent specification by reference to the corresponding matter in the published application or in any other document (see also F-III, 8).

### **7.5 Omission of matter from publication**

*Rule 48(2) and (3)*

Generally, the receiving Section will deal with matter falling under category 1(a) and may have dealt with matter obviously falling within category 1(b), but if any such matter has not been so recognised and has therefore not been omitted from the publication of the application, it should be required to be removed during examination of the application together with any other prohibited matter. The applicant should be informed of the category under which matter is required to be removed.

**Annex 1****Checklist for considering the abstract (see F-II, 2.5)**

In the following checklist, the abstractor should, after having studied the disclosure to be abstracted, place a check in the second column after the applicable terms listed in the first column. The requirements listed in the third column corresponding to the checked items of the first column should be borne in mind by the abstractor as he prepares his abstract. Finally, the abstractor may compare his finished abstract with the checked requirements and place a corresponding checkmark in the fourth column if he is satisfied that the requirements have been met.

<b>If the invention is a(n)</b>	<b>Check here</b>	<b>The abstract should deal with:</b>	<b>If so, check here</b>
Article		its identity, use; construction, organization, method of manufacture	
Chemical compound		its identity (structure if appropriate); method of preparation, properties, uses	
Mixture		its nature, properties, use; essential ingredients (identity, function); proportion of ingredients, if significant; preparation	
Machine, apparatus, system		its nature, use; construction, organization; operation	
Process or operation		its nature and characterizing features; material and conditions employed; product, if significant; nature of and relationship between the steps, if more than one	
If the disclosure involves alternatives		the abstract should deal with the preferred alternative and identify the others if this can be done succinctly; if this cannot be done, it should mention that they exist and whether they differ substantially from the preferred alternative	

Total number of words less than 250: ..... in range 50-150: .....

Ref: Standards – ST.12/A, April 1994

Original: Handbook on Industrial Property Information and Documentation, Publication N° 208(E), 1998, WIPO, Geneva (CH).

**Annex 2****Units recognised in international practice and complying with Rule 49(10) (see F-II, 4.13)\*****1. SI units and their decimal multiples and submultiples****1.1 SI base units**

Quantity	Unit	
	Name	Symbol
Length	metre	m
Mass	kilogram	kg
Time	second	s
Electric current	ampere	A
Thermodynamic temperature	kelvin	K
Amount of substance	mole	mol
Luminous intensity	candela	cd

Definitions of SI base units:

– Unit of length

The metre is the length of the path travelled in a vacuum by light during  $1/299792458$  seconds.

– Unit of mass

The kilogram is the unit of mass; it is equal to the mass of the international prototype of the kilogram.

– Unit of time

The second is the duration of 9 192 631 770 periods of the radiation corresponding to the transition between the two hyperfine levels of the ground state of the caesium 133 atom.

– Unit of electric current

The ampere is that constant current which if maintained in two straight parallel conductors of infinite length, of negligible circular cross-section and placed one metre apart in a vacuum, would produce between these conductors a force equal to  $2 \times 10^{-7}$  newton per metre of length.

– Unit of thermodynamic temperature

The kelvin, unit of thermodynamic temperature, is the fraction  $1/273,16$  of the thermodynamic temperature of the triple point of water.

This definition relates to water having the isotopic composition defined by the following amount-of-substance ratios: 0,00015576 mole of  $^2\text{H}$  per mole of  $^1\text{H}$ , 0,0003799 mole of  $^{17}\text{O}$  per mole of  $^{16}\text{O}$  and 0,0020052 mole of  $^{18}\text{O}$  per mole of  $^{16}\text{O}$ .

---

\* Based on Chapter I of the Annex to EEC Directive 80/181/EEC of 20.12.1979, as amended by EEC Directives 85/1/EEC of 18.12.1984, 89/617/EEC of 27.11.1989, 1999/103/EC of 24.01.2000 and 2009/3/EC of 11.03.2009.

– Unit of amount of substance

The mole is the amount of substance of a system which contains as many elementary entities as there are atoms in 0.012 kg of carbon 12. When the mole is used, the elementary entities must be specified and may be atoms, molecules, ions, electrons, other particles or specified groups of such particles.

– Unit of luminous intensity

The candela is the luminous intensity, in a given direction, of a source that emits monochromatic rays with a frequency of  $540 \times 10^{12}$  hertz and that has a radiant intensity in that direction of 1/683 watt per steradian.

### 1.1.1 Special name and symbol of the SI derived unit of temperature for expressing Celsius temperature

Quantity	Unit	
	Name	Symbol
Celsius temperature	degree Celsius	C

Celsius temperature  $t$  is defined as the difference  $t = T - T_0$  between the two thermodynamic temperatures  $T$  and  $T_0$  where  $T_0 = 273.15$  K. An interval of or difference in temperature may be expressed either in kelvins or in degrees Celsius. The unit of 'degree Celsius' is equal to the unit 'kelvin'.

## 1.2 SI derived units

### 1.2.1 General rule for SI derived units

Units derived coherently from SI base units are given as algebraic expressions in the form of products of powers of the SI base units with a numerical factor equal to 1.

### 1.2.2 SI derived units with special names and symbols

Quantity	Unit		Expression	
	Name	Symbol	In other SI units	In terms of SI base units
Plane angle	radian	rad		$m \cdot m^{-1}$
Solid angle	steradian	sr		$m^2 \cdot m^{-2}$
Frequency	hertz	Hz		$s^{-1}$
Force	newton	N		$m \cdot kg \cdot s^{-2}$
Pressure, stress	pascal	Pa	$N \cdot m^{-2}$	$m^{-1} \cdot kg \cdot s^{-2}$
Energy, work; quantity of heat	joule	J	$N \cdot m$	$m^2 \cdot kg \cdot s^{-2}$
Power <sup>(1)</sup> , radiant flux	watt	W	$J \cdot s^{-1}$	$m^2 \cdot kg \cdot s^{-3}$
Quantity of electricity, electric charge	coulomb	C		$s \cdot A$
Electric potential, potential difference, electromotive force	volt	V	$W \cdot A^{-1}$	$m^2 \cdot kg \cdot s^{-3} \cdot A^{-1}$
Electric resistance	ohm	$\Omega$	$V \cdot A^{-1}$	$m^2 \cdot kg \cdot s^{-3} \cdot A^{-2}$
Conductance	siemens	S	$A \cdot V^{-1}$	$m^{-2} \cdot kg^{-1} \cdot s^3 \cdot A^2$

Quantity	Unit		Expression	
	Name	Symbol	In other SI units	In terms of SI base units
Capacitance	farad	F	$C.V^{-1}$	$m^{-2}.kg^{-1}.s^4.A^2$
Magnetic flux	weber	Wb	$V.s$	$m^2.kg.s^{-2}.A^{-1}$
Magnetic flux density	tesla	T	$Wb.m^{-2}$	$kg.s^{-2}.A^{-1}$
Inductance	henry	H	$Wb.A^{-1}$	$m^2.kg.s^{-2}.A^{-2}$
Luminous flux	lumen	lm	cd.sr	cd
Illuminance	lux	lx	$lm.m^{-2}$	$m^{-2}.cd$
Activity (of a radionuclide)	becquerel	Bq		$s^{-1}$
Absorbed dose, specific energy imparted, kerma, absorbed dose index	gray	Gy	$J.kg^{-1}$	$m^2.s^{-2}$
Dose equivalent	sievert	Sv	$J.kg^{-1}$	$m^2.s^{-2}$
Catalytic activity	katal	kat		$mol.s^{-1}$

- (1) Special names for the unit of power: the name volt-ampere (symbol 'VA') is used to express the apparent power of alternating electric current, and var (symbol 'var') is used to express reactive electric power.

Units derived from SI base units may be expressed in terms of the units listed in this annex.

In particular, derived SI units may be expressed by the special names and symbols given in the above table. For example, the SI unit of dynamic viscosity may be expressed as  $m^{-1}.kg.s^{-1}$  or  $N.s.m^{-2}$  or  $Pa.s$ .

### 1.3 Prefixes and their symbols used to designate certain decimal multiples and submultiples

Factor	Prefix	Symbol	Factor	Prefix	Symbol
$10^{24}$	yotta	Y	$10^{-1}$	deci	d
$10^{21}$	zetta	Z	$10^{-2}$	centi	c
$10^{18}$	exa	E	$10^{-3}$	milli	m
$10^{15}$	peta	P	$10^{-6}$	micro	$\mu$
$10^{12}$	tera	T	$10^{-9}$	nano	n
$10^9$	giga	G	$10^{-12}$	pico	p
$10^6$	mega	M	$10^{-15}$	femto	f
$10^3$	kilo	k	$10^{-18}$	atto	a
$10^2$	hecto	h	$10^{-21}$	zepto	z
$10^1$	deca	da	$10^{-24}$	yocto	y

The names and symbols of the decimal multiples and submultiples of the unit of mass are formed by attaching prefixes to the word 'gram' and their symbols to the symbol 'g'.

Where a derived unit is expressed as a fraction, its decimal multiples and submultiples may be designated by attaching a prefix to units in the numerator or the denominator, or in both these parts.



Compound prefixes, that is to say prefixes formed by the juxtaposition of several of the above prefixes, may not be used.

#### 1.4 Special authorised names and symbols of decimal multiples and submultiples of SI units

Quantity	Unit		
	Name	Symbol	Value
Volume	litre	l or L <sup>(1)</sup>	1 l = 1 dm <sup>3</sup> = 10 <sup>-3</sup> m <sup>3</sup>
Mass	tonne	t	1 t = 1 Mg = 10 <sup>3</sup> kg
Pressure, stress	bar	bar	1 bar = 10 <sup>5</sup> Pa

<sup>(1)</sup> The two symbols 'l' and 'L' may be used for the litre unit.

The prefixes and their symbols listed in F-II, Annex 2, 1.3 may be used in conjunction with the units and symbols contained in this table.

#### 2. Units which are defined on the basis of SI units but are not decimal multiples or submultiples thereof

Quantity	Unit		
	Name	Symbol	Value
Plane angle	revolution <sup>(a)</sup>		1 revolution = 2 $\pi$ rad
	grade or gon	gon	1 gon = $\pi / 200$ rad
	degree	°	1° = $\pi / 180$ rad
	minute of angle	'	1' = $\pi / 10\,800$ rad
Time	second of angle	"	1" = $\pi / 648\,000$ rad
	minute	min	1 min = 60 s
	hour	h	1 h = 3 600 s
	day	d	1 d = 86 400 s

<sup>(a)</sup> No international symbol exists

The prefixes listed in F-II, Annex 2, 1.3 may only be used in conjunction with the names 'grade' or 'gon' and the symbols only with the symbol 'gon'.

#### 3. Units used with the SI, and whose values in SI are obtained experimentally

The unified atomic mass unit is 1/12 of the mass of an atom of the nuclide <sup>12</sup>C.

The electronvolt is the kinetic energy acquired by an electron passing through a potential difference of 1 volt in a vacuum.

Quantity	Unit		
	Name	Symbol	Value
Mass	unified atomic mass unit	u	1 u $\approx$ 1,6605655 x 10 <sup>-27</sup> kg
Energy	electronvolt	eV	1eV $\approx$ 1,6021892 x 10 <sup>-19</sup> J

The value of these units, expressed in SI units, is not known exactly.

The prefixes and their symbols listed in F-II, Annex 2, 1.3 may be used in conjunction with these two units and with their symbols.

#### 4. Units and names of units permitted in specialised fields only

Quantity	Unit Name	Symbol	Value
Vergency of optical systems	Dioptre		1 dioptre = $1 \text{ m}^{-1}$
Mass of precious stones	metric carat		1 metric carat = $2 \times 10^{-4} \text{ kg}$
Area of farmland and building land	are	a	1 a = $10^2 \text{ m}^2$
Mass per unit length of textile yarns and threads	tex	tex	1 tex = $10^{-6} \text{ kg.m}^{-1}$
Blood pressure and pressure of other body fluids	millimetre of mercury	mm Hg	1 mm Hg = 133,322 Pa
Effective cross-sectional area	Barn	b	1b = $10^{-28} \text{ m}^2$

The prefixes and their symbols listed in F-II, Annex 2, 1.3 may be used in conjunction with the above units and symbols, with the exception of the millimetre of mercury and its symbol. The multiple of  $10^2$  a is, however, called a "hectare".

#### 5. Compound units

Combinations of the units listed in this annex form compound units.

## Chapter III – Sufficiency of disclosure

### 1. Sufficiency of disclosure

A detailed description of at least one way of carrying out the invention must be given. Since the application is addressed to the person skilled in the art, it is neither necessary nor desirable that details of well-known ancillary features should be given, but the description must disclose any feature essential for carrying out the invention in sufficient detail to render it apparent to the skilled person how to put the invention into practice. A single example may suffice, but where the claims cover a broad field, the application should not usually be regarded as satisfying the requirements of Art. 83 unless the description gives a number of examples or describes alternative embodiments or variations extending over the area protected by the claims. However, regard must be had to the facts and evidence of the particular case. There are some instances where even a very broad field is sufficiently exemplified by a limited number of examples or even one example (see also F-IV, 6.3). In these latter cases the application must contain, in addition to the examples, sufficient information to allow the person skilled in the art, using his common general knowledge, to perform the invention over the whole area claimed without undue burden and without needing inventive skill (see T 727/95). In this context, the "*whole area claimed*" is to be understood as substantially any embodiment falling within the ambit of a claim, even though a limited amount of trial and error may be permissible, e.g. in an unexplored field or when there are many technical difficulties (see T 226/85 and T 409/91).

*Rule 42(1)(e)*

*Art. 83*

With regard to Art. 83, an objection of lack of sufficient disclosure presupposes that there are serious doubts, substantiated by verifiable facts (see T 409/91 and T 694/92). If the Examining Division is able, under the particular circumstances, to make out a reasoned case that the application lacks sufficient disclosure, the onus of establishing that the invention may be performed and repeated over substantially the whole of the claimed range lies with the applicant (see F-III, 4).

For the requirements of Art. 83 and of Rule 42(1)(c) and (e) to be fully satisfied, it is necessary that the invention is described not only in terms of its structure but also in terms of its function, unless the functions of the various parts are immediately apparent. Indeed in some technical fields (e.g. computers), a clear description of function may be much more appropriate than an over-detailed description of structure.

*Art. 83*

*Rule 42(1)(c) and (e)*

In cases where it is found that an application is sufficiently disclosed according to Art. 83 only in respect of a part of the claimed subject-matter, this may have led to the issuing of a partial European or supplementary European search report according to Rule 63 (see B-VIII, 3.1 and 3.2). In such cases, in the absence of appropriate

*Rule 63*

amendment, an objection under Rule 63(3) will also arise (see H-II, 5 and 6.1).

## **2. Art. 83 vs. Art. 123(2)**

*Art. 83*  
*Art. 123(2)*

It is the responsibility of the applicant to ensure that he supplies, on filing his application, a sufficient disclosure, i.e. one that meets the requirements of Art. 83 in respect of the invention as claimed in all of the claims. If the claims define the invention, or a feature thereof, in terms of parameters (see F-IV, 4.11), the application as filed must include a clear description of the methods used to determine the parameter values, unless a person skilled in the art would know what method to use or unless all methods would yield the same result (see F-IV, 4.18). If the disclosure is seriously insufficient, such a deficiency cannot be cured subsequently by adding further examples or features without offending against Art. 123(2), which requires that amendments may not result in the introduction of subject-matter which extends beyond the content of the application as filed (see H-IV, 2.1, see also H-V, 2.2). Therefore, in such circumstances, the application must normally be refused. If, however, the deficiency arises only in respect of some embodiments of the invention and not others, it could be remedied by restricting the claims to correspond to the sufficiently described embodiments only, the description of the remaining embodiments being deleted.

## **3. Insufficient disclosure**

*Art. 83*

Occasionally applications are filed in which there is a fundamental insufficiency in the invention in the sense that it cannot be carried out by a person skilled in the art; there is then a failure to satisfy the requirements of Art. 83 which is essentially irreparable. Two instances deserve special mention. The first is where the successful performance of the invention is dependent on chance. That is to say, the skilled person, in following the instructions for carrying out the invention, finds either that the alleged results of the invention are unrepeatable or that success in obtaining these results is achieved in a totally unreliable way. An example where this may arise is a microbiological process involving mutations. Such a case should be distinguished from one where repeated success is assured even though accompanied by a proportion of failures, as can arise e.g. in the manufacture of small magnetic cores or electronic components. In this latter case, provided the satisfactory parts can be readily sorted by a non-destructive testing procedure, no objection arises under Art. 83. The second instance is where successful performance of the invention is inherently impossible because it would be contrary to well-established physical laws – this applies e.g. to a perpetual motion machine. If the claims for such a machine are directed to its function, and not merely to its structure, an objection arises not only under Art. 83 but also under Art. 52(1) in that the invention is not "susceptible of industrial application" (see G-III, 1).

#### **4. Burden of proof as regards the possibility of performing and repeating the invention**

If there are serious doubts as regards the possibility of performing the invention and repeating it as described, the burden of proof as regards this possibility, or at least a demonstration that success is credible, rests with the applicant or the proprietor of the patent. In opposition, this may be the case where, for example, experiments carried out by the opponent suggest that the subject-matter of the patent does not achieve the desired technical result. As regards the possibility of performing and repeating the invention, see also F-III, 3.

#### **5. Cases of partially insufficient disclosure**

##### **5.1 Only variants of the invention are incapable of being performed**

The fact that only variants of the invention, e.g. one of a number of embodiments of it, are not capable of being performed should not immediately give rise to the conclusion that the subject-matter of the invention as a whole is incapable of being performed, i.e. is incapable of resolving the problem involved and therefore of achieving the desired technical result.

Those parts of the description relating to the variants of the invention which are incapable of being performed and the relevant claims must, however, then be deleted or marked background information that is not part of the invention (see F-IV, 4.3(iii)) at the request of the Division if the deficiency is not remedied. The specification must then be so worded that the remaining claims are supported by the description and do not relate to embodiments which have proved to be incapable of being performed.

##### **5.2 Absence of well-known details**

For the purposes of sufficient disclosure the specification does not need to describe all the details of the operations to be carried out by the person skilled in the art on the basis of the instructions given, if these details are well-known and clear from the definition of the class of the claims or on the basis of common general knowledge (see also F-III, 1 and F-IV, 4.5).

##### **5.3 Difficulties in performing the invention**

An invention should not be immediately regarded as incapable of being performed on account of a reasonable degree of difficulty experienced in its performance ("teething troubles", for example).

*1st example:* The difficulties which could, for example, arise from the fact that an artificial hip joint could be fitted to the human body only by a surgeon of great experience and above-average ability would not prevent manufacturers of orthopaedic devices from deriving complete information from the description with the result that they could reproduce the invention with a view to making an artificial hip joint.

*2nd example:* A switchable semiconductor which, according to the invention, is used for switching electrical circuits on and off without using contacts, thereby making for smoother operation, suffers from teething troubles in that a residual current continues to flow in the circuit when switched off. However, this residual current adversely affects the use of the electrical switch in certain fields only, and can otherwise be reduced to negligible proportions by routine further development of the semiconductor.

## **6. Inventions relating to biological material**

### **6.1 Biological material**

*Rule 26(3)*  
*Rule 31(1)*

Applications relating to biological material are subject to the special provisions set out in Rule 31. In accordance with Rule 26(3), the term "biological material" means any material containing genetic information and capable of reproducing itself or being reproduced in a biological system. If an invention involves the use of or concerns biological material which is not available to the public and which cannot be described in the European patent application in such a manner as to enable the invention to be carried out by a person skilled in the art, the disclosure is not considered to have satisfied the requirements of Art. 83 unless the requirements of Rule 31(1), (2), first and second sentences, and 33(1), first sentence, have been met.

### **6.2 Public availability of biological material**

The examiner must form an opinion as to whether or not the biological material is available to the public. There are several possibilities. The biological material may be known to be readily available to those skilled in the art, e.g. baker's yeast or *Bacillus natto*, which is commercially available, it may be a standard preserved strain, or other biological material which the examiner knows to have been preserved in a recognised depositary institution and to be available to the public without restriction (see Notice from the European Patent Office dated 7 July 2010, OJ EPO 2010, 498). Alternatively, the applicant may have given in the description sufficient information as to the identifying characteristics of the biological material and as to the prior availability to the public without restriction in a depositary institution recognised for the purposes of Rule 33(6) to satisfy the examiner (see Notice from the European Patent Office dated 7 July 2010, OJ EPO 2010, 498). In any of these cases no further action is called for. If, however, the applicant has given no or insufficient information on public availability and the biological material is a particular strain not falling within the known categories such as those already mentioned, then the examiner must assume that the biological material is not available to the public. He must also examine whether the biological material could be described in the European patent application in such a manner as to enable the invention to be carried out by a person skilled in the art (see, in particular, F-III, 3 and G-II, 5.5).

### 6.3 Deposit of biological material

If the biological material is not available to the public and if it cannot be described in the application in such a manner as to enable the invention to be carried out by a person skilled in the art, the examiner must check:

- (i) whether the application as filed gives such relevant information as is available to the applicant on the characteristics of the biological material. The relevant information under this provision concerns the classification of the biological material and significant differences from known biological material. For this purpose, the applicant must, to the extent available to him, indicate morphological and biochemical characteristics and the proposed taxonomic description. *Rule 31(1) and (2)*

The information on the biological material in question which is generally known to the skilled person on the date of filing is as a rule presumed to be available to the applicant and must therefore be provided by him. If necessary, it has to be provided through experiments in accordance with the relevant standard literature.

For characterising bacteria, for example, the relevant standard work would be R.E. Buchanan, N.E. Gibbons: *Bergey's Manual of Determinative Bacteriology*.

Against this background, information should then be given on every further specific morphological or physiological characteristic relevant for recognition and propagation of the biological material, e.g. suitable media (composition of ingredients), in particular where the latter are modified.

Abbreviations for biological material or media are often less well known than the applicant assumes and should therefore be avoided or written in full at least once.

If biological material is deposited that cannot replicate itself but must be replicated in a biological system (e.g. viruses, bacteriophages, plasmids, vectors or free DNA or RNA), the above-mentioned information is also required for such biological system. If, for example, other biological material is required, such as host cells or helper viruses, that cannot be sufficiently described or is not available to the public, this material must also be deposited and characterised accordingly. In addition, the process for producing the biological material within this biological system must be indicated.

In many cases the above required information will already have been given to the depositary institution (see Rule 6.1(a)(iii) and 6.1(b) Budapest Treaty) and need only be incorporated into the application;

- (ii) whether the name of the depositary institution and the accession number of the deposit were supplied at the date of filing. If the name of the depositary institution and the accession number of the deposit were submitted later, it should be checked whether they were filed within the relevant period under Rule 31(2). If that is the case, it should then further be checked whether on the filing date any reference was supplied which enables the deposit to be related to the later filed accession number. Normally the identification reference which the depositor himself gave to his deposit is used in the application documents. The relevant document for later filing the data pursuant to Rule 31(1)(c) could be a letter containing the name of the depositary institution, the accession number and the above-mentioned identification reference or, alternatively, the deposit receipt, which contains all these data (see also G 2/93 and A-IV, 4.2); and
- (iii) whether the deposit was made by a person other than the applicant and, if so, whether the name and the address of the depositor are stated in the application or were supplied within the relevant period under Rule 31(2). In such a case, the examiner must also check whether the document fulfilling the requirements mentioned in Rule 31(1)(d) was submitted to the EPO within the same time limit (see A-IV, 4.1, for details of when this document referred to in Rule 31(1)(d) is required).

The examiner, in addition to the checks referred to under (i) to (iii) above, asks for the deposit receipt issued by the depositary institution (see Rule 7.1 Budapest Treaty) or for equivalent proof of the deposit of a biological material if such proof has not been filed before (see (ii) above and A-IV, 4.2). This is to provide evidence for the indications made by the applicant pursuant to Rule 31(1)(c).

If this deposit receipt has already been filed within the relevant time period according to Rule 31(2), this document on its own is regarded as submission of the information according to Rule 31(1)(c).

*Rule 33(6)*

In addition, the depositary institution named must be one of the recognised institutions listed in the Official Journal of the EPO. An up-to-date list is regularly published in the Official Journal.

If any of these requirements is not satisfied, the biological material in question cannot be considered as having been disclosed pursuant to Art. 83 by way of reference to the deposit.

*Rule 31  
Rule 40(1)(c)  
Rule 56(2) and (3)*

Moreover, there are two situations in which the applicant can file information concerning the deposit which is required under Rule 31(1)(c), and where applicable also under Rule 31(1)(d), in a document filed after the accorded filing date and within the relevant time limit for filing that document, but after the expiry of one of the time limits under Rule 31(2)(a) to (c). As in the preceding paragraph, the consequence of the information being filed after the relevant time limit



under Rule 31(2) is that the biological material is deemed not to have been disclosed pursuant to Art. 83 by way of reference to the deposit. These situations are those in which the information concerning the deposit is contained in either:

- (i) a previously filed application to which reference is made under Rule 40(1)(c), the copy of that application being filed within either the two-month period under Rule 40(3) or that under Rule 55; or
- (ii) missing parts of the description filed later, within the two-month period under Rule 56(2), when the requirements of Rule 56(3) are satisfied, so that the application is not re-dated.

#### **6.4 Priority claim**

An application may claim the priority of a previous application with regard to unavailable biological material mentioned in F-III, 6.1. In this case, the invention is considered disclosed in the previous application for the purpose of the priority claim under Art. 87(1) only if the deposit of the biological material was made no later than the date of filing of the previous application and in accordance with the requirements of the country in which it was filed. Also, the reference to the deposit in the previous application must be made in a manner enabling it to be identified. Where the deposit of the biological material referred to in the European patent application is not the same as the deposit referred to in the priority, it is up to the applicant, if the EPO considers it necessary, to provide evidence that the biological material is identical (see also Notice from the EPO dated 7 July 2010, OJ EPO 2010, 498).

#### **6.5 Euro-PCT cases**

International applications relating to the aforementioned unavailable biological material and designating or electing the EPO must comply with Rule 13*bis* PCT in conjunction with Rule 31. That means that for sufficient disclosure of the material the deposit with a recognised depositary institution must be made not later than the international filing date, relevant information must be given in the application and the necessary indications must be furnished as required during the international phase (see also Notice from the EPO dated 7 July 2010, OJ EPO 2010, 498).

#### **7. Proper names, trademarks and trade names**

The use of proper names, trademarks or trade names or similar words to refer to materials or articles is undesirable insofar as such words merely denote origin or where they may relate to a range of different products. If such a word is used, then, where it is necessary in order to satisfy the requirements of Art. 83, the product must be sufficiently identified, without reliance upon the word, to enable the invention to be carried out by the skilled person at the date of filing. However, where such words have become internationally accepted as standard descriptive terms and have acquired a precise meaning (e.g. "Bowden" cable, "Belleville" washer, "Panhard" rod, "caterpillar"

belt) they may be allowed without further identification of the product to which they relate. For the assessment of the clarity of claims referring to a trademark (Art. 84), see F-IV, 4.8.

### 8. Reference documents

References in European patent applications to other documents may relate either to the background art or to part of the disclosure of the invention.

Where the reference document relates to the background art, it may be in the application as originally filed or introduced at a later date (see F-II, 4.3 and 4.4, and H-IV, 2.3.7).

Where the reference document relates directly to the disclosure of the invention (e.g. details of one of the components of a claimed apparatus), then the examiner should first consider whether knowing what is in the reference document is in fact essential for carrying out the invention as meant by Art. 83.

If not essential, the usual expression “which is hereby incorporated by reference”, or any expression of the same kind, should be deleted from the description.

#### Art. 65

If matter in the document referred to is essential to satisfy the requirements of Art. 83, the examiner should require the deletion of the above-mentioned expression and that, instead, the matter is expressly incorporated into the description, because the patent specification should, regarding the essential features of the invention, be self-contained, i.e. capable of being understood without reference to any other document. One should also bear in mind that reference documents are not part of the text to be translated pursuant to Art. 65 (T 276/99).

Such incorporation of essential matter or essential features is, however, subject to the restrictions set out in H-IV, 2.3.1. It may be that the Search Division has requested the applicant to furnish the document referred to, in order to be able to carry out a meaningful search (see B-IV, 1.3).

If, for the disclosure of the invention, a document is referred to in an application as originally filed, the relevant content of the reference document is to be considered as forming part of the content of the application for the purpose of citing the application under Art. 54(3) against later applications. For reference documents not available to the public before the filing date of the application this applies only if the conditions set out hereto in H-IV, 2.3.1 are fulfilled.

Because of this effect under Art. 54(3), it is very important that, where a reference is directed only to a particular part of the document referred to, that part should be clearly identified in the reference.

## 9. "Reach-through" claims

In certain technical areas (e.g. biotechnology, pharmacy) cases occur where:

- (i) one of the following and its use in a screening method have been defined as the only contribution to the art
  - a polypeptide
  - a protein
  - a receptor
  - an enzyme, etc., or
- (ii) a new mechanism of action of such molecule has been defined.

It may happen that such applications contain so-called "reach-through" claims, i.e. claims directed to a chemical compound (or the use of that compound) defined only in functional terms with regard to the technical effect it exerts on one of the above molecules.

Typical examples of such claims would be: "An agonist/antagonist to polypeptide X [optionally as identified by the screening method of claim A]."; "An agonist/antagonist to polypeptide X [optionally as identified by the screening method of claim A], for use in therapy."; "An agonist/antagonist to polypeptide X [optionally as identified by the screening method of claim A], for use in the treatment of disease Y.", where the description indicates that polypeptide X is involved in disease Y.

According to Art. 83 and Rule 42(1)(c), the claim must contain sufficient technical disclosure of the solution to the problem. A functional definition of a chemical compound ("reach-through" claim) covers all compounds possessing the activity or effect specified in the claim. It would be an undue burden to isolate and characterise all potential compounds (e.g. agonists/antagonists), without any effective pointer to their identity (see F-III, 1), or to test every known compound and every conceivable future compound for this activity to see if it falls within the scope of the claim. In effect, the applicant is attempting to patent what has not yet been invented, and the fact that the applicant can test for the effect used to define the compounds does not necessarily confer sufficiency on the claim; in fact it constitutes an invitation for the skilled person to perform a research programme (see T 435/91 (Reasons 2.2.1), followed by T 1063/06 (Headnote II)).

In general, claims directed to merely functionally defined chemical compounds that are to be found by means of a new kind of research tool (e.g. using a new screening method based on a newly discovered molecule or a new mechanism of action) are directed to future inventions, for which patent protection under the EPC is not designed.

In the case of such "reach-through" claims, it is both reasonable and imperative to limit the subject-matter of the claims to the actual contribution to the art (see T 1063/06 (Headnote I)).

#### **10. Sufficiency of disclosure and Rule 56**

Under Rule 56, missing parts may be withdrawn in order to maintain the original filing date, and these parts are then deemed to be no longer part of the application (see also A-II, 5.4.2 and 5.5, C-III, 1, and H-IV, 2.3.2).

In this case, the examiner must carefully evaluate whether the invention is still sufficiently disclosed without relying on the technical information contained in the withdrawn missing parts. Should the examiner reach the conclusion that the requirements of Art. 83 are not satisfied, a corresponding objection is raised. Ultimately, the application may be refused for lack of sufficient disclosure (see F-III, 3 to 5).

#### **11. Sufficiency of disclosure and clarity**

An ambiguity in the claims may lead to an insufficiency objection. However, ambiguity also relates to the scope of the claims, i.e. Art. 84 (see F-IV, 4). Normally, therefore, an ambiguity in a claim will lead to an objection under Art. 83 only if the whole scope of the claim is affected, in the sense that it is impossible to carry out at all the invention defined therein. Otherwise an objection under Art. 84 is appropriate (see T 608/07).

In particular, where a claim contains an ill-defined ("unclear", "ambiguous") parameter (see also F-IV, 4.11), and the skilled person is not able, on the basis of the disclosure as a whole and using his common general knowledge, to identify (without undue burden) the technical measures necessary to solve the problem underlying the application at issue, an objection under Art. 83 should be raised. The issue in case of an ill-defined parameter, that the skilled person would not know whether he was working within or outside of the scope of the claim, relates to a lack of clear definition and is independently a matter for objection under Art. 84. See T 593/09.

There is a delicate balance between Art. 83 and Art. 84, which has to be assessed on the merits of each individual case. Care has therefore to be taken in opposition that an insufficiency objection is not merely a hidden objection under Art. 84, especially in the case of ambiguities in the claims (T 608/07). On the other hand, even though lack of support/clarity is not a ground for opposition (see also F-IV, 6.4), a problem related to it may in fact be of concern under Art. 83.

#### **12. Sufficiency of disclosure and inventive step**

If the claimed invention lacks reproducibility, this may become relevant under the requirements of sufficiency of disclosure or inventive step. If an invention lacks reproducibility because its desired technical effect as expressed in the claim is not achieved, this results in a lack of

sufficient disclosure, which has to be objected to under Art. 83. Since the technical effect is part of the solution proposed in the claim, it cannot be part of the problem underlying the application. Otherwise, i.e. if the effect is not expressed in the claim but is part of the problem to be solved, there is a problem of inventive step (see G 1/03, reasons 2.5.2, T 1078/08, T 1019/10, T 5/06 and T 380/05).



## Chapter IV – Claims (Art. 84 and formal requirements)

### 1. General

The application must contain "one or more claims".

*Art. 78(1)(c)*

These must:

*Art. 84*

- (i) "define the matter for which protection is sought";
- (ii) "be clear and concise"; and
- (iii) "be supported by the description".

Since the extent of the protection conferred by a European patent or application is determined by the claims (interpreted with the help of the description and the drawings), clarity of the claims is of the utmost importance (see also F-IV, 4).

*Art. 69(1)*

### 2. Form and content of claims

#### 2.1 Technical features

The claims must be drafted in terms of the "technical features of the invention". This means that claims should not contain any statements relating, for example, to commercial advantages or other non-technical matters, but statements of purpose should be allowed if they assist in defining the invention.

*Rule 43(1)*

It is not necessary that every feature should be expressed in terms of a structural limitation. Functional features may be included provided that a skilled person would have no difficulty in providing some means of performing this function without exercising inventive skill (see F-IV, 6.5). For the specific case of a functional definition of a pathological condition, see F-IV, 4.22.

Claims to the use of the invention, in the sense of the technical application thereof, are allowable.

#### 2.2 Two-part form

Rule 43(1)(a) and (b) define the two-part form which a claim should have "wherever appropriate". The first part should contain a statement indicating "the designation of the subject-matter of the invention" i.e. the general technical class of apparatus, process, etc. to which the invention relates, followed by a statement of "those technical features which are necessary for the definition of the claimed subject-matter but which, in combination, are part of the prior art". This statement of prior-art features is applicable only to independent claims and not to dependent claims (see F-IV, 3.4). It is clear from the wording of Rule 43 that it is necessary only to refer to those prior-art features which are relevant to the invention. For example, if the invention

*Rule 43(1)*

relates to a photographic camera but the inventive step relates entirely to the shutter, it would be sufficient for the first part of the claim to read: "A photographic camera including a focal plane shutter" and there is no need to refer also to the other known features of a camera such as the lens and view-finder. The second part or "characterising portion" should state the features which the invention adds to the prior art, i.e. the technical features for which, in combination with the features stated in sub-paragraph (a) (the first part), protection is sought.

If a single document in the state of the art according to Art. 54(2), e.g. cited in the search report, reveals that one or more features in the second part of the claim were already known in combination with all the features in the first part of the claim and in that combination have the same effect as they have in the full combination according to the invention, the examiner should require that such feature or features be transferred to the first part. Where, however, a claim relates to a novel combination, and where the division of the features of the claim between the prior-art part and the characterising part could be made in more than one way without inaccuracy, the applicant should not be pressed, unless there are very substantial reasons, to adopt a different division of the features from that which he has chosen, if his version is not incorrect.

If the applicant insists on including more features in the preamble than can be derived from the closest available prior art, this should be accepted. If no other prior art is available, such a pre-characterising portion could be used to raise an objection on the ground of lack of inventive step.

### **2.3 Two-part form unsuitable**

Subject to what is stated in F-IV, 2.3.2, final sentence, the applicant should be required to follow the above two-part formulation in his independent claim or claims, where, for example, it is clear that his invention resides in a distinct improvement in an old combination of parts or steps. However, as is indicated by Rule 43, this form need be used only in appropriate cases. The nature of the invention may be such that this form of claim is unsuitable, e.g. because it would give a distorted or misleading picture of the invention or the prior art. Examples of the kind of invention which may require a different presentation are:

- (i) the combination of known integers of equal status, the inventive step lying solely in the combination;
- (ii) the modification of, as distinct from addition to, a known chemical process e.g. by omitting one substance or substituting one substance for another; and
- (iii) a complex system of functionally inter-related parts, the inventive step concerning changes in several of these or in their inter-relationships.



In examples (i) and (ii), the Rule 43 form of claim may be artificial and inappropriate, whilst in example (iii) it might lead to an inordinately lengthy and involved claim. Another example in which the Rule 43 form of claim may be inappropriate is where the invention is a new chemical compound or group of compounds. It is likely also that other cases will arise in which the applicant is able to adduce convincing reasons for formulating the claim in a different form.

### 2.3.1 No two-part form

There is a special instance in which the Rule 43 form of claim should be avoided. This is when the only relevant prior art is another European patent application falling within the terms of Art. 54(3). Such prior art should however be clearly acknowledged in the description (see F-II, 4.3, penultimate paragraph, and 4.4).

*Art. 54(3)*

### 2.3.2 Two-part form "wherever appropriate"

When examining whether or not a claim is to be put in the form provided for in Rule 43(1), second sentence, it is important to assess whether this form is "appropriate". In this respect it should be borne in mind that the purpose of the two-part form is to allow the reader to see clearly which features necessary for the definition of the claimed subject-matter are, in combination, part of the prior art. If this is sufficiently clear from the indication of prior art made in the description, to meet the requirement of Rule 42(1)(b), the two-part form should not be insisted upon.

## 2.4 Formulae and tables

The claims, as well as the description, may contain chemical or mathematical formulae but not drawings. The claims may contain tables but "only if their subject-matter makes the use of tables desirable". In view of the use of the word "desirable" in this Rule, the examiner should not object to the use of tables in claims where this form is convenient.

*Rule 49(9)*

## 3. Kinds of claim

### 3.1 Categories

The EPC refers to different "categories" of claim ("products, process, apparatus or use"). For many inventions, claims in more than one category are needed for full protection. In fact, there are only two basic kinds of claim, viz. claims to a physical entity (product, apparatus) and claims to an activity (process, use). The first basic kind of claim ("product claim") includes a substance or compositions (e.g. chemical compound or a mixture of compounds) as well as any physical entity (e.g. object, article, apparatus, machine, or system of co-operating apparatus) which is produced by a person's technical skill. Examples are: "a steering mechanism incorporating an automatic feed-back circuit ..."; "a woven garment comprising ..."; "an insecticide consisting of X, Y, Z"; or "a communication system comprising a plurality of transmitting and receiving stations". The second basic kind of claim ("process claim") is applicable to all kinds of activities in which the use

*Rule 43(2)*

of some material product for effecting the process is implied; the activity may be exercised upon material products, upon energy, upon other processes (as in control processes) or upon living things (see, however, G-II, 4.2 and 5.4).

### 3.2 Number of independent claims

Rule 43(2)

According to Rule 43(2), as applicable to all European patent applications in respect of which a communication under Rule 51(4) EPC 1973 (corresponding to Rule 71(3) EPC 2000) was not issued by 2 January 2002, the number of independent claims is limited to one independent claim in each category.

Exceptions from this rule can only be admitted in the specific circumstances defined in sub-paragraphs (a), (b) or (c) of this rule, provided the requirement of Art. 82 with regard to unity is met (see F-V).

The following are examples of typical situations falling within the scope of the exceptions from the principle of one independent claim per category:

- (i) Examples of a plurality of interrelated products (Rule 43(2)(a))
  - plug and socket
  - transmitter – receiver
  - intermediate(s) and final chemical product
  - gene – gene construct – host – protein – medicament

For the purpose of Rule 43(2)(a), the term "interrelated" is interpreted to mean "different objects that complement each other or work together". In addition, Rule 43(2)(a) can be interpreted as covering apparatus claims, since the term "products" is considered to include apparatuses. Likewise, it may include systems, sub-systems and sub-units of such systems, as long as these entities are interrelated. Interrelated methods claims may also fall under the exception of Rule 43(2)(a).

- (ii) Examples of a plurality of different inventive uses of a product or apparatus (Rule 43(2)(b))
  - claims directed to further medical uses when a first medical use is known (see G-II, 4.2)
  - claims directed to the use of compound X for multiple purposes, e.g. for cosmetically fortifying hair and for promoting hair growth

(iii) Examples of alternative solutions to a particular problem (Rule 43(2)(c))

- a group of chemical compounds
- two or more processes for the manufacture of such compounds

(iv) Examples of allowable claim types

- Claims directed to multiple methods involving a novel and inventive polypeptide P, e.g. an enzyme that controls a specific step in the synthesis of a compound:

a method for manufacturing the polypeptide P,

a method for manufacturing the compound by using either the isolated polypeptide or host cells expressing said polypeptide,

a method for selecting a host cell based on whether or not it expresses the polypeptide of the invention.

- A data sending method for sending a data packet between a plurality of devices coupled to a bus;

a data receiving method for receiving a data packet between a plurality of devices coupled to a bus.

- A certain circuit – apparatus comprising that circuit (the apparatus claim may also be considered to be dependent on the circuit claim, because it comprises all the features of the circuit claim);

- Methods of operating a data-processing system comprising steps A, B, ... – a data-processing apparatus/system comprising means for carrying out said method – a computer program [product] adapted to perform said method – a computer-readable storage medium/data carrier comprising said program;

Note however that when several independent claims are directed to equivalent embodiments that are not sufficiently different (e.g. computer program adapted to perform said method, optionally carried on an electric carrier signal – computer program comprising software code adapted to perform method steps A, B, ...), the exceptions under Rule 43(2) usually do not apply.

For the purpose of Rule 43(2)(c), the term "alternative solutions" can be interpreted as "different or mutually exclusive

possibilities". Moreover, if it is possible to cover alternative solutions by a single claim, the applicant should do so. For example, overlaps and similarities in the features of the independent claims of the same category are an indication that it would be appropriate to replace such claims with a single independent claim, e.g. by selecting a common wording for the essential features (see F-IV, 4.5).

### 3.3 Objection under Rule 43(2) or Rule 137(5)

Where an unjustified plurality of independent claims in the same category persists after the search (see B-VIII, 4.1 and B-VIII, 4.2) in the application under examination, an objection is raised under Rule 43(2). If no Rule 62a(1) invitation was sent at the search stage, the Examining Division can still raise an objection under Rule 43(2). If the application is a Euro-PCT application not subject to the preparation of a supplementary European search report (see B-II, 4.3.1), an objection under Rule 43(2) may also arise in examination.

#### *Rule 43(2)*

When an objection under Rule 43(2) arises, the applicant is invited to amend the claims appropriately. If the search was restricted in accordance with Rule 62a, and the Examining Division upholds the objection under Rule 43(2) despite possible counter-arguments provided by the applicant in his response to the invitation under Rule 62a(1) (see B-VIII, 4.2.2) or to the search opinion under Rule 70a (see B-X, 8), the claims must be amended in such a way as to result in the removal of all subject-matter excluded from the search (Rule 62a(2)) and the description amended accordingly (see H-II, 5).

If in reply to the reasoned objection (raised or confirmed in a communication from the Examining Division) the additional independent claims are maintained and no convincing arguments are presented that one of the situations referred to in sub-paragraphs (a) to (c) of Rule 43(2) applies, the application may be refused under Art. 97(2).

If the application is amended to provide a set of claims complying with Rule 43(2), but containing one or more claims directed to subject-matter excluded from the search in accordance with Rule 62a(1), an objection under Rule 137(5) arises and such amendments may not be admitted (see also H-II, 6 and H-II, 6.1). However, before such a decision can be taken, it will be necessary to allow the applicant to comment according to Art. 113(1) on the underlying issue of whether or not the claims in respect of which the invitation under Rule 62a(1) was sent did in fact comply with Rule 43(2).

The burden of proof concerning an objection under Rule 43(2) is initially shifted onto the applicant, i.e. it is up to the applicant to argue convincingly why additional independent claims can be maintained. For example, the mere statement that the number of claims is the minimum necessary to provide the overall scope of protection which



the applicant seeks is not a convincing argument (see T 56/01, Reasons 5).

Where the application also lacks unity of invention, the examiner may raise an objection under either Rule 43(2) or Art. 82 or under both. The applicant cannot contest which of these objections has priority (see T 1073/98, Reasons 7.2).

### **3.4 Independent and dependent claims**

All applications will contain one or more "independent" claims directed to the essential features of the invention. Any such claim may be followed by one or more claims concerning "particular embodiments" of that invention. It is evident that any claim relating to a particular embodiment must effectively include also the essential features of the invention, and hence must include all the features of at least one independent claim. The term "particular embodiment" should be construed broadly as meaning any more specific disclosure of the invention than that set out in the independent claim or claims.

*Rule 43(3) and (4)*

Any claim which includes all the features of any other claim is termed a "dependent claim". Such a claim must contain, if possible at the beginning, a reference to the other claim, all features of which it includes (see, however, F-IV, 3.8 for claims in different categories). Since a dependent claim does not by itself define all the characterising features of the subject-matter which it claims, expressions such as "characterised in that" or "characterised by" are not necessary in such a claim but are nevertheless permissible. A claim defining further particulars of an invention may include all the features of another dependent claim and should then refer back to that claim. Also, in some cases, a dependent claim may define a particular feature or features which may appropriately be added to more than one previous claim (independent or dependent). It follows that there are several possibilities: a dependent claim may refer back to one or more independent claims, to one or more dependent claims, or to both independent and dependent claims.

*Rule 43(4)*

It sometimes occurs that an independent claim refers explicitly to alternative solutions and that these alternatives are also claimed separately in dependent claims. Such claims may seem redundant, but may be important for the applicant in some national procedures if he wishes to restrict his claims.

The examiner should object to such claims only if they detract from the clarity of the claims as a whole.

*Art. 84*

A dependent claim referring explicitly to independent claims in two categories as alternatives cannot be objected to on this ground alone. For example, if the invention relates to both a composition and a use of that composition, it is possible for a claim specifying further features of the composition to be made dependent on both the independent claim for the composition and the independent claim for its use.

*Art. 84* Objections should, however, be raised to this type of claim dependency if it leads to a lack of clarity.

### **3.5 Arrangement of claims**

*Rule 43(4)*

All dependent claims referring back to a single previous claim and those referring back to several previous claims must be grouped together to the extent and in the most appropriate way possible. The arrangement must therefore be one which enables the association of related claims to be readily determined and their meaning in association to be readily construed. The examiner should object if the arrangement of claims is such as to create obscurity in the definition of the subject-matter to be protected. In general, however, when the corresponding independent claim is allowable, the examiner should not concern himself unduly with the subject-matter of dependent claims, provided he is satisfied that they are truly dependent and thus in no way extend the scope of protection of the invention defined in the corresponding independent claim (see also F-IV, 3.8).

### **3.6 Subject-matter of a dependent claim**

If the two-part form is used for the independent claim(s), dependent claims may relate to further details of features not only of the characterising portion but also of the preamble.

### **3.7 Alternatives in a claim**

*Art. 84*

*Art. 82*

A claim, whether independent or dependent, may refer to alternatives, provided that the number and presentation of alternatives in a single claim does not make the claim obscure or difficult to construe and provided that the claim meets the requirements of unity (see also F-V, 4 and 9). In case of a claim defining (chemical or non-chemical) alternatives, i.e. a so-called "Markush-grouping", unity of invention should be considered to be present if the alternatives are of a similar nature and can fairly be substituted for one another (see F-V, 5).

### **3.8 Independent claims containing a reference to another claim or to features from a claim of another category**

A claim may also contain a reference to another claim even if it is not a dependent claim as defined in Rule 43(4). One example of this is a claim referring to a claim of a different category (e.g. "Apparatus for carrying out the process of claim 1 ...", or "Process for the manufacture of the product of claim 1 ..."). Similarly, in a situation like the plug and socket example of F-IV, 3.2(i), a claim to the one part referring to the other co-operating part (e.g. "plug for co-operation with the socket of claim 1 ...") is not a dependent claim. In all these examples, the examiner should carefully consider the extent to which the claim containing the reference necessarily involves the features of the claim referred to and the extent to which it does not. Indeed, objections on the grounds of lack of clarity and failure to state the technical features (Rule 43(1)) apply to a claim which simply says "Apparatus for carrying out the process of Claim 1". Since the change of category already makes the claim independent, the applicant should be required to set out clearly in the claim the essential features of the apparatus.

The subject-matter of a claim in one category may also to some extent be defined in terms of features from another category; therefore an apparatus may be defined in terms of functions it is able to perform, provided the structure is made sufficiently clear; or a process may be defined in terms of essential structural features of the apparatus for carrying it out; or an element of an apparatus may be defined in terms of how it is made. However, in the wording of these claims and in the assessment of the claimed subject-matter, a clear distinction must be maintained between product claims (for a device, apparatus or system) and process claims (for a process, activity or use). For example, a claim for an apparatus cannot normally be limited only by the manner in which the apparatus is used; for this reason, a claim which simply reads "Apparatus Z, when used for carrying out process Y" should also be objected to on the grounds of lack of clarity and failure to state the technical features (Rule 43(1)).

In the case of a claim for a process which results in the product of a product claim, if the product claim is patentable then no separate examination for the novelty and non-obviousness of the process claim is necessary, provided that all features of the product as defined in the product claim inevitably (see also G-VII, 13) result from the claimed process (see F-IV, 4.5, and T 169/88). This also applies in the case of a claim for the use of a product, when the product is patentable and is used with its features as claimed (see T 642/94). In all other instances, the patentability of the claim referred to does not necessarily imply the patentability of the independent claim containing the reference. It should also be noted that if the process, product and/or use claims have different effective dates (see F-VI, 1 and 2), a separate examination may still be necessary in view of intermediate documents (see also G-VII, 13).

#### **4. Clarity and interpretation of claims**

##### **4.1 Clarity**

The requirement that the claims must be clear applies to individual claims and also to the claims as a whole. The clarity of the claims is of the utmost importance in view of their function in defining the matter for which protection is sought. Therefore, the meaning of the terms of a claim should, as far as possible, be clear for the person skilled in the art from the wording of the claim alone (see also F-IV, 4.2). In view of the differences in the scope of protection which may be attached to the various categories of claims, the examiner should ensure that the wording of a claim leaves no doubt as to its category.

*Art. 84*

Where it is found that the claims lack clarity under Art. 84, this may have led to the issuing of a partial European or supplementary European search report under Rule 63 (see B-VIII, 3.1 and 3.2). In such cases, in the absence of appropriate amendment and/or convincing arguments from the applicant as to why the invitation under Rule 63(1) was not justified, an objection under Rule 63(3) will also arise (see H-II, 5).

## 4.2 Interpretation

Each claim should be read giving the words the meaning and scope which they normally have in the relevant art, unless in particular cases the description gives the words a special meaning, by explicit definition or otherwise. Moreover, if such a special meaning applies, the examiner should, so far as possible, require the claim to be amended whereby the meaning is clear from the wording of the claim alone. This is important because it is only the claims of the European patent, not the description, which will be published in all the official languages of the EPO. The claim should also be read with an attempt to make technical sense out of it. Such a reading may involve a departure from the strict literal meaning of the wording of the claims. Art. 69 and its Protocol do not provide a basis for excluding what is literally covered by the terms of the claims (see T 223/05).

## 4.3 Inconsistencies

Any inconsistency between the description and the claims should be avoided if it may throw doubt on the extent of protection and therefore render the claim unclear or unsupported under Art. 84, second sentence or, alternatively, render the claim objectionable under Art. 84, first sentence. Such inconsistency can be of the following kinds:

(i) Simple verbal inconsistency

For example, there is a statement in the description which suggests that the invention is limited to a particular feature but the claims are not thus limited; also, the description places no particular emphasis on this feature and there is no reason for believing that the feature is essential for the performance of the invention. In such a case, the inconsistency can be removed either by broadening the description or by limiting the claims. Similarly, if the claims are more limited than the description, the claims may be broadened or the description may be limited.

(ii) Inconsistency regarding apparently essential features

For example, it may appear, either from general technical knowledge or from what is stated or implied in the description, that a certain described technical feature not mentioned in an independent claim is essential to the performance of the invention, or, in other words, is necessary for the solution of the problem to which the invention relates. In such a case, the claim does not meet the requirements of Art. 84, because Art. 84, first sentence, when read in conjunction with Rule 43(1) and (3), has to be interpreted as meaning not only that an independent claim must be comprehensible from a technical point of view but also that it must clearly define the subject-matter of the invention, that is to say indicate all the essential features thereof (see T 32/82). If, in response to this objection, the applicant shows convincingly, e.g. by means of additional documents or other evidence, that the feature is in fact not essential, he may be



allowed to retain the unamended claim and, where necessary, to amend the description instead. The opposite situation in which an independent claim includes features which do not seem essential for the performance of the invention is not objectionable. This is a matter of the applicant's choice. The examiner should therefore not suggest that a claim be broadened by the omission of apparently inessential features;

- (iii) Part of the subject-matter of the description and/or drawings is not covered by the claims

For example, the claims all specify an electric circuit employing semiconductor devices but one of the embodiments in the description and drawings employs electronic tubes instead. In such a case, the inconsistency can normally be removed either by broadening the claims (assuming that the description and drawings as a whole provide adequate support for such broadening) or by removing the "excess" subject-matter from the description and drawings. However, if examples in the description and/or drawings which are not covered by the claims are presented not as embodiments of the invention but as background art or examples which are useful for understanding the invention, the retention of these examples may be allowed.

The case under (iii) may frequently occur when, after a limitation of the claims following an invitation under Rule 62a(1) or Rule 63(1), the subject-matter excluded from the search is still present in the description. Unless the initial objection was not justified, such subject-matter should be objected to under Art. 84 (inconsistency between the claims and the description).

#### **4.4 General statements, "spirit" of invention**

General statements in the description which imply that the extent of protection may be expanded in some vague and not precisely defined way should be objected to. In particular, objection should be raised to any statement which refers to the extent of protection being expanded to cover the "spirit" of the invention. Objection should likewise be raised, in the case where the claims are directed to a combination of features, to any statement which seems to imply that protection is nevertheless sought not only for the combination as a whole but also for individual features or sub-combinations thereof.

#### **4.5 Essential features**

##### **4.5.1 Objections arising from missing essential features**

The claims, which define the matter for which protection is sought, must be clear, meaning not only that a claim must be comprehensible from a technical point of view, but also that it must define clearly all the essential features of the invention (see T 32/82). Furthermore, the requirement of Art. 84 that the claims be supported by the description applies to features which are explicitly presented in the description as

*Art. 84  
Rule 43(1) and (3)*

being essential for carrying out the invention (see T 1055/92). A lack of essential features in the independent claim(s) is therefore to be dealt with under the clarity and support requirements.

#### **4.5.2 Definition of essential features**

Essential features of a claim are those necessary for achieving a technical effect underlying the solution of the technical problem with which the application is concerned (the problem usually being derived from the description). The independent claim(s) should therefore contain all features explicitly described in the description as being necessary to carry out the invention. Any features which, even if consistently mentioned in the context of the invention throughout the application, do not actually contribute to the solution of the problem are not essential features.

As a general rule, the technical effect or result produced by the feature will provide the key to answering the question of whether or not the feature contributes to solving the problem (see also G-VII, 5.2).

If a claim is to a process for producing the product of the invention, then the process as claimed should be one which, when carried out in a manner which would seem reasonable to a person skilled in the art, necessarily has as its end result that particular product; otherwise there is an internal inconsistency and therefore lack of clarity in the claim.

In particular, where patentability depends on a technical effect, the claims must be so drafted as to include all the technical features of the invention which are essential for the technical effect (see T 32/82).

#### **4.5.3 Generalisation of essential features**

In deciding how specific the essential features must be, the provisions of Art. 83 should be borne in mind: it is sufficient if the application as a whole describes the necessary characteristics of an invention in a degree of detail such that a person skilled in the art can perform the invention (see F-III, 3). It is not necessary to include all details of the invention in the independent claim. Thus a certain degree of generalisation of the claimed features may be permitted, provided that the claimed generalised features as a whole allow the problem to be solved. In this case a more specific definition of the features is not required. This principle applies equally to structural and functional features.

#### **4.5.4 Implicit features**

As detailed above, an independent claim should specify explicitly all of the essential features needed to define the invention. This applies except insofar as such features are implied by the generic terms used, e.g. a claim to a "bicycle" does not need to mention the presence of wheels.

In the case of a product claim, if the product is of a well-known kind and the invention lies in modifying it in certain respects, it is sufficient that the claim clearly identifies the product and specifies what is modified and in what way. Similar considerations apply to claims for an apparatus.

#### **4.5.5 Examples**

Examples illustrating essential features can be found in the Annex to F-IV.

#### **4.6 Relative terms**

It is preferable not to use a relative or similar term such as "thin", "wide" or "strong" in a claim unless the term has a well-recognised meaning in the particular art, e.g. "high-frequency" in relation to an amplifier, and this is the meaning intended. Where the term has no well-recognised meaning it should, if possible, be replaced by a more precise wording found elsewhere in the original disclosure. Where there is no basis in the disclosure for a clear definition and the term is not essential having regard to the invention, it should normally be retained in the claim, because to excise it would generally lead to an extension of the subject-matter beyond the content of the application as filed - in contravention of Art. 123(2). However, an unclear term cannot be allowed in a claim if the term is essential having regard to the invention. Equally, an unclear term cannot be used by the applicant to distinguish his invention from the prior art.

#### **4.7 Terms like "about" and "approximately"**

Particular attention is required whenever the word "about" or similar terms such as "approximately" or "substantially" are used. Such a word may be applied, for example, to a particular value (e.g. "about 200°C"), to a range (e.g. "about x to about y") or to a structural unit of an apparatus (e.g. "a tray plate with a substantially circular circumference"). In each case, the examiner should use his judgment as to whether the meaning is sufficiently clear in the context of the application read as a whole, and having regard to the meaning a particular technical term qualified by such a word usually has in the field concerned. If such words mean that a certain effect or result can be obtained within a certain tolerance and the skilled person knows how to obtain the tolerance, then the use of such words may be acceptable. If, however, the use of such a word suggests that deviations are included which are larger than those accepted tolerances, then the wording becomes vague and undefined. In any case, the word can only be permitted if its presence does not prevent the invention from being unambiguously distinguished from the prior art with respect to novelty and inventive step.

#### **4.8 Trademarks**

The use of trademarks and similar expressions in claims should not be allowed as it may not be guaranteed that the product or feature referred to is not modified while maintaining its name during the term of the patent. They may be allowed exceptionally if their use is unavoidable and

they are generally recognised as having a precise meaning (see also F-II, 4.14, with regard to the need to acknowledge trademarks as such in the description). With regard to the effect of references to trademarks on sufficiency of disclosure (Art. 83), see F-III, 7.

#### **4.9 Optional features**

Expressions like "preferably", "for example", "such as" or "more particularly" should be looked at carefully to ensure that they do not introduce ambiguity. Expressions of this kind have no limiting effect on the scope of a claim; that is to say, the feature following any such expression is to be regarded as entirely optional.

#### **4.10 Result to be achieved**

The area defined by the claims must be as precise as the invention allows. As a general rule, claims which attempt to define the invention by a result to be achieved should not be allowed, in particular if they only amount to claiming the underlying technical problem. However, they may be allowed if the invention either can only be defined in such terms or cannot otherwise be defined more precisely without unduly restricting the scope of the claims and if the result is one which can be directly and positively verified by tests or procedures adequately specified in the description or known to the person skilled in the art and which do not require undue experimentation (see T 68/85). For example, the invention may relate to an ashtray in which a smouldering cigarette end will be automatically extinguished due to the shape and relative dimensions of the ashtray. The latter may vary considerably in a manner difficult to define whilst still providing the desired effect. So long as the claim specifies the construction and shape of the ashtray as clearly as possible, it may define the relative dimensions by reference to the result to be achieved, provided that the specification includes adequate directions to enable the reader to determine the required dimensions by routine test procedures (see F-III, 1 to 3).

It should be noted that the above-mentioned requirements for allowing a definition of subject-matter in terms of a result to be achieved differ from those for allowing a definition of subject-matter in terms of functional features (see F-IV, 4.22 and 6.5).

Moreover, claims pertaining to a result to be achieved may likewise pose problems in the sense that essential features are missing (see F-IV, 4.5).

#### **4.11 Parameters**

Where the invention relates to a product, it may be defined in a claim in various ways, viz. as a chemical product by its chemical formula, as a product of a process (if no clearer definition is possible; see also F-IV, 4.12) or, exceptionally, by its parameters.

Parameters are characteristic values, which may be values of directly measurable properties (e.g. the melting point of a substance, the flexural strength of a steel, the resistance of an electrical conductor) or

may be defined as more or less complicated mathematical combinations of several variables in the form of formulae.

Characterisation of a product mainly by its parameters should only be allowed in those cases where the invention cannot be adequately defined in any other way, provided that those parameters can be clearly and reliably determined either by indications in the description or by objective procedures which are usual in the art (see T 94/82). The same applies to a process-related feature which is defined by parameters. Cases in which unusual parameters are employed or a non-accessible apparatus for measuring the parameter(s) is used are *prima facie* objectionable on grounds of lack of clarity, as no meaningful comparison with the prior art can be made. Such cases might also disguise lack of novelty (see G-VI, 6).

Use of unusual parameters may however be allowable if it is evident from the application that the skilled person would face no difficulty in carrying out the presented tests and would thereby be able to establish the exact meaning of the parameter and to make a meaningful comparison with the prior art (T 231/01). In addition, the onus of proof that an unusual parameter is a genuine distinctive feature vis-à-vis the prior art lies with the applicant. No benefit of doubt can be accorded in this respect (see G-VI, 6).

Whether the method of and the means for measurement of the parameters need also be in the claim is dealt with in F-IV, 4.18. For further issues relating to clarity, lack of support and sufficiency of disclosure regarding parameters, see F-III, 11, and F-IV, 6.4.

#### **4.12 Product-by-process claim**

Claims for products defined in terms of a process of manufacture are allowable only if the products as such fulfil the requirements for patentability, i.e. *inter alia* that they are new and inventive. A product is not rendered novel merely by the fact that it is produced by means of a new process (see T 150/82). A claim defining a product in terms of a process is to be construed as a claim to the product as such. The claim may for instance take the form "Product X obtainable by process Y". Irrespective of whether the term "obtainable", "obtained", "directly obtained" or an equivalent wording is used in the product-by-process claim, it is still directed to the product *per se* and confers absolute protection upon the product (see T 20/94).

As regards novelty, when a product is defined by its method of manufacture, the question to be answered is whether the product under consideration is identical to known products. The burden of proof for an allegedly distinguishing "product-by-process" feature lies with the applicant, who has to provide evidence that the modification of the process parameters results in another product, for example by showing that distinct differences exist in the properties of the products (see T 205/83). Nevertheless, the examiner needs to furnish reasoned argumentation to support the alleged lack of novelty of a

product-by-process claim, especially if this objection is contested by the applicant (see T 828/08).

*Art. 64(2)*

According to Art. 64(2), if the subject-matter of a European patent is a process, the protection conferred by the patent extends to the products directly obtained by such process. The provisions of this Article are understood to apply to processes producing products completely different from the starting materials as well as to the processes producing only superficial changes (e.g. painting, polishing). However, Art. 64(2) does not affect the examination of claims in respect of their patentability under the EPC and is not to be taken into account by an Examining Division (see T 103/00).

**4.13 "Apparatus for ...", "Method for ...", etc.**

If a claim commences with such words as: "Apparatus for carrying out the process etc..." this must be construed as meaning merely apparatus suitable for carrying out the process. Apparatus which otherwise possesses all of the features specified in the claims but which would be unsuitable for the stated purpose or would require modification to enable it to be so used, should normally not be considered as anticipating the claim.

Similar considerations apply to a claim for a product for a particular use. For example, if a claim refers to a "mold for molten steel", this implies certain limitations for the mold. Therefore, a plastic ice cube tray with a melting point much lower than that of steel would not come within the claim. Similarly, a claim to a substance or composition for a particular use should be construed as meaning a substance or composition which is in fact suitable for the stated use; a known product which *prima facie* is the same as the substance or composition defined in the claim, but which is in a form which would render it unsuitable for the stated use, would not deprive the claim of novelty. However, if the known product is in a form in which it is in fact suitable for the stated use, though it has never been described for that use, it would deprive the claim of novelty. An exception to this general principle of interpretation is where the claim is to a known substance or composition for use in a surgical, therapeutic or diagnostic method (see G-II, 4.2). Similarly, in the data-processing/computer program field, apparatus features of the means-plus-function type ("means for ...") are interpreted as means adapted to carry out the relevant steps/functions, rather than merely means suitable for carrying them out. In this way novelty is conferred over an unprogrammed or differently programmed data-processing apparatus.

In contrast to an apparatus or product claim, in case of a method claim commencing with such words as: "Method for remelting galvanic layers" the part "for remelting ..." should not be understood as meaning that the process is merely suitable for remelting galvanic layers, but rather as a functional feature concerning the remelting of galvanic layers and, hence, defining one of the method steps of the claimed method (see T 848/93).

A distinction does however have to be made where the claim is directed to a method or process aiming at a certain purpose, when it comprises physical steps which result in the production of a product (i.e. the claim is in fact directed towards the production of a product). In this case, the indication of the intended purpose of the method (production of a product) is to be understood in the sense that the method or process has to be merely suitable for that use, rather than comprising the use as an integral method step. Consequently, a prior disclosure of the same method without an indication of the particular purpose (product production), although the method is nevertheless suitable for it, would anticipate a claim to the method for that particular purpose (see T 304/08).

#### 4.14 Definition by reference to use or another entity

Where a claim in respect of a physical entity (product, apparatus) seeks to define the invention by reference to features relating to the entity's use, a lack of clarity can result. This is particularly the case where the claim not only defines the entity itself but also specifies its relationship to a second entity which is not part of the claimed entity (for example, a cylinder head for an engine, where the former is defined by features of its location in the latter). Before considering a restriction to the combination of the two entities, it should always be remembered that the applicant is normally entitled to independent protection of the first entity *per se*, even if it was initially defined by its relationship to the second entity. Since the first entity can often be produced and marketed independently of the second entity, it will usually be possible to obtain independent protection by wording the claims appropriately (for example, by substituting "connectable" for "connected"). If it is not possible to give a clear definition of the first entity *per se*, then the claim should be directed to a combination of the first and second entities (for example, "engine with a cylinder head" or "engine comprising a cylinder head").

It may also be allowable to define the dimensions and/or shape of a first entity in an independent claim by general reference to the dimensions and/or corresponding shape of a second entity which is not part of the claimed first entity but is related to it through use. This particularly applies where the size of the second entity is in some way standardised (for example, in the case of a mounting bracket for a vehicle number-plate, where the bracket frame and fixing elements are defined in relation to the outer shape of the number-plate). However, references to second entities which cannot be seen as subject to standardisation may also be sufficiently clear in cases where the skilled person would have little difficulty in inferring the resultant restriction of the scope of protection for the first entity (for example, in the case of a covering sheet for an agricultural round bale, where the length and breadth of the covering sheet and how it is folded are defined by reference to the bale's circumference, width and diameter, see T 455/92). It is neither necessary for such claims to contain the exact dimensions of the second entity, nor do they have to refer to a combination of the first and second entities. Specifying the length, width and/or height of the first entity

without reference to the second would lead to an unwarranted restriction of the scope of protection.

#### 4.15 The expression "in"

To avoid ambiguity, particular care should be exercised when assessing claims which employ the word "in" to define a relationship between different physical entities (product, apparatus), or between entities and activities (process, use), or between different activities. Examples of claims worded in this way include the following:

- (i) Cylinder head in a four-stroke engine;
- (ii) In a telephone apparatus with an automatic dialler, dial tone detector and feature controller, the dial tone detector comprising ...;
- (iii) In a process using an electrode feeding means of an arc-welding apparatus, a method for controlling the arc welding current and voltage comprising the following steps: ...; and
- (iv) In a process/system/apparatus etc. ... the improvement consisting of...

In examples (i) to (iii) the emphasis is on the fully functioning sub-units (cylinder head, dial tone detector, method for controlling the arc welding current and voltage) rather than the complete unit within which the sub-unit is contained (four-stroke engine, telephone, process). This can make it unclear whether the protection sought is limited to the sub-unit *per se*, or whether the unit as a whole is to be protected. For the sake of clarity, claims of this kind should be directed either to "a unit with (or comprising) a sub-unit" (e.g. "four-stroke engine with a cylinder head"), or to the sub-unit *per se*, specifying its purpose (for example, "cylinder head for a four-stroke engine"). The latter course may be followed only at the applicant's express wish and only if there is a basis for it in the application as filed, in accordance with Art. 123(2).

With claims of the type indicated by example (iv), the use of the word "in" sometimes makes it unclear whether protection is sought for the improvement only or for all the features defined in the claim. Here, too, it is essential to ensure that the wording is clear.

However, claims such as "use of a substance ... as an anticorrosive ingredient in a paint or lacquer composition" are acceptable on the basis of second non-medical use (see G-VI, 7.2, second paragraph).

#### 4.16 Use claims

For the purposes of examination, a "use" claim in a form such as "the use of substance X as an insecticide" should be regarded as equivalent to a "process" claim of the form "a process of killing insects using substance X". Thus a claim in the form indicated should not be interpreted as directed to the substance X recognisable (e.g. by further



additives) as intended for use as an insecticide. Similarly, a claim for "the use of a transistor in an amplifying circuit" would be equivalent to a process claim for the process of amplifying using a circuit containing the transistor and should not be interpreted as being directed to "an amplifying circuit in which the transistor is used", nor to "the process of using the transistor in building such a circuit". However, a claim directed to the use of a process for a particular purpose is equivalent to a claim directed to that very same process (see T 684/02).

Care should be taken when a claim relates to a two-step process which combines a use step with a product production step. This may be the case e.g. when a polypeptide and its use in a screening method have been defined as the only contribution to the art. An example of such a claim would then be:

"A method comprising:

- (a) contacting polypeptide X with a compound to be screened and
- (b) determining whether the compound affects the activity of said polypeptide;

and then formulating any active compound into a pharmaceutical composition."

Many variations of such a claim are conceivable, but in essence they combine (a) a screening step (i.e. using a specified test material to select a compound having a given property) with (b) further production steps (i.e. further transforming the selected compound for instance into the desired composition).

This type of claim is an attempt to gain protection for the composition under Art. 64(2). According to decision G 2/88 there are two different types of process claim, (i) the use of an entity to achieve a technical effect and (ii) a process for the production of a product. This decision makes clear that Art. 64(2) applies only to processes of type (ii). The above claim and its analogues thus represent a combination of two different and irreconcilable types of process claim. Step (a) of the claim relates to a process of type (i), step (b) to a process of type (ii). Step (b) builds on the "effect" achieved by step (a), rather than step (a) feeding into step (b) a specific starting material and resulting in a specific product. This results in an unclear claim according to Art. 84.

#### **4.17 References to the description or drawings**

The claims must not, in respect of the technical features of the invention, rely on references to the description or drawings "except where absolutely necessary". In particular they must not normally rely on such references as "as described in part ... of the description", or "as illustrated in Figure 2 of the drawings". The emphatic wording of the excepting clause should be noted. The onus is upon the applicant to show that it is "absolutely necessary" to rely on reference to the

*Rule 43(6)*

description or drawings in appropriate cases (see T 150/82). An example of an allowable exception would be that in which the invention involves some peculiar shape, illustrated in the drawings, but which cannot be readily defined either in words or by a simple mathematical formula. Another special case is that in which the invention relates to chemical products some of whose features can be defined only by means of graphs or diagrams.

#### **4.18 Method of and means for measuring parameters referred to in claims**

A further special case is where the invention is characterised by parameters. Provided that the conditions for defining the invention in this way are met (see F-IV, 4.11), the definition of the invention should appear completely in the claim itself whenever this is reasonably practicable. In principle the method of measurement is necessary for the unambiguous definition of the parameter. The method of and means for measurement of the parameter values need not however be in the claims when:

- (i) the description of the method is so long that its inclusion would make the claim unclear through lack of conciseness or difficult to understand; in that case the claim should include a reference to the description, in accordance with Rule 43(6);
- (ii) a person skilled in the art would know which method to employ, e.g. because there is only one method, or because a particular method is commonly used; or
- (iii) all known methods yield the same result (within the limits of measurement accuracy).

However, in all other cases the method of and means for measurement should be included in the claims as the claims define the matter for which protection is sought (Art. 84).

#### **4.19 Reference signs**

If the application contains drawings, and the comprehension of the claims would be improved by establishing the connection between the features mentioned in the claims and the corresponding reference signs in the drawings, then appropriate reference signs should be placed in parentheses after the features mentioned in the claims. If there is a large number of different embodiments, only the reference signs of the most important embodiments need be incorporated in the independent claim(s). Where claims are drafted in the two-part form set out in Rule 43(1), the reference signs should be inserted not only in the characterising part but also in the preamble of the claims. Reference signs should not however be seen as limiting the extent of the matter protected by the claims; their sole function is to make claims easier to understand. A comment to that effect in the description is acceptable (see T 237/84).

*Rule 43(7)*

If text is added to reference signs in parentheses in the claims, lack of clarity can arise (Art. 84). Expressions such as "securing means (screw 13, nail 14)" or "valve assembly (valve seat 23, valve element 27, valve seat 28)" are not reference signs in the sense of Rule 43(7) but are special features, to which the last sentence of Rule 43(7) is not applicable. Consequently, it is unclear whether the features added to the reference signs are limiting or not. Accordingly, such bracketed features are generally not permissible. However, additional references to those figures where particular reference signs are to be found, such as "(13 - Figure 3; 14 - Figure 4)", are unobjectionable.

A lack of clarity can also arise with bracketed expressions that do not include reference signs, e.g. "(concrete) moulded brick". In contrast, bracketed expressions with a generally accepted meaning are allowable, e.g. "(meth)acrylate" which is known as an abbreviation for "acrylate and methacrylate". The use of brackets in chemical or mathematical formulae is also unobjectionable.

#### **4.20 Negative limitations (e.g. disclaimers)**

A claim's subject-matter is normally defined in terms of positive features indicating that certain technical elements are present. Exceptionally, however, the subject-matter may be restricted using a negative limitation expressly stating that particular features are absent. This may be done e.g. if the absence of a feature can be deduced from the application as filed (see T 278/88).

Negative limitations such as disclaimers may be used only if adding positive features to the claim either would not define more clearly and concisely the subject-matter still protectable (see G 1/03 and T 4/80) or would unduly limit the scope of the claim (see T 1050/93). It has to be clear what is excluded by means of the disclaimer (see T 286/06). A claim containing one or more disclaimers must also fully comply with the clarity and conciseness requirements of Art. 84 (see G 1/03, Reasons 3). Moreover, in the interests of the patent's transparency, the excluded prior art should be indicated in the description in accordance with Rule 42(1)(b), and the relation between the prior art and the disclaimer should be shown.

For the allowability of disclaimers excluding embodiments that were disclosed in the original application as being part of the invention, see H-V, 4.2. With respect to the allowability of a disclaimer not disclosed in the application as filed, see H-V, 4.1.

#### **4.21 "Comprising" vs. "consisting"**

While in everyday language the word "comprise" may have both the meaning "include", "contain" or "comprehend" and "consist of", in drafting patent claims legal certainty normally requires it to be interpreted by the broader meaning "include", "contain" or "comprehend". On the other hand, if a claim for a chemical compound refers to it as "consisting of components A, B and C" by their

proportions expressed in percentages, the presence of any additional component is excluded and therefore the percentages should add up to 100% (see T 759/91 and T 711/90).

#### **4.22 Functional definition of a pathological condition**

When a claim is directed to a further therapeutic application of a medicament and the condition to be treated is defined in functional terms, e.g. "any condition susceptible of being improved or prevented by selective occupation of a specific receptor", the claim can be regarded as clear only if instructions, in the form of experimental tests or testable criteria, are available from the patent documents or from the common general knowledge allowing the skilled person to recognise which conditions fall within the functional definition and accordingly within the scope of the claim (see T 241/95; see also G-II, 4.2).

#### **4.23 Broad claims**

The Convention does not explicitly mention overly broad claims. However, objections to such claims may arise for various reasons.

Where there are discrepancies between the claims and the description, the claims are not sufficiently supported by the description (Art. 84) and also, in most cases, the invention is not sufficiently disclosed (Art. 83, see T 409/91, and F-IV, 6.1).

*Art. 54 and Art. 56*

Sometimes an objection of lack of novelty arises, for example if the claim is formulated in such broad terms that it also covers known subject-matter from other technical fields. Broad claims may also cover embodiments for which a purported effect has not been achieved. On raising an objection of lack of inventive step in such cases, see G-VII, 5.2.

For broad claims in opposition proceedings, see also D-V, 4 and 5.

#### **4.24 Order of claims**

There is no legal requirement that the first claim should be the broadest. However, Art. 84 requires that the claims must be clear not only individually but also as a whole. Therefore, where there are a large number of claims, they should be arranged with the broadest claim first. If the broadest of a large number of claims is a long way down, so that it could easily be overlooked, the applicant should be required either to re-arrange the claims in a more logical way or to direct attention to the broadest claim in the introductory part or in the summary of the description.

Furthermore, if the broadest claim is not the first one, the later broader claim must also be an independent claim. Consequently, where these independent claims are of the same category, an objection may also arise under Rule 43(2) (see F-IV, 3.2 and 3.3).

## 5. Conciseness, number of claims

The requirement that the claims must be concise refers to the claims in their entirety as well as to the individual claims. The number of claims must be considered in relation to the nature of the invention the applicant seeks to protect. Undue repetition of wording, e.g. between one claim and another, should be avoided by the use of the dependent form. Regarding independent claims in the same category, see F-IV, 3.2 and 3.3. As for dependent claims, while there is no objection to a reasonable number of such claims directed to particular preferred features of the invention, the examiner should object to a multiplicity of claims of a trivial nature. What is or what is not a reasonable number of claims depends on the facts and circumstances of each particular case (see for example T 596/97, Reasons 8). The interests of the relevant public must also be borne in mind. The presentation of the claims should not make it unduly burdensome to determine the matter for which protection is sought (T 79/91 and T 246/91). Objection may also arise where there is a multiplicity of alternatives within a single claim, if this renders it unduly burdensome to determine the matter for which protection is sought.

*Art. 84*

*Rule 43(5)*

Where it is found that the claims lack conciseness under Art. 84, this may lead to the issuing of a partial European or supplementary European search report under Rule 63 (see B-VIII, 3.1 and 3.2). In such cases, in the absence of appropriate amendment and/or convincing arguments from the applicant as to why the invitation under Rule 63(1) was not justified, an objection under Rule 63(3) will also arise (see H-II, 5).

## 6. Support in description

### 6.1 General remarks

The claims must be supported by the description. This means that there must be a basis in the description for the subject-matter of every claim and that the scope of the claims must not be broader than is justified by the extent of the description and drawings and also the contribution to the art (see T 409/91). Regarding the support of dependent claims by the description, see F-IV, 6.6.

*Art. 84*

### 6.2 Extent of generalisation

Most claims are generalisations from one or more particular examples. The extent of generalisation permissible is a matter which the examiner must judge in each particular case in the light of the relevant prior art. Thus an invention which opens up a whole new field is entitled to more generality in the claims than one which is concerned with advances in a known technology. A fair statement of claim is one which is not so broad that it goes beyond the invention nor yet so narrow as to deprive the applicant of a just reward for the disclosure of his invention. The applicant should be allowed to cover all obvious modifications of, equivalents to and uses of that which he has described. In particular, if it is reasonable to predict that all the variants covered by the claims have the properties or uses the applicant ascribes to them in the

description, he should be allowed to draw his claims accordingly. After the date of filing, however, he should be allowed to do so only if this does not contravene Art. 123(2).

### **6.3 Objection of lack of support**

As a general rule, a claim should be regarded as supported by the description unless there are well-founded reasons for believing that the skilled person would be unable, on the basis of the information given in the application as filed, to extend the particular teaching of the description to the whole of the field claimed by using routine methods of experimentation or analysis. Support must, however, be of a technical character; vague statements or assertions having no technical content provide no basis.

The examiner should raise an objection of lack of support only if he has well-founded reasons. Once the examiner has set out a reasoned case that, for example, a broad claim is not supported over the whole of its breadth, the onus of demonstrating that the claim is fully supported lies with the applicant (see F-IV, 4). Where an objection is raised, the reasons should, where possible, be supported specifically by a published document.

A claim in generic form, i.e. relating to a whole class, e.g. of materials or machines, may be acceptable even if of broad scope, if there is fair support in the description and there is no reason to suppose that the invention cannot be worked through the whole of the field claimed. Where the information given appears insufficient to enable a person skilled in the art to extend the teaching of the description to parts of the field claimed but not explicitly described by using routine methods of experimentation or analysis, the examiner should raise a reasoned objection, and invite the applicant to establish, by suitable response, that the invention can in fact be readily applied on the basis of the information given over the whole field claimed or, failing this, to restrict the claim accordingly.

The question of support is illustrated by the following examples:

- (i) a claim relates to a process for treating all kinds of "plant seedlings" by subjecting them to a controlled cold shock so as to produce specified results, whereas the description discloses the process applied to one kind of plant only. Since it is well-known that plants vary widely in their properties, there are well-founded reasons for believing that the process is not applicable to all plant seedlings. Unless the applicant can provide convincing evidence that the process is nevertheless generally applicable, he must restrict his claim to the particular kind of plant referred to in the description. A mere assertion that the process is applicable to all plant seedlings is not sufficient;
- (ii) a claim relates to a specified method of treating "synthetic resin mouldings" to obtain certain changes in physical characteristics.

All the examples described relate to thermoplastic resins and the method is such as to appear inappropriate to thermosetting resins. Unless the applicant can provide evidence that the method is nevertheless applicable to thermosetting resins, he must restrict his claim to thermoplastic resins;

- (iii) a claim relates to improved fuel oil compositions which have a given desired property. The description provides support for one way of obtaining fuel oils having this property, which is by the presence of defined amounts of a certain additive. No other ways of obtaining fuel oils having the desired property are disclosed. The claim makes no mention of the additive. The claim is not supported over the whole of its breadth and objection arises.

Where it is found that the claims lack support in the description under Art. 84, this may lead to the issuing of a partial European or supplementary European search report under Rule 63 (see B-VIII, 3.1 and 3.2). In such cases, in the absence of appropriate amendment and/or convincing arguments provided by the applicant in his response to the invitation under Rule 63(1) (see B-VIII, 3.2) or to the search opinion under Rule 70a (see B-XI, 8), an objection under Rule 63(3) will also arise (see H-II, 5).

#### **6.4 Lack of support vs. insufficient disclosure**

It should be noted that, although an objection of lack of support is an objection under Art. 84, it can often, as in the above examples, also be considered as an objection of insufficient disclosure of the invention under Art. 83 (see F-III, 1 to 3), the objection being that the disclosure is insufficient to enable the skilled person to carry out the "invention" over the whole of the broad field claimed (although sufficient in respect of a narrow "invention"). Both requirements are designed to reflect the principle that the terms of a claim should be commensurate with, or be justified by, the invention's technical contribution to the art. Therefore, the extent to which an invention is sufficiently disclosed is also highly relevant to the issue of support. The reasons for failure to meet the requirements of Art. 83 may in effect be the same as those that lead to the infringement of Art. 84 as well, namely that the invention, over the whole range claimed, extends to technical subject-matter not made available to the person skilled in the art by the application as filed (see T 409/91, Reasons 2 and 3.3 to 3.5).

*Art. 83*

*Art. 84*

For example, where a technical feature is described and highlighted in the description as being an essential feature of the invention, to comply with Art. 84 this must also be part of the independent claim(s) defining the invention (see F-IV, 4.5.1). By the same token, if the (essential) technical feature in question is absent from the claims, and no information is given on how to perform the claimed invention successfully without the use of said feature, the description does not disclose the invention defined in the claim(s) in the manner prescribed by Art. 83.

An objection under both Art. 84 and Art. 83 may also be justified. An example would be a claim relating to a known class of chemical compounds defined by measurable parameters, when the description does not disclose a technical teaching allowing the skilled person to manufacture those compounds complying with the parametric definition, and this is not otherwise feasible by the application of common general knowledge or routine experimentation. Such a claim would be both technically not supported and not sufficiently disclosed, regardless of whether the parametric definition meets the clarity requirement of Art. 84.

Whether the objection is raised as lack of support or as insufficiency is unimportant in examination proceedings; but it is important in opposition proceedings since there only the latter ground is available (see D-III, 5).

### **6.5 Definition in terms of function**

A claim may broadly define a feature in terms of its function, i.e. as a functional feature, even where only one example of the feature has been given in the description, if the skilled reader would appreciate that other means could be used for the same function (see also F-IV, 2.1 and 4.10). For example, "terminal position detecting means" in a claim might be supported by a single example comprising a limit switch, it being evident to the skilled person that e.g. a photoelectric cell or a strain gauge could be used instead. In general, however, if the entire contents of the application are such as to convey the impression that a function is to be carried out in a particular way, with no intimation that alternative means are envisaged, and a claim is formulated in such a way as to embrace other means, or all means, of performing the function, then objection arises. Furthermore, it may not be sufficient if the description merely states in vague terms that other means may be adopted, if it is not reasonably clear what they might be or how they might be used.

### **6.6 Support for dependent claims**

Where certain subject-matter is clearly disclosed in a claim of the application as filed, but is not mentioned anywhere in the description, it is permissible to amend the description so that it includes this subject-matter. Where the claim is dependent, it may suffice if it is mentioned in the description that the claim sets out a particular embodiment of the invention (see F-II, 4.5).



## **Annex**

### **Examples concerning essential features**

#### *Example 1*

Claim 1 relates to a method for storing gel-coated seeds having a gel coat comprising an aqueous gel having been made water-insoluble by a metal ion. The method is characterised by storing the gel-coated seeds in an aqueous solution containing said metal ion. In the description the object of the invention is defined as providing a method for storing gel-coated seeds easily without causing reduction in yield and handling properties. It was emphasised in the description that it is necessary to confine the metal ion concentration to a specific range in order to achieve the goals of the invention. A metal ion concentration outside the specific range was presented as negatively influencing yield and handling properties. The subject-matter of claim 1 - which does not indicate the specific range - therefore does not solve the problem stated in the description.

#### *Example 2*

The invention relates to an apparatus for concave shaping of a metal strip. In the closest prior art, the metal strip is passed transversely to its length through a shaping set of rollers at which the concave shape is applied to the strip. According to the description, the problem is that the rollers are unable to subject the lateral ends of the strip to a curve-creating force and so the lateral ends normally end up planar. The distinguishing feature of the independent claim specifies that a flexible belt or web-like member is provided to support the strip in its passage through the shaping set of rollers. This feature is sufficient to solve the problem. Further features, e.g. the details of the mechanism for advancing the strip into the shaping set of rollers or the provision of at least three rollers, are not necessary to solve the problem: such additional features would unduly restrict the claim (see T 1069/01).

#### *Example 3*

Claim 1 is directed to a shut-off device for preventing the spread of fire in ducts in ventilation systems. According to the description, the problem to be solved is to provide a duct shut-off device which in a non-activated state will offer the lowest possible flow resistance in the ducting. The description consistently discloses that this problem is solved by providing plates extending in the flow direction which are coated with a particular fire-protection paint that expands far more than the material normally used in the art. The inter-plate spacing may thus be increased, which leads to a reduction of flow resistance. However, the adhesion properties of the paint requires that the plates must have a particular length. Since the description consistently indicates that the solution to the problem consists not only in the length dimension of the plates but also in the provision of high-expansion paint, the independent claim has to include this latter feature. It is not sufficient to

define only the dimensions of the plates since this implies neither the use of a specific fire protection material nor an increased spacing of the plates (see T 575/02).

#### *Example 4*

Claim 1 is directed to an apparatus for coding television signals comprising, amongst other features, a parameter generating means which ensures that the error between the pixel data of the predicted and actual current fields is minimised. The description describes only one example for minimising the error, namely a method of least squares. What is important is that the skilled person would be able to realise how the error minimising function can be implemented: it is not relevant in this context whether the method of least squares is the only method applicable. It is therefore not necessary to further restrict the claimed parameter generating means in the sense that it uses a method of least squares (see T 41/91).

#### *Example 5*

According to the description, the object of the invention is to provide a monitor for acquiring and processing EEG data which provides improved signal quality and is impervious to electrical noise pollution. The description indicates that this object is achieved by providing separate data acquisition and data processing modules and by using specific elements - notably a sigma-delta modulator and a decimation filter - in these modules. Since both the modulator and the decimator are of importance in achieving an improved noise ratio performance, both of these components have to be defined in the independent claim. Moreover, since the provision of separate, detachable modules is consistently presented as being of only secondary importance for noise reduction, it is not sufficient that only this feature appears in the independent claim (see T 1126/01).

#### *Example 6*

The description states that a compound C is obtained by reacting a mixture of A and B for at least 10 minutes at 100°C. It is emphasised that A and B must be reacted for this minimum amount of time, as otherwise the reaction will be incomplete and C will not be formed. Claim 1 is directed to a process for the production of compound C, characterised by reacting a mixture of A and B for 5 to 15 minutes at 100°C. The claim does not contain all the essential features of the invention, as the description clearly states that for the reaction to be complete, it is necessary to react A and B for at least 10 minutes.

#### *Example 7*

The description identifies the problem to be solved as providing aerosol compositions wherein the percentage of undesirable volatile organic compounds (VOCs) required as propellant is dramatically decreased, resulting in less VOC release to the atmosphere. Claim 1

specifies the minimum amount of at least 15 weight% of propellant (which is a VOC) in the aerosol, but is completely silent about any maximum amount thereof. The problem underlying the application of releasing less VOCs into the environment is solved only when the propellant does not exceed a particular maximum amount in the aerosol composition: this maximum value is therefore an essential feature of the invention. Claim 1 covers aerosols comprising any amount of propellant greater than or equal to 15 weight%, thereby covering the deficient high percentage of propellant present in conventional aerosols. The percentage of undesirable VOCs in the claimed aerosol compositions is therefore not "dramatically decreased", and so the stated aim of the present invention is not achieved (see T 586/97).

#### *Example 8*

The problem to be solved as indicated in the application consists in improving the yield and purity of the 2-alkylthiazole-5-carboxylic acid chlorides obtained in the preparation process of the invention. Comparative examples show that once the reaction temperature is not within the range from 20°C to reflux, the 2-alkylthiazole-5-carboxylic acid chlorides are not obtained with an improved yield and purity; hence, the desired technical effect is then not achieved and the problem underlying the application is not solved. The problem underlying the application is solved only when the reaction temperature is from 20°C to reflux, with the consequence that this feature is essential to the performance of the invention and must be included in the independent claim (see T 488/96).

#### *Example 9*

As regards diagnostic methods, the Enlarged Board of Appeal has indicated (see G 1/04) that if the deductive medical or veterinary decision phase is unambiguously derivable from the application or patent as a whole, it is to be included as an essential feature in the independent claim. In other words, if the inevitable outcome of the first three phases of such a method (see G-II, 4.2.1.3) is a specific diagnosis for curative purposes allowing the deviation to be attributed to a particular clinical picture, the decision phase must be included in the independent claim in order to fulfil the requirements of Art. 84. However, this may cause a claim to be excluded from patentability under Art. 53(c) (see also G-II, 4.2.1.3). The requirement that the final decision phase be included in the independent claim as an essential feature is to be applied only if it is clear from the application/patent as a whole that the inevitable result of the findings leads unambiguously to a particular diagnosis: this will have to be decided by the examiner on a case-by-case basis.



## Chapter V – Unity of invention

### 1. General remarks

A European application must "relate to one invention only or to a group of inventions so linked as to form a single general inventive concept" (see also B-VII, 1). The second of these alternatives, i.e. the single-concept linked group, may give rise to a plurality of independent claims in the same category provided these claims comply with Rule 43(2) (see F-IV, 3.2 and 3.3), but the more usual case is a plurality of independent claims in different categories.

*Art. 82*  
*Rule 43(2)*

When determining unity of invention, a finding of lack of clarity of the claims is on its own not sufficient grounds for a finding of lack of unity.

*Art. 84*

Normally, too, the sequence of the claims should not have an impact on the determination of unity of invention. However, it will have an impact on which invention is to be considered the first invention mentioned in the claims (see F-V, 8.2).

Moreover, the fact that the claimed separate inventions belong to different groups of the classification is not in itself a reason for a finding of lack of unity.

An application may contain claims of different categories, or several independent claims of the same category. This is not in itself a reason for an objection of lack of unity of invention if the requirements of Art. 82 and Rule 44 are otherwise met (the relationship between Rule 43(2) and Art. 82 is explained in more detail in F-V, 14).

*Rule 43(2)*

With regard to substantive criteria, unity of invention is examined in search and substantive examination in both European and PCT procedures according to the same principles. This does not apply to the respective procedures themselves, where significant differences exist.

*Art. 150(2)*

### 2. Special technical features

Rule 44(1) indicates how one determines whether or not the requirement of Art. 82 is fulfilled when more than one invention appears to be present. The link between the inventions required by Art. 82 must be a technical relationship which finds expression in the claims in terms of the same or corresponding special technical features. The expression "special technical features" means, in any one claim, the particular technical feature or features that define a contribution that the claimed invention considered as a whole makes over the prior art. Once the special technical features of each invention have been identified, one must determine whether or not there is a technical relationship between the inventions and, furthermore, whether or not this relationship involves these special technical features. It is not necessary that the special technical features in each invention be the same. Rule 44(1) makes clear that the required

*Rule 44(1)*

relationship may be found between corresponding technical features. An example of this correspondence is the following: in one claim the special technical feature which provides resilience is a metal spring, whereas in another claim it is a block of rubber.

A plurality of independent claims in different categories may constitute a group of inventions so linked as to form a single general inventive concept. In particular, Rule 44(1) should be construed as permitting the inclusion of any one of the following combinations of claims of different categories in the same application:

- (i) in addition to an independent claim for a given product, an independent claim for a process specially adapted for the manufacture of the said product, and an independent claim for a use of the said product; or
- (ii) in addition to an independent claim for a given process, an independent claim for an apparatus or means specifically designed for carrying out the said process; or
- (iii) in addition to an independent claim for a given product, an independent claim for a process specially adapted for the manufacture of the said product and an independent claim for an apparatus or means specifically designed for carrying out the said process.

However, while a single set of independent claims according to any one of the combinations (i), (ii) or (iii) above is always permissible, a plurality of such sets of independent claims in one European patent application can only be allowed if the specific circumstances defined in Rule 43(2)(a) to (c) apply and the requirements of Art. 82 and 84 are met. The proliferation of independent claims arising out of a combined effect of this kind may therefore be allowed only exceptionally.

Moreover, it is essential that a single general inventive concept links the claims in the various categories. The presence in each claim of expressions such as "specially adapted" or "specifically designed" does not necessarily imply that a single general inventive concept is present.

In combination (i) above, the process is specially adapted for the manufacture of the product if the claimed process results in the claimed product, i.e. if the process is actually suited to making the claimed product accessible and thereby defines a technical relationship as defined in Rule 44(1) between the claimed product and the claimed process (see W 11/99). A manufacturing process and its product may not be regarded as lacking unity simply by virtue of the fact that the manufacturing process is not restricted to the manufacture of the claimed product.

In combination (ii) above, the apparatus or means is specifically designed for carrying out the process if the apparatus or means is suitable for carrying out the process and thereby defines a technical relationship as defined in Rule 44(1) between the claimed apparatus or means and the claimed process. It is not sufficient for unity that the apparatus or means is merely capable of being used in carrying out the process. On the other hand, it is of no importance whether or not the apparatus or means could also be used for carrying out another process or the process could also be carried out using an alternative apparatus or means.

### 3. Intermediate and final products

In the present context of intermediate and final products, the term "intermediate" is intended to mean intermediate or starting products. Such products are made available with a view to obtaining end products through a physical or chemical change in which the intermediate product loses its identity.

Unity of invention should be considered to be present in the context of intermediate and final products where:

- (i) the intermediate and final products have the same essential structural element, i.e. their basic chemical structures are the same or their chemical structures are technically closely inter-related, the intermediate incorporating an **essential** structural element into the final product, and
- (ii) the intermediate and final products are technically inter-related, i.e. the final product is manufactured directly from the intermediate or is separated from it by a small number of intermediates all containing the same **essential** structural element.

Unity of invention may also be present between intermediate and final products of which the structures are not known – for example, as between an intermediate having a known structure and a final product with unknown structure or as between an intermediate of unknown structure and a final product of unknown structure. In such cases, there should be sufficient evidence to lead one to conclude that the intermediate and final products are technically closely inter-related as, for example, when the intermediate contains the same essential element as the final product or incorporates an essential element into the final product.

Different intermediate products used in different processes for the preparation of the final product may be claimed provided that they have the same essential structural element. The intermediate and final products should not be separated, in the process leading from one to the other, by an intermediate which is not new. Where different intermediates for different structural parts of the final product are claimed, unity should not be regarded as being present between the

intermediates. If the intermediate and final products are families of compounds, each intermediate compound should correspond to a compound claimed in the family of the final products. However, some of the final products may have no corresponding compound in the family of the intermediate products, so the two families need not be absolutely congruent.

The mere fact that, besides the ability to be used to produce final products, the intermediates also exhibit other possible effects or activities should not prejudice unity of invention.

#### 4. Alternatives

*Rule 44(2)*

Alternative forms of an invention may be claimed either in a plurality of independent claims, as indicated in F-V, 1, or in a single claim (but see F-IV, 3.7). In the latter case the presence of the two alternatives as independent forms may not be immediately apparent. In either case, however, the same criteria should be applied in deciding whether or not there is unity of invention, and lack of unity of invention may then also exist within a single claim.

#### 5. Markush grouping

Where a single claim defines (chemical or non-chemical) alternatives, i.e. a so-called "Markush grouping", unity of invention should be considered to be present if the alternatives are of a similar nature (see F-IV, 3.7).

When the Markush grouping is for alternatives of chemical compounds, they should be regarded as being of a similar nature where:

- (i) all alternatives have a common property or activity, and
- (ii) a common structure is present, i.e. a significant structural element is shared by all of the alternatives, or all alternatives belong to a recognised class of chemical compounds in the art to which the invention pertains.

A "significant structural element is shared by all of the alternatives" where the compounds share a common chemical structure which occupies a large portion of their structures, or, in case the compounds have in common only a small portion of their structures, the commonly shared structure constitutes a structurally distinctive portion in view of existing prior art. The structural element may be a single component or a combination of individual components linked together. The alternatives belong to a "recognised class of chemical compounds" if there is an expectation from the knowledge in the art that members of the class will behave in the same way in the context of the claimed invention, i.e. that each member could be substituted one for the other, with the expectation that the same intended result would be achieved.



There is no need for the significant structural element to be novel in absolute terms (i.e. novel *per se*). Rather, this expression means that in relation to the common property or activity there must be a common part of the chemical structure which distinguishes the claimed compounds from any known compounds having the same property or activity. However, if it can be shown that at least one Markush alternative is not novel, unity of invention should be reconsidered. In particular, if the structure of at least one of the compounds covered by a Markush claim is known together with the property or technical effect under consideration, this is an indication of lack of unity of the remaining compounds (alternatives).

#### **6. Individual features in a claim**

Objection of lack of unity does not arise because of one claim containing a number of individual features, where these features do not present a technical inter-relationship (i.e. a combination), but merely a juxtaposition (see G-VII, 7).

#### **7. Lack of unity "*a priori*" or "*a posteriori*"**

Lack of unity may be directly evident *a priori*, i.e. before considering the claims in relation to the prior art, or may only become apparent *a posteriori*, i.e. after taking the prior art into consideration - e.g. a document within the state of the art as defined in Art. 54(2) shows that there is lack of novelty or inventive step in an independent claim, thus leaving two or more dependent claims without a common inventive concept (see F-V, 9). In this respect, documents cited under Art. 54(3) should be disregarded in the evaluation of unity of invention, since they cannot anticipate the inventive concept of the application under examination.

#### **8. Examiner's approach**

Although lack of unity may arise *a posteriori* as well as *a priori*, it should be remembered that lack of unity is not a ground of revocation in later proceedings. Therefore, although the objection should certainly be made and amendment insisted upon in clear cases, it should neither be raised nor persisted in on the basis of a narrow, literal or academic approach. This is particularly so where the possible lack of unity does not necessitate a further search. There should be a broad, practical consideration of the degree of interdependence of the alternatives presented, in relation to the state of the art as revealed by the search report. If the common matter of the independent claims is well-known, and the remaining subject-matter of each claim differs from that of the others without there being any unifying novel concept common to all, then clearly there is lack of unity. If, on the other hand, there is a common concept or principle which is novel and inventive, then objection of lack of unity does not arise. For determining what is allowable between these two extremes, rigid rules cannot be given and each case should be considered on its merits, the benefit of any doubt being given to the applicant. For the particular case of claims for a known substance for a number of distinct medical uses, see G-II, 4.2.

When there is lack of unity, the claimed subject-matter is divided among the separate inventions. In this context the word "invention" means an invention having technical character and concerned with a technical problem within the meaning of Art. 52(1) (see G-I, 1 and 2), which does not necessarily need to meet other requirements for patentability, such as novelty and inventive step (see G-VI and G-VII).

### **8.1 Reasoning for a lack of unity objection**

An objection of lack of unity should consist of logically presented, technical reasoning containing the basic considerations behind the finding of lack of unity. When necessary, this comprises the considerations relating to the number and grouping of the claimed separate inventions. In particular, the reasons should highlight the technical problem(s) addressed by the different inventions, unless it is perfectly clear from the remainder of the argumentation that the different inventions could not possibly be subsumed under an overall problem. For each invention or group of inventions the reasons should also specify the special technical features making a contribution over the art or the common general inventive concept, as appropriate. When the objection is based on a document, the relevant passages are appropriately identified.

### **8.2 Determination of the invention first mentioned in the claims**

When lack of unity is established, the sequence of the claimed (groups of) inventions will normally start with the invention first mentioned in the claims ("first" invention); see also B-VII, 1.1 and 2.3. In other words, as a general rule the division of subject-matter follows the order of appearance of the different inventions in the claims. The content of the dependent claims will be taken into account when determining the first invention.

## **9. Dependent claims**

No objection on account of lack of unity *a priori* is justified in respect of a dependent claim and the claim on which it depends, on the ground that the general concept they have in common is the subject-matter of the independent claim, which is also contained in the dependent claim. For example, suppose claim 1 claims a turbine rotor blade shaped in a specified manner, while claim 2 is for a "turbine rotor blade as claimed in claim 1 and produced from alloy Z". The common general concept linking the dependent with the independent claim is "turbine rotor blade shaped in a specified manner".

If, however, the independent claim appears not to be patentable, then the question whether there is still an inventive link between all the claims dependent on that claim needs to be carefully considered (see F-V, 7, non-unity "*a posteriori*"). It may be that the "special technical features" of one claim dependent on this non-patentable independent claim are not present in the same or corresponding form in another claim dependent on that claim (see also C-III, 4.1).

Rule 64(1)

Rule 164(1)

Any claim which refers to an independent claim but does not include all of its features is an independent claim (Rule 43(4)). Examples are a claim referring to another claim of a different category, or a claim specifying an alternative feature which is intended to replace a corresponding feature in the independent claim referred to (for example, an apparatus according to claim 1, wherein component C is replaced by component D).

## 10. Lack of unity during search

In many and probably most instances, lack of unity will have been noted and reported upon by the Search Division which will have drawn up a partial search report based on those parts of the application relating to the invention, or unified linked group of inventions, first mentioned in the claims. The Search Division may neither refuse the application for lack of unity nor require limitation of the claims, but must inform the applicant that, if the search report is to be drawn up to cover those inventions present other than the first mentioned, then further search fees must be paid within two months.

*Rule 64(1) and (2)*

## 11. Lack of unity during substantive examination

### 11.1 General principles

The final responsibility for establishing whether the application meets the requirement of unity of invention ultimately rests with the Examining Division (see T 631/97; see also C-III, 3.1). For Euro-PCT applications which have entered the European phase, see F-V, 13.

Whether or not the question of unity of invention has been raised by the Search Division, it must always be considered by the Examining Division. The conclusion reached may change, e.g. when further prior art becomes available at a later stage of the proceedings. When lack of unity of invention arises only during substantive examination, the examiner should raise an objection only in clear cases, particularly if substantive examination is at an advanced stage (see also H-II, 7.3).

Whenever unity is found to be lacking, the applicant should be required to limit his claims in such a way as to overcome the objection (see C-III, 3.1 and 3.2), which means restricting them to a single searched invention (see H-II, 7.1). Excision or amendment of parts of the description may also be necessary (see F-V, 4). One or more divisional applications, covering matter removed to meet this objection, may be filed (see C-IX, 1), provided that the parent application is pending (A-IV, 1.1.1).

*Rule 36(1)*

### 11.2 Objections to unsearched inventions

See H-II, 7.2 and 7.3.

### 11.3 Review of non-unity findings

The reviewing of non-unity findings and the refund of additional search fees are dealt with in C-III, 3.3.



Insofar as the Examining Division finds that unity of invention is given, if the applicant has paid the further search fee(s) and requested a full or partial refund thereof, the Examining Division will order refund of the relevant further search fee(s).

## 12. Amended claims

*Rule 137(5)*

For the situation where the applicant submits new claims directed to subject-matter which has not been searched e.g. because it was only contained in the description and at the search stage it was not found to be appropriate to extend the search to this subject-matter, see H-II, 6.2, and B-III, 3.5.

## 13. Euro-PCT applications

### 13.1 International applications without supplementary search

*Art. 153(7)*

As indicated in B-II, 4.3.1, for certain international applications entering the European phase with an international search report, no supplementary European search is carried out. The following situations may then be distinguished during substantive examination:

(i) If, during the international search, an objection of lack of unity has been raised and the applicant has not taken the opportunity to have the other invention(s) searched by paying additional search fees for them, but has taken the opportunity to amend the claims after receipt of the international search report (see E-VIII, 3.3.1) so that they are limited to the invention searched and has indicated that examination is to be carried out on these amended claims, the examiner proceeds on the basis of these claims.

*Rule 164(2)*

(ii) If, during the international search, an objection of lack of unity has been raised and the applicant has **neither** taken the opportunity to have the other invention(s) searched by paying additional search fees for them, **nor** amended the claims so that they are limited to the invention searched, **and** the examiner agrees with the objection of the ISA (taking into account any comments on the issue of unity submitted by the applicant in his response to the WO-ISA or IPER, see E-VIII, 3.3.1), he will then proceed to issue an invitation under Rule 164(2) to pay search fees for any claimed invention in the application documents for which no additional search fee has been paid to the EPO, where it has acted as the ISA.

(iii) If the applicant has paid additional search fees during the international phase, he may determine that the application is to proceed on the basis of any of the searched inventions, the other(s) being deleted, if the examiner agrees with the objection of the ISA. Where the applicant has not yet taken that decision, the examiner will, at the beginning of substantive examination, invite him to do so.

- (iv) If the claims to be examined relate to an invention which differs from any of the originally claimed inventions, the examiner will proceed to issue an invitation under Rule 164(2) to pay search fees for any claimed invention in the application documents not covered by the international search report or supplementary international search report, if any (see C-III, 2.3).
- (v) If the applicant has not paid additional search fees during the international phase and the examiner does not agree with the objection of the ISA (for example, because the applicant has convincingly argued in response to the WO-ISA or IPER, see E-VIII, 3.3.1, that the requirement of unity of invention is satisfied), an additional search will be performed (see B-II, 4.2(iii)) and the examination will be carried out on all claims.

In cases (i) to (iv), the applicant may file divisional applications for the inventions deleted to meet the objection of non-unity (see C-IX, 1, and A-IV, 1), provided that, when a divisional application is filed, the application being divided is still pending (see A-IV, 1.1.1).

*Rule 36(1)*

### 13.2 International applications with supplementary search

For international applications entering the European phase with an international search report established by an ISA other than the EPO, a supplementary European search is carried out by the Search Division in the cases listed in B-II, 4.3.2. If the Search Division, during the supplementary European search, notes a lack of unity, B-VII, 2.3 applies.

*Art. 153(7)*

*Rule 164(1)*

The procedure before the Examining Division in such cases is described in E-VIII, 4.2. In brief, the examiner will proceed with the examination of that invention (or group of inventions) covered by the supplementary European search report which has been chosen by the applicant in response to the ESOP.

### 13.3 International preliminary examination report (IPER)

For international applications entering the European phase with an international preliminary examination report, the examiner should carefully take into account the position taken in that IPER before deviating from it. This may be necessary where the claims have been changed, the applicant successfully refutes the objection (either of which may happen in response to the IPER, see E-VIII, 3.3.1) or the interpretation of the rules regarding unity of invention was erroneous; see further F-V, 13.1 and 13.2 above.

### 13.4 Restricted IPER

If the EPO has established an IPER on the application and the applicant wishes to obtain protection pertaining to claims which were not the subject of this IPER because they were not searched during the international phase in consequence of an objection of lack of unity, he can decide to have such claims searched in response to the invitation

*Art. 76*

*Rule 164(2)*

to pay additional search fees under Rule 164(2) and choose them for further prosecution. Alternatively, he can decide to file one or more divisional applications for the inventions not searched, provided that, when a divisional application is filed, the application being divided is still pending (see A-IV, 1.1.1).

#### **14. Relationship between Rule 43(2) and Art. 82**

Rule 43(2) refers expressly to Art. 82. This makes clear that the requirement of unity has to be met by the subject-matter of the independent claims in the same category. Thus, special technical features relating to the single general inventive concept within the meaning of Rule 44 must be either implicitly or explicitly present in each of the independent claims.

Several independent claims in the same category directed to interrelated subject-matter may meet the requirement of unity even if it appears that the claimed subject-matter is quite different, provided that the special technical features making a contribution over the prior art are the same or corresponding within the meaning of Rule 44. Examples of such situations include a transmitter claimed together with a corresponding receiver, a plug claimed with a corresponding socket, etc. (see also F-IV, 3.2).

Special attention is required in the case of claims characterised by a combination of elements (e.g. A+B+C), accompanied by claims relating to sub-combinations (e.g. A+B, A+C, B+C or A, B, C separately). Even if the claimed sub-combinations define patentable subject-matter, and the combination claim includes all the features of the claimed sub-combinations, lack of unity of invention may still arise.

Where the application both lacks unity of invention and fails to comply with the requirements of Rule 43(2), the examiner may raise an objection under either Rule 43(2) or Art. 82 or under both. The applicant cannot contest which of these objections has priority (see T 1073/98, Reasons 7.2).

## Chapter VI – Priority

### 1. The right to priority

In this respect see also A-III, 6.

#### 1.1 Filing date as effective date

According to Art. 80, a European application is accorded as its date of filing the date on which it satisfies the requirements of Rule 40, or, if filed under the PCT, the date on which it satisfies Art. 11 PCT. This date remains unchanged except in the special circumstances of late-filed drawings or parts of the description provided for in Rule 56 EPC and Art. 14(2) PCT.

*Rule 40*

The date of filing may be the only effective date of the application. It will be of importance for fixing the expiry of certain time limits (e.g. the date by which the designation of the inventor must be filed under Rule 60), for determining the state of the art relevant to the novelty or obviousness of the subject-matter of the application, and for determining, in accordance with Art. 60(2), which of two or more European applications from separate persons for the same invention is to proceed to grant.

#### 1.2 Priority date as effective date

However, in many cases, a European application will claim the right of priority of the date of filing of a previous application. In such cases, it is the priority date (i.e. the date of filing of the previous application) which becomes the effective date for the purposes mentioned in the preceding paragraph.

*Art. 89*

#### 1.3 Validly claiming priority

For a valid claim to priority, the following conditions must be satisfied:

*Art. 87(1) and (5)*

- (i) the previous application must be one of those referred to in A-III, 6.2;
- (ii) the previous application whose priority is claimed must have been filed by the applicant of the European application or his predecessor in title;
- (iii) the previous application must have been filed not more than 12 months before the filing date of the European application (subject to certain exceptions, see A-III, 6.6); and
- (iv) the previous application must have been the "first application" filed in respect of the same invention as the one to which the European application relates (see F-VI, 1.4 and 1.4.1).

As concerns (i), the words "in or for" any Member State of the Paris Convention or Member of the WTO, referred to in A-III, 6.2, mean that priority may be claimed in respect of a previous national application, a

*Art. 87(2) and (3)*

previous European application, a previous application filed under another regional patent treaty or a previous PCT application. If the previous application was filed in or for an EPC Contracting State, this State may also be designated in the European application. The previous application may be for a patent or for the registration of a utility model or for a utility certificate. However, a priority right based on the deposit of an industrial design is not recognised (see J 15/80). So long as the contents of the application were sufficient to establish a filing date, it can be used to create a priority date, no matter what the outcome of the application may be; for example, it may subsequently be abandoned or refused (see A-III, 6.2).

As concerns (ii) and (iii), see A-III, 6.1 and 6.6, respectively.

*Art. 87(1)*

As concerns (iv), the expression "the same invention" in Art. 87(1) means that the subject-matter of a claim in a European application may enjoy the priority of a previous application only if the skilled person can derive the subject-matter of the claim directly and unambiguously, using common general knowledge, from the previous application as a whole. This means that the specific combination of features present in the claim must at least implicitly be disclosed in the previous application (see F-VI, 2.2 and G 2/98).

#### **1.4 First application**

*Art. 87(1)*

The filing date of the "first application" must be claimed as a priority, i.e. the application disclosing for the first time any or all of the subject-matter of the European application. If it is found that the application to which the priority claim is directed is in fact not the first application in this sense, but some or all of the subject-matter was disclosed in a still earlier application filed by the same applicant or his predecessor in title, the priority claim is invalid insofar as the subject-matter was already disclosed in the still earlier application (see F-VI, 1.4.1).

To the extent the priority claim is invalid, the effective date of the European application is the date of its filing. The previously disclosed subject-matter of the European application is not novel if the still earlier application referred to above was published prior to the effective date of the European application (Art. 54(2)) or if the still earlier application is also a European application which was published on or after the effective date of the European application in question (Art. 54(3)).

##### **1.4.1 Subsequent application considered as first application**

*Art. 87(4)*

A subsequent application for the same subject-matter and filed in or for the same State or Member of the WTO is considered as the "first application" for priority purposes if, at the date this subsequent application was filed, the still earlier application had been withdrawn, abandoned or refused, without being open to public inspection and without leaving any rights outstanding, and had not served as a basis for claiming priority. The EPO will not consider this question unless there is evidence of the existence of a still earlier application as, for



example, in the case of a United States continuation-in-part application. Where it is clear that a still earlier application for the same subject-matter exists, and where the priority right is important because of intervening prior art (see F-VI, 2.1), the applicant should be required to establish by evidence from an appropriate authority (normally a national patent office) that there were no rights outstanding in the still earlier application in respect of the subject-matter of the application being examined.

Examples of applications that cannot be recognised as a "first application" within the meaning of Art. 87(4) are:

- (i) US applications which are a "continuation" of a previous application ("con");
- (ii) US applications which are a "continuation in part" of a previous application ("cip"), in so far as the subject-matter in question was already disclosed in the original US application;
- (iii) national applications claiming priority from a previous national application or national utility model.

In the case of US con or cip applications, the first sentence of the description reads as follows: "This application is a continuation in part (continuation) of Serial Number .... filed ....." . The following information is found on the title page under the heading "CONTINUING DATA\*\*\*\*\*": "VERIFIED THIS APPLICATION IS A CIP (or CON) OF ....." . A form headed "Declaration for Patent Application" must also be attached to the end of the application (in this case the priority document), listing earlier foreign or US applications under the heading "foreign priority benefits under Title 35, United States Code, 119" or "benefit under Title 35, U.S.C., 120 of any United States application(s)".

Applications may be filed by reference to a previously filed application (see A-II, 4.1.3.1). If no priority is claimed from this previously filed application, the filing by reference itself does not generate outstanding rights according to Art. 87(4).

*Rule 40(1)(c)*

For example, in the case of national applications GB1 (filed on 1 February 2002, without claiming priority) and GB2 (filed on 2 January 2008, without claiming priority), pertaining to the same subject-matter, a European application EP1 (filed on 2 January 2009) claims priority of GB2 but refers to GB1 for its content according to Rule 40(1)(c). If GB1 is withdrawn, abandoned or refused, without being open to public inspection and without having served as a basis for claiming a right of priority, the mere reference to it under Rule 40(1)(c) does not amount to an outstanding right within the meaning of Art. 87(4). Consequently, in this case the priority claim to GB2 has to be considered valid for EP1.

## 1.5 Multiple priorities

*Art. 88(2) and (3)*

"Multiple priorities may be claimed" – i.e. a European application may claim rights of priority based on more than one previous application. The previous application may have been filed in or for the same or different States or Members of the WTO, but in all cases the earliest application must have been filed not more than 12 months before the date of filing of the European application. Subject-matter of a European application will be accorded the priority date of the earliest priority application which discloses it. If, for instance, the European application describes and claims two embodiments (A and B) of an invention, A being disclosed in a French application and B in a German application, both filed within the preceding 12 months, the priority dates of both the French and German applications may be claimed for the appropriate parts of the European application; embodiment A will have the French priority date and embodiment B the German priority date as effective dates. If embodiments A and B are claimed as alternatives in one claim, these alternatives will likewise have the different priority dates as effective dates. If, on the other hand, a European application is based on one previous application disclosing a feature C and a second previous application disclosing a feature D, neither disclosing the combination of C and D, a claim to that combination will be entitled only to the date of filing of the European application itself. In other words, it is not permitted to "mosaic" priority documents. An exception might arise where one priority document contains a reference to the other and explicitly states that features from the two documents can be combined in a particular manner.

## 2. Determining priority dates

### 2.1 Examining the validity of a right to priority

As a general rule, the examiner should not make any investigation as to the validity of a right to priority. However, the priority right assumes importance if prior art has to be taken into account which has been made available to the public within the meaning of Art. 54(2) on or after the priority date claimed and before the date of filing (e.g. an intermediate document, see G-IV, 3) or if the content of the European patent application is totally or partially identical with the content of another European application within the meaning of Art. 54(3), such other application claiming a priority date within that period. In such cases, (i.e. cases where the art in question would be relevant if of earlier date) the examiner must investigate whether the priority date(s) claimed may be accorded to the appropriate parts of the application he is examining and should inform the applicant of the outcome and whether, in consequence, the particular prior art under consideration, e.g. the intermediate document, or the other European application forms part of the state of the art within the meaning of Art. 54. Also, in the case of possible conflict with another European application under Art. 54(3), it may be necessary in addition to allocate effective dates to the appropriate parts of that other application and to communicate this to the applicant analogously (see also G-IV, 3). When the examiner

needs to consider the question of priority date, he should bear in mind all the matters which are mentioned in F-VI, 1.3 to 1.5 above.

If in case of a Euro-PCT application, where the EPO is acting as a designated or elected Office, the priority document is not on file, substantive examination may nevertheless be started. In such a case, without the priority document being on file, the application may even, where appropriate, be refused because the claimed subject-matter lacks novelty or inventive step, provided that the relevant state of the art is neither an intermediate document nor an Art. 54(3) application. However, no European patent may be granted until such time as the priority document is on file. In such a case, the applicant is informed that the decision to grant will not be taken as long as the priority document is missing.

If intermediate documents or Art. 54(3) applications exist and the patentability of the subject-matter claimed depends on the validity of the priority right, substantive examination cannot be finalised as long as the priority document is missing. Where the applicant has complied with Rule 17.1(a), (b) or (b-bis) PCT, he may not be requested to file the priority document. The proceedings have to be stayed and the applicant is informed that, since the patentability of the subject-matter claimed depends on the validity of the priority right, substantive examination cannot be finalised as long as the priority document is not on file.

## **2.2 The same invention**

The basic test to determine whether a claim is entitled to the date of a priority document is, as far as the requirement of "the same invention" is concerned (see F-VI, 1.3(iv)), the same as the test for determining whether or not an amendment to an application satisfies the requirement of Art. 123(2) (see H-IV, 2). That is to say, for the priority date to be valid in this respect the subject-matter of the claim must be directly and unambiguously derivable from the disclosure of the invention in the priority document, also taking into account any features implicit to a person skilled in the art in what is expressly mentioned in the document (see G 2/98). As an example of an implicit disclosure, a claim to an apparatus including "releasable fastening means" would be entitled to the priority date of a disclosure of that apparatus in which the relevant fastening element was, say, a nut and bolt, or a spring catch or a toggle-operated latch, provided the general concept of "releasable" is implicit in the disclosure of such element. An example of where the subject-matter is not directly and unambiguously derivable is when the claim is directed to a specific numerical range of values and the priority application discloses a different numerical range of values, even if this latter range overlaps with or is comprised within the previous one. In such a case, the claimed amounts represent a continuum of a numerical range of values which does not correspond to distinctive, alternative embodiments (i.e. elements in the sense of Art. 88(3)). Therefore no separable alternative embodiments which could enjoy the right of priority are identifiable within that continuum (T 1877/08).

**Art. 88(4)**

It is not necessary that the subject-matter for which priority is claimed be found among any claims in the previous application. It is sufficient that the documents of the previous application taken as a whole "specifically disclose" such subject-matter. The description and any claims or drawings of the previous application should, therefore, be considered as a whole in deciding this question, except that account should not be taken of subject-matter found solely in that part of the description referring to prior art, or in an explicit disclaimer.

The requirement that the disclosure must be specific means that it is not sufficient if the subject-matter in question is merely referred to in broad and general terms. A claim to a detailed embodiment of a certain feature would not be entitled to priority on the basis of a mere general reference to that feature in a priority document. Exact literal correspondence is not required, however. It is enough that, on a reasonable assessment, there is in substance a disclosure of the same subject-matter of the claim.

A disclaimer which is allowable under Art. 123(2) (see H-V, 4.1 and 4.2) does not change the identity of the invention within the meaning of Art. 87(1). Therefore, such a disclaimer could be introduced when drafting and filing a successive European patent application, without affecting the right to priority from the first application not containing the disclaimer (see G 1/03, G 2/03 and G 2/10).

**2.3 Priority claim not valid**

If the tests set out in F-VI, 2.2 are not satisfied in relation to a particular previous application, then the effective date of the subject-matter of the claim in question will either be the filing date of the earliest application which does provide the required disclosure and of which the priority is validly claimed (see G 3/93) or, in the absence of such, will be the date of filing of the European application itself (or the new date of filing if the application has been re-dated under Rule 56).

**2.4 Some examples of determining priority dates**

Note: the dates used are merely illustrative; they do not take account of the fact that the filing offices of the EPO are closed on weekends and certain public holidays.

**2.4.1 Intermediate publication of the contents of the priority application**

P is the application from which priority is claimed by EP, D is the disclosure of the subject-matter of P.

1.1.90  
filing  
P

1.5.90  
publication  
D

1.6.90  
filing  
EP

D is state of the art under Art. 54(2) if the priority claim of P is not valid.

### 2.4.2 Intermediate publication of another European application

P1 is the application from which priority is claimed by EP1, P2 the one from which EP2 claims priority. EP1 and EP2 are filed by different applicants.

1.2.89	1.1.90	1.2.90	1.8.90	1.1.91
filing	filing	filing	publication	filing
P1	P2	EP1	EP1	EP2
A + B	A + B	A + B	A + B	A + B

EP1 is state of the art under Art. 54(3) if the respective priority claims of P1 and P2 are valid. This does not change if the publication of EP1 takes place after the filing date of EP2. The publication of EP1 is state of the art under Art. 54(2) if the priority claim of P2 is not valid.

### 2.4.3 Multiple priorities claimed for different inventions in the application with an intermediate publication of one of the inventions

EP claims priority of P1 and P2, D is the disclosure of A+B.

1.1.90	1.2.90	1.3.90	1.6.90
filing	publication	filing	filing
P1	D	P2	EP
A + B	A + B	A + B + C	claim 1: A + B claim 2: A + B + C

Claim 1 has a valid priority of P1 for its subject-matter, thus publication D is not state of the art under Art. 54(2) against this claim. Claim 2 cannot benefit from the priority of P1, as it does not concern the same subject-matter. Thus publication D is state of the art under Art. 54(2) for this claim (see G 3/93). It is immaterial whether claim 2 is in the form of a dependent or an independent claim.

### 2.4.4 A situation in which it has to be checked whether the application from which priority is actually claimed is the "first application" in the sense of Art. 87(1)

P1 is the earliest application of the same applicant containing the invention. EP claims the priority of the later US application P2, which is a "continuation-in-part" of P1. D is a public disclosure of A+B.

1.7.89	1.1.90	1.6.90	1.12.90
filing	filing	publication	filing
P1	P2 (cip)	D	EP
A + B	A + B A + B + C	A + B	claim 1: A + B claim 2: A + B + C

The priority claim of P2 for claim 1 is not valid as P2 is not the "first application" for this subject-matter in the sense of Art. 87(1), but P1 is, which has "left rights outstanding" in that P2 is a "continuation-in-part" thereof. Therefore Art. 87(4) does not apply and this is not altered by an abandonment, withdrawal, refusal or non-publication of P1. D is prior art pursuant to Art. 54(2) against claim 1, but not against claim 2, as the latter claim has the earlier priority of P2.

### 3. Claiming priority

#### 3.1 General remarks

*Art. 88(1)*

*Rule 52(1)*

*Rule 53(1) and (3)*

An applicant who wishes to claim priority must file a declaration of priority giving particulars of the previous filing, as specified in Rule 52(1), together with a certified copy of the previous application and, if necessary for the assessment of patentability, a translation of it into one of the EPO official languages (see A-III, 6.7 and 6.8).

#### 3.2 Declaration of priority

*Rule 52(1) and (2)*

A declaration of priority from an earlier filing should preferably be made at the time of filing the European application, although this can be done at any time within 16 months from the earliest priority date claimed (see A-III, 6.5.1). The declaration of priority must indicate the date of the priority application, the relevant State party to the Paris Convention or Member of the WTO, and the file number.

*Rule 52(3)*

A declaration of priority may be corrected within 16 months from the earliest priority date. This time limit cannot expire earlier than four months after the filing date (see A-III, 6.5.2).

#### 3.3 Certified copy of the previous application (priority document)

*Rule 53(1)*

The certified copy of the previous application, i.e. the priority document, must be filed within 16 months of the priority date (see A-III, 6.7, for Euro-PCT cases see, however, E-VIII, 2.3.5), unless such a copy is already on file because it has been supplied in the context of Rule 40(3), see A-II, 4.1.3.1, or of a request pursuant to Rule 56, see A-II, 5.4.3.

*Rule 53(2)*

Moreover, in accordance with Rule 53(2) and the Decision of the President of the EPO dated 9 August 2012, OJ EPO 2012, 492, the EPO will include a copy of the previous application in the file of the European patent application without charging a fee, if the previous application is:

- (i) a European patent application;
- (ii) an international application filed with the EPO as receiving Office under the PCT;
- (iii) a Chinese patent or utility model application;

- (iv) a Japanese patent or utility model application;
- (v) a United States provisional or non-provisional patent application; or
- (vi) a Korean patent or utility model application.

No request is necessary to this end. However, as regards Chinese patent or utility model applications, this applies only if these were filed on or after 3 September 2012. If the previous application is a United States application, please see the Notice from the European Patent Office dated 27 June 2007 concerning practical aspects of the electronic exchange of priority documents between the EPO and the USPTO (OJ EPO 2007, 473). As soon as the EPO has included in the file of the European patent application a copy of the previous application, it informs the applicant accordingly.

### 3.4 Translation of the previous application

A translation of the previous application into one of the official languages of the EPO is required only if it is needed for determining the validity of the priority claim, where this is of relevance to the patentability of the underlying invention. The translation must be filed within the time limit set by the EPO. For more details on the procedure see A-III, 6.8 and sub-sections.

*Art. 88(1)*  
*Rule 53(3)*

Alternatively, under Rule 53(3), a declaration that the European patent application is a complete translation of the previous application may be submitted within that same time limit. This declaration must be unambiguous, stating that the translation is "complete" or, for example, "identical" or "literal". Declarations in diluted or modified form (stating, for example, that the translation is "practically complete" or that the contents "are essentially the same") cannot be accepted. The same applies to cases where the declaration is obviously incorrect (e.g. if several priorities are claimed for a single European application or if the European application contains more or less text than is contained in the previous application as filed). In all these cases a complete translation must be filed. Where the European application contains claims on its date of filing and the priority application did not contain claims on its filing date or contained fewer claims on its filing date than the subsequent European application, the declaration cannot be accepted. A merely different arrangement of the various elements of the application (e.g. presenting the claims before the description, or vice versa) does not affect the validity of such a declaration. See also A-III, 6.8.6.

The translation or declaration under Rule 53(3) must also be filed in those cases where the EPO adds a copy of the previous application to the file (see Notice from the EPO, OJ EPO 2002, 192).

If the applicant has already provided the EPO with a translation of the priority document as part of a request under Rule 56 (see A-II, 5.4(vi))

*Rule 56*

to base missing parts of the description or drawings on the priority application itself, then there is no need for the applicant to file the translation a second time.

The request for translation cannot be made by telephone (regardless of whether this is mentioned in the minutes). Because of the time limit and its possible legal consequences, the request must always be made in writing. In examination proceedings it may be issued alone or may accompany a communication under Art. 94(3). The translation of the priority document may become necessary only at later stages of the examination procedure, when documents are retrieved by carrying out a "topping-up" search for conflicting applications under Art. 54(3) (see C-IV, 7.1, and A-III, 6.8.2). This may also happen during opposition proceedings where the applicant was not requested to file the translation before grant and the opponent raises patentability issues which require examination of the validity of the priority.

If the required translation or declaration is not filed within the time limit, the right of priority is lost and the applicant or proprietor is informed accordingly (see A-III, 6.11). This has the effect that the intermediate document(s) which resulted in the validity of the priority claimed becoming relevant for the assessment of patentability will belong to the prior art under Art. 54(2) or (3), as applicable (see A-III, 6.8.3). However, for reasons of legal certainty the right of priority remains effective for determining the state of the art for the purposes of Art. 54(3) (see F-VI, 2.1 and 3.5) in respect of any other European patent application. In that respect it is immaterial whether the translation or declaration has been filed, as changes taking effect after the date of publication do not affect the application of Art. 54(3).

If the required translation or declaration is filed within the time limit, ideally with accompanying observations, the extent of the validity of the priority and the co-dependent substantive issues will be examined.

### **3.5 Abandonment of priority claim**

An applicant may voluntarily abandon a claimed priority at any time. If he does so before the technical preparations for publication have been completed, then the priority date is not effective and the publication is deferred until 18 months after the filing date. If it is abandoned after the technical preparations for publication have been completed, then the application is still published 18 months after the priority date originally claimed (see A-VI, 1.1 and G-IV, 5.1.1).

### **3.6 Re-establishment of rights in respect of the priority period**

An applicant may file a request for re-establishment of rights in respect of the priority period under Art. 122 (see A-III, 6.6). Any request for re-establishment of rights in respect of the period specified in Art. 87(1) must be filed within two months of expiry of that period, according to Rule 136(1), second sentence. Where a request for re-establishment in respect of the priority period has been allowed, the examiner should



carefully review the relevance of prior art documents cited previously in the search report or communications.



# **Part G**

## **Patentability**



## Contents

### Chapter I – Patentability I-1

- 1. Basic requirements I-1
- 2. Further requirements I-1
- 3. Technical progress, advantageous effects I-1

### Chapter II – Inventions II-1

- 1. General remarks II-1
- 2. Examination practice II-1
- 3. List of exclusions II-1
  - 3.1 Discoveries II-2
  - 3.2 Scientific theories II-2
  - 3.3 Mathematical methods II-2
  - 3.4 Aesthetic creations II-4
  - 3.5 Schemes, rules and methods for performing mental acts, playing games or doing business II-4
  - 3.6 Programs for computers II-5
  - 3.7 Presentations of information II-7
    - 3.7.1 User interfaces II-8
    - 3.7.2 Data retrieval, formats and structures II-8
- 4. Exceptions to patentability II-9
  - 4.1 Matter contrary to "*ordre public*" or morality II-9
    - 4.1.1 Prohibited matter II-9
    - 4.1.2 Offensive and non-offensive use II-10
    - 4.1.3 Economic effects II-10
  - 4.2 Surgery, therapy and diagnostic methods II-10
    - 4.2.1 Limitations of exception under Art. 53(c) II-11
      - 4.2.1.1 Surgery II-12
      - 4.2.1.2 Therapy II-13
      - 4.2.1.3 Diagnostic methods II-13
    - 4.2.2 Methods for screening potential medicaments and clinical trials II-15

<b>5.</b>	<b>Exclusions and exceptions for biotechnological inventions</b>	<b>II-15</b>
5.1	General remarks and definitions	II-15
5.2	Patentable biotechnological inventions	II-15
5.3	List of exceptions (Rule 28)	II-17
5.4	Plant and animal varieties, essentially biological processes for the production of plants or animals	II-18
5.4.1	Plant varieties	II-18
5.4.2	Essentially biological processes for the production of plants or animals	II-19
5.5	Microbiological processes	II-19
5.5.1	General remarks	II-19
5.5.2	Repeatability of results of microbiological processes	II-20

### **Chapter III – Industrial application** **III-1**

<b>1.</b>	<b>General remarks</b>	<b>III-1</b>
<b>2.</b>	<b>Method of testing</b>	<b>III-1</b>
<b>3.</b>	<b>Industrial application vs. exclusion under Art. 52(2)</b>	<b>III-1</b>
<b>4.</b>	<b>Sequences and partial sequences of genes</b>	<b>III-1</b>

### **Chapter IV – State of the art** **IV-1**

<b>1.</b>	<b>General remarks and definition</b>	<b>IV-1</b>
<b>2.</b>	<b>Enabling disclosures</b>	<b>IV-2</b>
<b>3.</b>	<b>Date of filing or priority date as effective date</b>	<b>IV-3</b>
<b>4.</b>	<b>Documents in a non-official language</b>	<b>IV-4</b>
4.1	Machine translations	IV-4
<b>5.</b>	<b>Conflict with other European applications</b>	<b>IV-4</b>
5.1	State of the art pursuant to Art. 54(3)	IV-4
5.1.1	Requirements	IV-5
5.1.2	Accorded date of filing still subject to review	IV-6
5.2	Euro-PCT applications	IV-6

5.3	Commonly designated States	IV-6
5.4	Double patenting	IV-6
<b>6.</b>	<b>Conflict with national rights of earlier date</b>	<b>IV-7</b>
<b>7.</b>	<b>State of the art made available to the public "by use or in any other way"</b>	<b>IV-7</b>
7.1	Types of use and instances of state of the art made available in any other way	IV-7
7.2	Matters to be determined by the Opposition Division as regards use	IV-8
7.2.1	General principles	IV-8
7.2.2	Agreement on secrecy	IV-9
7.2.3	Use on non-public property	IV-9
7.2.4	Example of the accessibility of objects used	IV-10
7.2.5	Example of the inaccessibility of a process	IV-10
7.3	State of the art made available by means of oral description	IV-10
7.3.1	Cases of oral description	IV-10
7.3.2	Non-prejudicial oral description	IV-10
7.3.3	Matters to be determined by the Opposition Division in cases of oral description	IV-11
7.4	State of the art made available to the public in writing or by any other means	IV-11
7.5	Internet disclosures	IV-11
7.5.1	Establishing the publication date	IV-11
7.5.2	Standard of proof	IV-12
7.5.3	Burden of proof	IV-13
7.5.3.1	Technical journals	IV-13
7.5.3.2	Other "print equivalent" publications	IV-14
7.5.3.3	Non-traditional publications	IV-14
7.5.4	Disclosures which have no date or an unreliable date	IV-15
7.5.5	Problematic cases	IV-16
7.5.6	Technical details and general remarks	IV-16
7.6	Standards and standard preparatory documents	IV-17
<b>8.</b>	<b>Cross-references between prior art documents</b>	<b>IV-18</b>
<b>9.</b>	<b>Errors in prior art documents</b>	<b>IV-18</b>
<b>Chapter V – Non-prejudicial disclosures</b>		<b>V-1</b>
<b>1.</b>	<b>General</b>	<b>V-1</b>

<b>2.</b>	<b>Time limit</b>	<b>V-1</b>
<b>3.</b>	<b>Evident abuse</b>	<b>V-1</b>
<b>4.</b>	<b>International exhibition</b>	<b>V-1</b>

## **Chapter VI – Novelty** **VI-1**

<b>1.</b>	<b>State of the art pursuant to Art. 54(2)</b>	<b>VI-1</b>
<b>2.</b>	<b>Implicit features or well-known equivalents</b>	<b>VI-1</b>
<b>3.</b>	<b>Relevant date of a prior document</b>	<b>VI-1</b>
<b>4.</b>	<b>Enabling disclosure of a prior document</b>	<b>VI-2</b>
<b>5.</b>	<b>Generic disclosure and specific examples</b>	<b>VI-2</b>
<b>6.</b>	<b>Implicit disclosure and parameters</b>	<b>VI-2</b>
<b>7.</b>	<b>Examination of novelty</b>	<b>VI-3</b>
7.1	Second or further medical use of known pharmaceutical products	VI-3
7.1.1	Products that may be claimed for a further medical use	VI-5
7.1.2	Therapeutic uses pursuant to Art. 54(5)	VI-5
7.1.3	Diagnostic uses pursuant to Art. 54(5)	VI-7
7.1.4	Surgical uses pursuant to Art. 54(5)	VI-8
7.1.5	Dependent claims pursuant to Art. 54(5)	VI-9
7.2	Second non-medical use	VI-10
<b>8.</b>	<b>Selection inventions</b>	<b>VI-10</b>
8.1	Error margins in numerical values	VI-12
<b>9.</b>	<b>Novelty of "reach-through" claims</b>	<b>VI-12</b>

## **Chapter VII – Inventive step** **VII-1**

<b>1.</b>	<b>General</b>	<b>VII-1</b>
<b>2.</b>	<b>State of the art; date of filing</b>	<b>VII-1</b>
<b>3.</b>	<b>Person skilled in the art</b>	<b>VII-1</b>
3.1	Common general knowledge of the skilled person	VII-2
<b>4.</b>	<b>Obviousness</b>	<b>VII-2</b>



---

<b>5.</b>	<b>Problem-and-solution approach</b>	<b>VII-3</b>
5.1	Determination of the closest prior art	VII-3
5.2	Formulation of the objective technical problem	VII-4
5.3	Could-would approach	VII-5
5.4	Claims comprising technical and non-technical aspects	VII-6
5.4.1	"Requirements specification" in the formulation of the objective technical problem	VII-7
<b>6.</b>	<b>Combining pieces of prior art</b>	<b>VII-7</b>
<b>7.</b>	<b>Combination vs. juxtaposition or aggregation</b>	<b>VII-8</b>
<b>8.</b>	<b>"Ex post facto" analysis</b>	<b>VII-9</b>
<b>9.</b>	<b>Origin of an invention</b>	<b>VII-10</b>
<b>10.</b>	<b>Secondary indicators</b>	<b>VII-10</b>
10.1	Predictable disadvantage; non-functional modification; arbitrary choice	VII-10
10.2	Unexpected technical effect; bonus effect	VII-11
10.3	Long-felt need; commercial success	VII-11
<b>11.</b>	<b>Arguments and evidence submitted by the applicant</b>	<b>VII-11</b>
<b>12.</b>	<b>Selection inventions</b>	<b>VII-12</b>
<b>13.</b>	<b>Dependent claims; claims in different categories</b>	<b>VII-12</b>
<b>14.</b>	<b>Examples</b>	<b>VII-13</b>
<b>Annex</b>	<b>Examples relating to the requirement of inventive step – indicators</b>	<b>VII-14</b>



## Chapter I – Patentability

### 1. Basic requirements

There are four basic requirements for patentability:

*Art. 52(1)*

- (i) there must be an "invention", belonging to any field of technology (see G-II);
- (ii) the invention must be "susceptible of industrial application" (see G-III);
- (iii) the invention must be "new" (see G-IV to VI); and
- (iv) the invention must involve an "inventive step" (see G-VII).

### 2. Further requirements

In addition to these four basic requirements, the examiner should be aware of the following two requirements that are implicitly contained in the EPC:

- (i) the invention must be such that it can be carried out by a person skilled in the art (after proper instruction by the application); this follows from Art. 83. Instances where the invention fails to satisfy this requirement are given in F-III, 3; and

*Art. 83*

- (ii) the invention must be of "technical character" to the extent that it must relate to a technical field (Rule 42(1)(a)), must be concerned with a technical problem (Rule 42(1)(c)), and must have technical features in terms of which the matter for which protection is sought can be defined in the claim (Rule 43(1)) (see F-IV, 2.1).

*Rule 42(1)(a) and (c)*  
*Rule 43(1)*

### 3. Technical progress, advantageous effects

The EPC does not require explicitly or implicitly that an invention, to be patentable, must entail some technical progress or even any useful effect. Nevertheless, advantageous effects, if any, with respect to the state of the art should be stated in the description (Rule 42(1)(c)), and any such effects are often important in determining "inventive step" (see G-VII, 5).



## Chapter II – Inventions

### 1. General remarks

The EPC does not define what is meant by "invention", but Art. 52(2) contains a non-exhaustive list of things which are not regarded as inventions. It will be noted that the items on this list are all either abstract (e.g. discoveries or scientific theories) and/or non-technical (e.g. aesthetic creations or presentations of information). In contrast to this, an "invention" within the meaning of Art. 52(1) must be of both a concrete and a technical character (see G-I, 2(ii)). It may be in any field of technology.

*Art. 52(2) and (3)*

### 2. Examination practice

In considering whether the subject-matter of an application is an invention within the meaning of Art. 52(1), there are two general points the examiner must bear in mind. Firstly, any exclusion from patentability under Art. 52(2) applies only to the extent to which the application relates to the excluded subject-matter as such (Art. 52(3)). Secondly, the subject-matter of the claim should be considered as a whole, in order to decide whether the claimed subject-matter has a technical character. If it does not, there is no invention within the meaning of Art. 52(1).

It must also be borne in mind that the basic test of whether there is an invention within the meaning of Art. 52(1) is separate and distinct from the questions whether the subject-matter is susceptible of industrial application, is new and involves an inventive step. Technical character should be assessed without regard to the prior art (see T 1173/97, confirmed by G 3/08).

It should be noted that the assessment of technical character should not stop as soon as it has been established that the claim as a whole is not excluded from patentability under Art. 52(2) and (3). In claims comprising technical and non-technical aspects, each aspect has to be evaluated to see if it contributes to the technical character of the claimed subject-matter, since this is relevant for assessing inventive step (see G-VII, 5.4).

Where it is found that the claims relate in part to excluded subject-matter, this may have led to the issuing of a partial European or supplementary European search report under Rule 63 (see B-VIII, 1, 3.1 and 3.2). In such cases, in the absence of appropriate amendment and/or convincing arguments provided by the applicant in his response to the invitation under Rule 63(1) (see B-VIII, 3.2) or to the search opinion under Rule 70a (see B-XI,8), an objection under Rule 63(3) will also arise (see H-II, 5).

### 3. List of exclusions

The items on the list in Art. 52(2) will now be dealt with in turn, and further examples will be given in order better to clarify the distinction

between what is patentable in the sense of not being excluded from patentability under Art. 52(2) and (3) and what is not.

### 3.1 Discoveries

*Art. 52(2)(a)*

If a new property of a known material or article is found out, that is mere discovery and unpatentable because discovery as such has no technical effect and is therefore not an invention within the meaning of Art. 52(1). If, however, that property is put to practical use, then this constitutes an invention which may be patentable. For example, the discovery that a particular known material is able to withstand mechanical shock would not be patentable, but a railway sleeper made from that material could well be patentable. To find a previously unrecognised substance occurring in nature is also mere discovery and therefore unpatentable. However, if a substance found in nature can be shown to produce a technical effect, it may be patentable. An example of such a case is that of a substance occurring in nature which is found to have an antibiotic effect. In addition, if a microorganism is discovered to exist in nature and to produce an antibiotic, the microorganism itself may also be patentable as one aspect of the invention. Similarly, a gene which is discovered to exist in nature may be patentable if a technical effect is revealed, e.g. its use in making a certain polypeptide or in gene therapy.

For further specific issues concerning biotechnological inventions see G-II, 5, 5.3 to 5.5, and G-III, 4.

### 3.2 Scientific theories

*Art. 52(2)(a)*

These are a more generalised form of discoveries, and the same principle as set out in G-II, 3.1 applies. For example, the physical theory of semiconductivity would not be patentable. However, new semiconductor devices and processes for manufacturing these may be patentable.

### 3.3 Mathematical methods

*Art. 52(2)(a)*

These are a particular example of the principle that purely abstract or intellectual methods are not patentable. For example, an abstract shortcut method of division would be excluded from patentability by Art. 52(2)(a) and (3). However, a calculating machine constructed to operate accordingly (e.g. by executing a program designed to carry out the method) would not be excluded. Electrical filters designed according to a particular mathematical method would also not be excluded.

Furthermore, a method for analysing the cyclical behaviour of a curve relating two parameters, which are not further specified, to one another is a mathematical method as such, excluded from patentability by Art. 52(2)(a) and (3), unless it uses technical means, for example, if it is computer-implemented.

A claim directed to a technical process in which a mathematical method is used, thus being restricted to a particular application of the

mathematical method in a technical field, does not seek protection for the mathematical method as such. For instance, a method of encoding audio information in a communication system may aim to reduce distortion induced by channel noise. Although the idea underlying such a method may be considered to reside in a mathematical method, the encoding method as a whole is not a mathematical method as such, and hence is not excluded from patentability by Art. 52(2)(a) and (3). Similarly, a method of encrypting/decrypting or signing electronic communications may be regarded as a technical method, even if it is essentially based on a mathematical method (see T 1326/06).

A procedural step (e.g. a mathematical algorithm) may contribute to the technical character of a claimed method only if it serves an adequately defined technical purpose of the method. In particular, specific technical applications of computer-implemented simulation methods, even if involving mathematical formulae, are to be regarded as modern technical methods which form an essential part of the fabrication process. Such simulation methods cannot be denied a technical effect merely on the ground that they do not yet incorporate the physical end product. However, the meta-specification of an undefined technical purpose (for example, the simulation of a "technical system"), could not be considered adequate (T 1227/05).

In a mathematical method for processing data, although defining the origin of the data records, i.e. what the data represents, may imply technical aspects, it does not necessarily confer technical character upon the method. For example, in a mathematical method for classifying data records, the classification algorithm would not derive a technical character from specifying that the data records are assembled from events in a telecommunications network if the classification is not performed for a technical purpose. What is also decisive is whether a technical effect is achieved by the functional nature of the data irrespective of its cognitive content (see T 1194/97, T 1161/04). For example, a mathematical method for processing data representing an image stored as an electric signal by a computer-implemented method and providing as its result a certain change in the image (e.g. restoring the image if it is distorted) is considered as being used in a technical process (T 208/84 and T 1161/04).

The increased speed or efficiency of a method based on improved algorithms is not sufficient on its own to establish a technical character of the method (see T 1227/05). Characteristics such as speed and efficiency are inherent in both technical and non-technical methods. For example, if a sequence of auction steps leads to price determination more quickly than some other auction method, that does not necessarily imply that the auction steps contribute to the technical character of the method (see T 258/03).

### 3.4 Aesthetic creations

*Art. 52(2)(b)*

Subject-matter relating to aesthetic creations will usually have both technical aspects, e.g. a 'substrate' such as a canvas or a cloth, and aesthetic aspects, the appreciation of which is essentially subjective, e.g. the form of the image on the canvas or the pattern on the cloth. If technical aspects are present in such an aesthetic creation, it is not an aesthetic creation 'as such' and it is not excluded from patentability.

A feature which might not reveal a technical aspect when taken by itself could have a technical character if it brings about a technical effect. For example, the pattern of a tyre tread may actually be a further technical feature of the tyre if, for example, it provides improved channelling of water. On the contrary, this would not be the case when a particular colour of the sidewall of the tyre serves only an aesthetic purpose.

The aesthetic effect itself is not patentable, neither in a product nor in a process claim.

For example, features relating solely to the aesthetic or artistic effect of the information content of a book, or to its layout or letterfont, would not be considered as technical features. Neither would features such as the aesthetic effect of the subject of a painting or the arrangement of its colours or its artistic (e.g. Impressionist) style be technical. Nevertheless, if an aesthetic effect is obtained by a technical structure or other technical means, although the aesthetic effect itself is not of a technical character, the means of obtaining it may be. For example, a fabric may be provided with an attractive appearance by means of a layered structure not previously used for this purpose, in which case a fabric incorporating such structure might be patentable.

Similarly, a book defined by a technical feature of the binding or pasting of the back is not excluded from patentability under Art. 52(2) and (3), even though it has an aesthetic effect too. A painting defined by the kind of cloth, or by the dyes or binders used, is likewise not excluded.

A technical process, even if it is used to produce an aesthetic creation (such as a cut diamond), is nevertheless a technical process which is not excluded from patentability. Similarly, a printing technique for a book resulting in a particular layout with aesthetic effect is not excluded, and nor is the book as a product of that process. Again, a substance or composition defined by technical features serving to produce a special effect with regard to scent or flavour, e.g. to maintain a scent or flavour for a prolonged period or to accentuate it, is not excluded.

*Art. 52(2)(c)*

### 3.5 Schemes, rules and methods for performing mental acts, playing games or doing business

These are further examples of items of an abstract or intellectual character. In particular, a scheme for learning a language, a method of



solving crossword puzzles, a game (as an abstract entity defined by its rules), modelling information or a scheme for organising a commercial operation would not be patentable. A method of doing business is excluded from patentability even where it implies the possibility of making use of unspecified technical means or has practical utility (see T 388/04). Another example is that of a method for designing a nuclear core loading arrangement, which neither specifies the use of means or measures of a technical nature nor includes the provision of a physical entity as the resulting product (e.g. a reactor core loaded according to the given design). This method may exclusively be carried out mentally and thus lacks technical character, regardless of the complexity of the method or any technical considerations involved (see T 914/02).

However, if the claimed subject-matter specifies an apparatus or a technical process for carrying out at least some part of the scheme, that scheme and the apparatus or process have to be examined as a whole. In particular, if the claim specifies computers, computer networks or other conventional programmable apparatus, a program therefor, or a storage medium carrying the program, for executing at least some steps of a scheme, it may comprise a mix of technical and non-technical features, with the technical features directed to a computer or a comparable programmed device. In these cases, the claim is to be examined as a "computer-implemented invention" (see below).

### 3.6 Programs for computers

Art. 52(2)(c)

Inventions involving programs for computers can be protected in different forms of a "computer-implemented invention", an expression intended to cover claims which involve computers, computer networks or other programmable apparatus whereby *prima facie* one or more of the features of the claimed invention are realised by means of a program or programs. Such claims directed at computer-implemented inventions may e.g. take the form of a method of operating said apparatus, the apparatus set up to execute the method, or, following T 1173/97, the computer program itself as well as the physical media carrying the program (see T 424/03), i.e. computer program product claims, such as "data carrier", "storage medium", "computer readable medium" or "signal".

The category of a claim directed to a computer-implemented method is distinguished from that of a claim directed to a computer program corresponding to that method (T 424/03 and G 3/08). Such claims therefore have to be examined separately.

Technical character should be assessed without regard to the prior art (see T 1173/97, confirmed by G 3/08). Features of the computer program itself (see T 1173/97) as well as the presence of a device defined in the claim (see T 424/03 and T 258/03) may potentially lend technical character to the claimed subject-matter as explained below. In particular in embedded systems, a data processing operation

implemented by means of a computer program can equally be implemented by means of special circuits (e.g. by field-programmable gate arrays).

The basic patentability considerations in respect of claims for computer programs are in principle the same as for other subject-matter. While "programs for computers" are included among the items listed in Art. 52(2), if the claimed subject-matter has a technical character it is not excluded from patentability by the provisions of Art. 52(2) and (3).

A computer program claimed by itself is not excluded from patentability if it is capable of bringing about, when running on or loaded into a computer, a further technical effect going beyond the "normal" physical interactions between the program (software) and the computer (hardware) on which it is run (T 1173/97 and G 3/08). The normal physical effects of the execution of a program, e.g. electrical currents, are not in themselves sufficient to lend a computer program technical character, and a further technical effect is needed. The further technical effect may be known in the prior art.

Likewise, although it may be said that all computer programming involves technical considerations since it is concerned with defining a method which can be carried out by a machine, that in itself is not enough to demonstrate that the program which results from the programming has technical character; the programmer must have had technical considerations beyond "merely" finding a computer algorithm to carry out some procedure (G 3/08).

A further technical effect which lends technical character to a computer program may be found e.g. in the control of an industrial process or in the internal functioning of the computer itself or its interfaces under the influence of the program and could, for example, affect the efficiency or security of a process, the management of computer resources required or the rate of data transfer in a communication link. A computer program implementing a mathematical method that itself makes a technical contribution (see G-II, 3.3) would also be considered to be capable of bringing about a further technical effect when it is run on a computer.

A patent may be granted on one of the different forms of a computer program product claim if all the requirements of the EPC are met; see in particular Art. 84, 83, 54 and 56, and G-III, 3 below. Such claims should not contain program listings, but should define all the features which assure patentability of the process which the program is intended to carry out when it is run (see F-IV, 4.5.2, last sentence). Short excerpts from programs might be accepted in the description (see F-II, 4.12).

Whether a computer program can contribute to the technical character of the claimed subject-matter is frequently an issue separate and distinct from the technical character of the hardware components



which may be defined in order to execute the computer program. When a computer program produces a further technical effect (T 1173/97), it is by itself considered technical and not excluded. In contrast, any claimed subject-matter defining or using technical means is an invention within the meaning of Art. 52(1) (see T 424/03 and T 258/03, and confirmed in G 3/08). This applies even if the technical means are commonly known; for example, the inclusion of a computer, a computer network, a readable medium carrying a program, etc. in a claim lends technical character to the claimed subject-matter.

If claimed subject-matter relating to a computer program does not have a technical character, it should be rejected under Art. 52(2) and (3). If the subject-matter passes this test for technicality, the examiner should then proceed to the questions of novelty and inventive step (see G-VI and VII).

### 3.7 Presentations of information

Art. 52(2)(d)

A feature relating to a presentation of information defined solely by the content of the information does not have a technical character. This applies whether the feature is claimed as a presentation of the information *per se* (e.g. by acoustical signals, spoken words, visual displays, books defined by their subject, gramophone records defined by the musical piece recorded, traffic signs defined by the warning thereon) or as relating to processes and apparatus for presenting information (e.g. features of indicators or recorders defined solely by the information indicated or recorded would not be technical features).

A feature which relates to the manner in which cognitive content is conveyed to the user on a screen normally does not contribute to a technical solution to a technical problem. An exception would be if the arrangement or manner of presentation can be shown to have a credible technical effect (T 1741/08, T 1143/06).

Examples in which such a technical feature may be present are: a telegraph apparatus or communication system using a particular code to represent the characters (e.g. pulse code modulation); a measuring instrument designed to produce a particular form of graph for representing the measured information; a gramophone record having a particular groove form to allow stereo recordings; a computer data structure (see T 1194/97) defined in terms which inherently comprise the technical features of the program which operates on said data structure (assuming the program itself, in the particular case, to be patentable); and a diapositive with a soundtrack arranged at the side of it.

When assessing the exclusion from patentability under Art. 52(2), the subject-matter of the claim has to be considered as a whole (G-II, 2). For example, a claim directed to a product (e.g. a bleaching composition) and to instructions for use of the product, wherein the instructions have no technical effect on the product, is not excluded since the claim has a technical meaning and defines the technical

features necessary for the definition of the claimed subject-matter, i.e. a product comprising a composition of matter (T 553/02).

When deciding if a feature relating to the presentation of information is technical or not, what has to be considered is whether or not it contributes to solving a technical problem. The fact that mental activities are involved does not on its own render the subject-matter non-technical (T 643/00). However, a feature that solely addresses a user's subjective preferences does not solve a technical problem (T 1567/05). In the context of automated systems, in particular computers, giving visual indications of an automatically detected event occurring in the system itself as a prompt for human interaction with the system, e.g. to avoid technical malfunctions, is usually regarded as making a technical contribution. On the other hand, a visual indication aimed exclusively at the mental activities of the viewer, in particular at preparing the relevant data for a non-technical decision-making process by the user as the final addressee, is usually not regarded as making a technical contribution (T 756/06). Presenting the state of some non-technical application executed on a computer is normally not considered to be technical, either.

### 3.7.1 User interfaces

Features concerning the graphic design of user interfaces do not have a technical effect, because their design is not based on technical considerations, but on general intellectual considerations as to which design is particularly appealing to a user.

For example, the colour, shape, size, layout, arrangement of items on the screen or the information content of a message displayed is usually not a technical aspect of a graphical user interface.

However, the examiner must check whether these features contribute to achieving a particular technical effect if, e.g.:

- they are combined with steps of or means for interacting with a user or
- they concern technical information (e.g. internal machine states).

### 3.7.2 Data retrieval, formats and structures

A computer-implemented data structure (see T 1194/97) or a computer-implemented data format embodied on a medium or as an electromagnetic carrier wave has technical character (because the storage medium is a technical artefact) and thus is an invention in the sense of Art. 52(1). Such data structures or formats may comprise a mixture of cognitive content and functional data.

Technical effects associated with data structures or formats when using said data structure or format during the operation of a computer system could give rise to, for example: efficient data processing,

efficient data storage, enhanced security. On the other hand, features merely describing data collections on a logical level do not provide a technical effect, even if such a description might involve a particular modelling of the described data.

A data structure in itself is merely a static memory configuration. Therefore, when a data structure is claimed by itself, a technical effect cannot be directly identified since there is no method being carried out. Furthermore, a claimed data structure can potentially be used in combination with different algorithms or methods for completely different purposes.

For these reasons the examiner should check whether the data structure as claimed inherently comprises the technical features of the system or the steps of a corresponding method which forms the basis of the technical effect.

#### 4. Exceptions to patentability

##### 4.1 Matter contrary to "*ordre public*" or morality

Any invention the commercial exploitation of which would be contrary to "*ordre public*" or morality is specifically excluded from patentability. The purpose of this is to deny protection to inventions likely to induce riot or public disorder, or to lead to criminal or other generally offensive behaviour (see also F-II, 7.2). Anti-personnel mines are an obvious example. This provision is likely to be invoked only in rare and extreme cases. A fair test to apply is to consider whether it is probable that the public in general would regard the invention as so abhorrent that the grant of patent rights would be inconceivable. If it is clear that this is the case, objection should be raised under Art. 53(a); otherwise not. The mere possibility of abuse of an invention is not sufficient to deny patent protection pursuant to Art. 53(a) EPC if the invention can also be exploited in a way which does not and would not infringe "*ordre public*" and morality (see T 866/01). If difficult legal questions arise in this context, then refer to C-VIII, 7.

Art. 53(a)

Where it is found that the claims relate in part to such excluded subject-matter, this may have led to the issuing of a partial European or supplementary European search report under Rule 63 (see B-VIII, 1, 3.1 and 3.2). In such cases, in the absence of appropriate amendment and/or convincing arguments provided by the applicant in his response to the invitation under Rule 63(1) (see B-VIII, 3.2) or to the search opinion under Rule 70a (see B-XI, 8), an objection under Rule 63(3) will also arise (see H-II, 5).

##### 4.1.1 Prohibited matter

Exploitation is not to be deemed to be contrary to "*ordre public*" or morality merely because it is prohibited by law or regulation in some or all of the Contracting States. One reason for this is that a product could still be manufactured under a European patent for export to States in which its use is not prohibited.

Art. 53(a)

#### 4.1.2 Offensive and non-offensive use

Special attention should be paid to applications in which the invention has both an offensive and a non-offensive use, e.g. a process for breaking open locked safes, the use by a burglar being offensive but the use by a locksmith in the case of emergency non-offensive. In such a case, no objection arises under Art. 53(a). Similarly, if a claimed invention defines a copying machine with features resulting in an improved precision of reproduction and an embodiment of this apparatus could comprise further features (not claimed but apparent to the skilled person) the only purpose of which would be that it should also allow reproduction of security strips in banknotes strikingly similar to those in genuine banknotes, the claimed apparatus would cover an embodiment for producing counterfeit money which could be considered to fall under Art. 53(a). There is, however, no reason to consider the copying machine as claimed to be excluded from patentability, since its improved properties could be used for many acceptable purposes (see G 1/98, Reasons 3.3.3). However, if the application contains an explicit reference to a use which is contrary to "*ordre public*" or morality, deletion of this reference should be required under the terms of Rule 48(1)(a).

#### 4.1.3 Economic effects

The EPO has not been vested with the task of taking into account the economic effects of the grant of patents in specific areas of technology and of restricting the field of patentable subject-matter accordingly (see G 1/98 Reasons 3.9, and T 1213/05). The standard to apply for an exception under Art. 53(a) is whether the commercial exploitation of the invention is contrary to "*ordre public*" or morality.

#### 4.2 Surgery, therapy and diagnostic methods

Art. 53(c)

European patents are not to be granted in respect of "methods for treatment of the human or animal body by surgery or therapy and diagnostic methods practised on the human or animal body; this provision shall not apply to products, in particular substances or compositions, for use in any of these methods." Hence, patents may be obtained for surgical, therapeutic or diagnostic instruments or apparatuses for use in such methods. The manufacture of prostheses or artificial limbs could be patentable. For instance, a method of manufacturing insoles in order to correct the posture or a method of manufacturing an artificial limb should be patentable. In both cases, taking the imprint of the footplate or a moulding of the stump on which an artificial limb is fitted is clearly not of a surgical nature and does not require the presence of a medically qualified person. Furthermore, the insoles as well as the artificial limb are manufactured outside the body. However, a method of manufacturing an endoprosthesis outside the body, but requiring a surgical step to be carried out for taking measurements, would be excluded from patentability under Art. 53(c) (see T 1005/98).

Art. 54(4)

Patents may be obtained for **new** products, particularly substances or compositions, for use in these methods of treatment or diagnosis.

According to Art. 54(4), where the substance or composition is known, it may only be patented for use in these methods if the known substance or composition was not previously disclosed for use in surgery, therapy or diagnostic methods practised on the human or animal body ("**first medical use**"). A claim to a known substance or composition for the first use in surgical, therapeutic and/or diagnostic methods should be in a form such as: "Substance or composition X" followed by the indication of the use, for instance "... for use as a medicament" or "... for use in therapy/diagnostics/surgery". If the known substance or composition was previously disclosed for use in surgery, therapy or diagnostic methods practised on the human or animal body ("**further medical use**"), the claim should be in the form: "Substance or composition X" followed by the indication of the **specific** therapeutical/diagnostic/surgical use, for instance, "... for use in treating disease Y" (see G-VI, 7.1).

#### 4.2.1 Limitations of exception under Art. 53(c)

It should be noted that the exceptions under Art. 53(c) are confined to methods for treatment of the human or animal body by surgery or therapy and diagnostic methods practised on the human or animal body. It follows that other methods of treatment of live human beings or animals (e.g. treatment of a sheep in order to promote growth, to improve the quality of mutton or to increase the yield of wool) or other methods of measuring or recording characteristics of the human or animal body are patentable, provided that (as would probably be the case) such methods are of a technical and not essentially biological character (see G-II, 5.4). For example, an application containing claims directed to the purely cosmetic treatment of a human by administration of a chemical product is considered as being patentable (see T 144/83). A cosmetic treatment involving surgery or therapy would, however, not be patentable (see below).

*Art. 53(c)*

To be excluded from patentability, a treatment or diagnostic method must actually be carried out on the living human or animal body. A treatment or diagnostic method practised on a dead human or animal body would therefore not be excluded from patentability by virtue of Art. 53(c). Treatment of body tissues or fluids after they have been removed from the human or animal body, or diagnostic methods applied thereon, are not excluded from patentability insofar as these tissues or fluids are not returned to the same body. Thus the treatment of blood for storage in a blood bank or diagnostic testing of blood samples is not excluded, whereas a treatment of blood by dialysis with the blood being returned to the same body would be excluded.

Regarding methods which are carried out on or in relation to the living human or animal body, it should be borne in mind that the intention of Art. 53(c) is only to free from restraint non-commercial and non-industrial medical and veterinary activities. Interpretation of the provision should avoid the exceptions from going beyond their proper limits (see G 5/83, G 1/04, and G 1/07).

Whether or not a method is excluded from patentability under Art. 53(c) cannot depend on the person carrying it out (see G 1/04 and G 1/07, Reasons 3.4.1).

However, in contrast to the subject-matter referred to in Art. 52(2) and (3) which is only excluded from patentability if claimed as such, a method claim is not allowable under Art. 53(c) if it includes at least one feature defining a physical activity or action that constitutes a method step for treatment of the human or animal body by surgery or therapy. In that case, whether or not the claim includes or consists of features directed to a technical operation performed on a technical object is legally irrelevant to the application of Art. 53(c) (see G 1/07, Reasons 3.2.5).

#### **4.2.1.1 Surgery**

The meaning of the term "treatment by surgery" is not to be interpreted as being confined to surgical methods pursuing a therapeutic purpose (see G 1/07, Reasons 3.3.10). Accordingly, the term "surgery" defines the nature of the treatment rather than its purpose. Thus, for example, a method of treatment by surgery for cosmetic purposes or for embryo transfer is excluded from patentability, as well as surgical treatment for therapeutic purposes. The term "treatments by surgery" further covers interventions performed on the structure of an organism by conservative ("closed, non-invasive") procedures such as repositioning or by operative (invasive) procedures using instruments.

Whether a claimed method is to be considered as surgical treatment excluded from patentability under Art. 53(c) should be assessed on a case-by-case basis, taking the individual merits of each case into account. The aim of Art. 53(c) is that medical and veterinary practitioners should be free to use their skills and knowledge of the best available treatments to achieve the utmost benefit for their patients uninhibited by any worry that some treatment might be covered by a patent (see G 1/07, Reasons 3.3.6).

Thus, any definition of the term "treatment by surgery" must cover the kind of interventions which constitute the core of the medical profession's activities i.e. the kind of interventions for which their members are specifically trained and for which they assume a particular responsibility (G 1/07, Reasons 3.4.2.3).

The exclusion applies to substantial physical interventions on the body which require professional medical expertise to be carried out and which entail a substantial health risk even when carried out with the required professional care and expertise. The health risk must be associated with the mode of administration and not solely with the agent as such (G 1/07, Reasons 3.4.2.3). Examples of excluded treatments by surgery are the injection of a contrast agent into the heart, catheterisation and endoscopy.



Invasive techniques of a routine character which are performed on uncritical body parts and are generally carried out in a non-medical, commercial environment, are not excluded from patentability, e.g. tattooing, piercing, hair removal by optical radiation and micro-abrasion of the skin.

Similar considerations apply to routine interventions in the medical field. Thus, uncritical methods involving only a minor intervention and no substantial health risks, when carried out with the required care and skill, do not fall under the scope of Art. 53(c). This narrower understanding of the exclusion still protects the medical profession from the concerns indicated above.

The required medical expertise and the health risk involved may however not be the only criteria which may be used to determine that a claimed method actually constitutes "treatment by surgery" within the meaning of Art. 53(c). Other criteria, such as the degree of invasiveness or the complexity of the operation performed, could also determine that a physical intervention on the human or animal body constitutes such treatment (see G 1/07, Reasons 3.4.2.4).

The exclusion under Art. 53(c) applies to multi-step methods which comprise or encompass at least one therapeutic or surgical step, as defined in the previous paragraph. The non-patentable subject-matter must be removed from the scope of the claim. This may be done either by means of a disclaimer or by omitting the surgical step from the wording of the claim. The overall patentability of the amended claim will however depend on its compliance with the other requirements of the EPC, which should be assessed on a case-by-case basis.

Finally, when interpreting the scope of the exclusion under Art. 53(c), no distinction is to be made between human beings and animals.

#### **4.2.1.2 Therapy**

Therapy implies the curing of a disease or malfunction of the body and covers prophylactic treatment, e.g. immunisation against a certain disease (see T 19/86) or the removal of plaque (see T 290/86). A method for therapeutic purposes concerning the functioning of an apparatus associated with a living human or animal body is not excluded from patentability if no functional relationship exists between the steps related to the apparatus and the therapeutic effect of the apparatus on the body (see T 245/87).

As clinical trials have a therapeutic aspect for the human subjects undergoing them, an objection under Art. 53(c) should be raised if a claim includes a step relating to a method of treatment of the human body by therapy (see G-II, 4.2.2).

#### **4.2.1.3 Diagnostic methods**

Diagnostic methods likewise do not cover all methods related to diagnosis. To determine whether a claim is directed to a diagnostic

method within the meaning of Art. 53(c), it must first be established whether all of the necessary phases are included in the claim (G 1/04).

The claim must include method steps relating to **all** of the following phases:

- (i) the **examination phase**, involving the collection of data,
- (ii) the **comparison** of these data with standard values,
- (iii) the **finding of any significant deviation**, i.e. a symptom, during the comparison,
- (iv) the attribution of the deviation to a particular clinical picture, i.e. the deductive medical or veterinary **decision phase** (diagnosis for curative purposes *stricto sensu*).

If features pertaining to any of these phases are missing and are essential for the definition of the invention, those features are to be included in the independent claim (see Example 9 in Annex II of F-IV). Due account should be taken of steps which may be considered to be implicit: for example, steps relating to the comparison of data with standard values (phase (ii)) may imply the finding of a significant deviation (phase (iii) - see T 1197/02). The deductive medical or veterinary decision phase (iv), i.e. the "diagnosis for curative purposes *stricto sensu*", is the determination of the nature of a medical or veterinary medicinal condition intended to identify or uncover a pathology; the identification of the underlying disease is not required (see T 125/02).

It is then necessary to establish which of the method steps have **technical character**. The final phase (iv), for example, is normally a purely intellectual exercise (unless a device capable of reaching the diagnostic conclusions can be used) and therefore not technical in character.

In order to fulfil the "practised on the human or animal body" criterion, **each of the preceding technical method steps relating to phases (i) to (iii) must be performed on a human or animal body**. So, for each technical method step, it must be ascertained whether an interaction with the human or animal body takes place. The type or intensity of the interaction is not decisive: this criterion is fulfilled if the performance of the technical method step in question necessitates the presence of the body. Direct physical contact with the body is not required.

It is noted that a medical or veterinary practitioner does not have to be involved, either by being present or by bearing the overall responsibility, in the procedure.

If all of the above criteria are satisfied, then the claim defines a diagnostic method practised on the human or animal body, and an objection will be raised under Art. 53(c).

Accordingly, methods for merely obtaining information (data, physical quantities) from the living human or animal body (e.g. X-ray investigations, MRI studies, and blood pressure measurements) are not excluded from patentability under Art. 53(c).

#### **4.2.2 Methods for screening potential medicaments and clinical trials**

The scope of protection of a claim directed to a standard compound screening test carried out on "animals" encompasses preclinical tests carried out with libraries of compounds on human beings. In order for such a claim to be allowable under Art. 53(a), the use of human beings as "test animals" should be clearly excluded from the scope of the claim, e.g. by means of a disclaimer.

*Art. 53(a)*

In some infrequent cases, a claim may, in the light of the description, be interpreted as exclusively relating to a clinical trial of an experimental medicament carried out on human beings. Such trials are ethically acceptable, since they are performed under strictly controlled conditions and with informed consent of the patient concerned. Therefore, no objection under Art. 53(a) should be raised (see however G-II, 4.2.1.2).

### **5. Exclusions and exceptions for biotechnological inventions**

#### **5.1 General remarks and definitions**

"Biotechnological inventions" are inventions which concern a product consisting of or containing biological material or a process by means of which biological material is produced, processed or used. "Biological material" means any material containing genetic information and capable of reproducing itself or being reproduced in a biological system.

*Rule 26(2) and (3)*

#### **5.2 Patentable biotechnological inventions**

In principle, biotechnological inventions are patentable under the EPC. For European patent applications and patents concerning biotechnological inventions, the relevant provisions of the EPC are to be applied and interpreted in accordance with the provisions of Rules 26 to 29. European Union Directive 98/44/EC of 6 July 1998 on the legal protection of biotechnological inventions (OJ EPO 1999, 101) is to be used as a supplementary means of interpretation. In particular the recitals (abbreviated as rec.) preceding the provisions of the Directive are also to be taken into account.

*Rule 27  
Rule 26(1)*

Biotechnological inventions are also patentable if they concern an item on the following non-exhaustive list:

*Rule 27(a)*

- (i) Biological material which is **isolated** from its natural environment or produced by means of a technical process even if it previously occurred in nature

Hence, biological material may be considered patentable even if it already occurs in nature (see also G-II, 3.1).

*Rule 29(1) and (2)*

Although the human body, at the various stages of its formation and development, and the simple discovery of one of its elements, including the sequence or partial sequence of a gene, cannot constitute patentable inventions (see G-II, 5.3), an element isolated from the human body or otherwise produced by means of a technical process, which is susceptible of industrial application, including the sequence or partial sequence of a gene, may constitute a patentable invention, even if the structure of that element is identical to that of a natural element. Such an element is not a priori excluded from patentability since it is, for example, the result of technical processes used to identify, purify and classify it and to produce it outside the human body, techniques which human beings alone are capable of putting into practice and which nature is incapable of accomplishing itself (EU Dir. 98/44/EC, rec. 21).

*Rule 29(3)*

The examination of a patent application or a patent for gene sequences or partial sequences should be subject to the same criteria of patentability as in all other areas of technology (EU Dir. 98/44/EC, rec. 22). The industrial application of a sequence or partial sequence must be disclosed in the patent application as filed (see G-III, 4);

*Rule 27(b)*

- (ii) Plants or animals if the technical feasibility of the invention is not confined to a particular plant or animal variety

Inventions which concern plants or animals are patentable provided that the application of the invention is not technically confined to a single plant or animal variety (EU Dir. 98/44/EC, rec. 29).

A claim wherein specific plant varieties are not individually claimed is not excluded from patentability under Art. 53(b) even though it may embrace plant varieties (see G 1/98, and G-II, 5.4).

The subject-matter of a claim covering but not identifying plant varieties is not a claim to a variety or varieties (see G 1/98, Reasons 3.8). In the absence of the identification of a specific plant variety in a product claim, the subject-matter of the claimed invention is neither limited nor directed to a variety or varieties

within the meaning of Art. 53(b) (G 1/98, Reasons 3.1 and 3.10);  
or

- (iii) A microbiological or other technical process, or a product obtained by means of such a process other than a plant or animal variety *Rule 27(c)*

"Microbiological process" means any process involving or performed upon or resulting in microbiological material. *Rule 26(6)*

### 5.3 List of exceptions (Rule 28)

In the area of biotechnological inventions, the following list of exceptions to patentability under Art. 53(a) is laid down in Rule 28. The list is illustrative and non-exhaustive and is to be seen as giving concrete form to the concept of "*ordre public*" and "morality" in this technical field.

Under Art. 53(a), in conjunction with Rule 28, European patents are not to be granted in respect of biotechnological inventions which concern: *Rule 28*

- (i) Processes for cloning human beings *Rule 28(a)*

For the purpose of this exception, a process for the cloning of human beings may be defined as any process, including techniques of embryo splitting, designed to create a human being with the same nuclear genetic information as another living or deceased human being (EU Dir. 98/44/EC, rec. 41).

- (ii) Processes for modifying the germ line genetic identity of human beings *Rule 28(b)*

- (iii) Uses of human embryos for industrial or commercial purposes *Rule 28(c)*

A claim directed to a product, which at the filing date of the application could be **exclusively** obtained by a method which necessarily involved the destruction of human embryos from which the said product is derived is excluded from patentability under Rule 28(c), even if said method is not part of the claim (see G 2/06). The point in time at which such destruction takes place is irrelevant.

When examining subject-matter relating to human embryonic stem cells under Art. 53(a) and Rule 28(c), the following has to be taken into account:

- (a) the **entire teaching** of the application, not only the claim category and wording, and
- (b) the **relevant disclosure in the description** in order to establish whether products such as stem cell cultures are

obtained exclusively by the use, involving the destruction, of a human embryo or not. For this purpose, the disclosure of the description has to be considered in view of the state of the art at the date of filing.

The exclusion of the uses of human embryos for industrial or commercial purposes does not affect inventions for therapeutic or diagnostic purposes which are applied to the human embryo and are useful to it (EU Dir. 98/44/EC, rec. 42).

*Rule 28(d)*

- (iv) Processes for modifying the genetic identity of animals which are likely to cause them suffering without any substantial medical benefit to man or animal, and also animals resulting from such processes

The substantial medical benefit referred to above includes any benefit in terms of research, prevention, diagnosis or therapy (EU Dir. 98/44/EC, rec. 45).

*Rule 29(1)*

In addition, the human body, at the various stages of its formation and development, and the simple discovery of one of its elements, including the sequence or partial sequence of a gene, cannot constitute patentable inventions (see, however, G-II, 5.2). Such stages in the formation or development of the human body include germ cells (EU Dir. 98/44/EC, rec. 16).

Also excluded from patentability under Art. 53(a) are processes to produce chimeras from germ cells or totipotent cells of humans and animals (EU Dir. 98/44/EC, rec. 38).

#### **5.4 Plant and animal varieties, essentially biological processes for the production of plants or animals**

*Art. 53(b)*

The list of exceptions to patentability under Art. 53(b) also includes "plant or animal varieties or essentially biological processes for the production of plants or animals".

##### **5.4.1 Plant varieties**

*Rule 26(4)*

*Rule 27(b)*

The term "plant variety" is defined in Rule 26(4). A patent is not to be granted if the claimed subject-matter is directed to a specific plant variety or specific plant varieties. However, if the invention concerns plants or animals and if the technical feasibility of the invention is not confined to a particular plant or animal variety, the invention is patentable (see G-II, 5.2).

A claimed plant grouping is not excluded from patentability under Art. 53(b) if it does not meet the definition of a plant variety set out in Rule 26(4). The method of the plant's production, be it by recombinant gene technology or by a classical plant breeding process, is irrelevant for considering this issue (see T 1854/07).

When a claim to a process for the production of a plant variety is examined, Art. 64(2) is not to be taken into consideration (see G 1/98). Hence, a process claim for the production of a plant variety (or plant varieties) is not a priori excluded from patentability merely because the resulting product constitutes or may constitute a plant variety.

#### **5.4.2 Essentially biological processes for the production of plants or animals**

A process for the production of plants or animals which is based on the sexual crossing of whole genomes and on the subsequent selection of plants or animals is excluded from patentability as being essentially biological, even if other technical steps relating to the preparation of the plant or animal or its further treatment are present in the claim before or after the crossing and selection steps (see G 1/08 and G 2/07). To take some examples, a method of crossing, inter-breeding, or selectively breeding, say, horses involving merely selecting for breeding and bringing together those animals (or their gametes) having certain characteristics would be essentially biological and therefore unpatentable. This method remains essentially biological and unpatentable even if it contains an additional feature of a technical nature, for example the use of genetic molecular markers to select either parent or progeny. On the other hand, a process involving inserting a gene or trait into a plant by genetic engineering does not rely on recombination of whole genomes and the natural mixing of plant genes, and hence is patentable. A process of treating a plant or animal to improve its properties or yield or to promote or suppress its growth e.g. a method of pruning a tree, would not be an essentially biological process for the production of plants or animals since it is not based on the sexual crossing of whole genomes and subsequent selection of plants or animals; the same applies to a method of treating a plant characterised by the application of a growth-stimulating substance or radiation. The treatment of soil by technical means to suppress or promote the growth of plants is also not excluded from patentability (see also G-II, 4.2.1).

*Rule 26(5)*

### **5.5 Microbiological processes**

#### **5.5.1 General remarks**

As expressly stated in Art. 53(b), second half-sentence, the exception referred to in the first half-sentence does not apply to microbiological processes or the products thereof.

*Art. 53(b)*  
*Rule 26(6)*

"Microbiological process" means any process involving or performed upon or resulting in microbiological material. Hence, the term "microbiological process" is to be interpreted as covering not only processes performed upon microbiological material or resulting in such, e.g. by genetic engineering, but also processes which as claimed include both microbiological and non-microbiological steps.

The product of a microbiological process may also be patentable *per se* (product claim). Propagation of the microorganism itself is to be

*Rule 27(c)*

construed as a microbiological process for the purposes of Art. 53(b). Consequently, the microorganism can be protected *per se* as it is a product obtained by a microbiological process (see G-II, 3.1). The term "microorganism" includes bacteria and other generally unicellular organisms with dimensions beneath the limits of vision which can be propagated and manipulated in a laboratory (see T 356/93), including plasmids and viruses and unicellular fungi (including yeasts), algae, protozoa and, moreover, human, animal and plant cells.

On the other hand, product claims for plant or animal varieties cannot be allowed even if the variety is produced by means of a microbiological process (Rule 27(c)). The exception to patentability in Art. 53(b), first half-sentence, applies to plant varieties irrespective of the way in which they are produced. Therefore, plant varieties containing genes introduced into an ancestral plant by recombinant gene technology are excluded from patentability (G 1/98).

#### **5.5.2 Repeatability of results of microbiological processes**

*Rule 33(1)*

In the case of microbiological processes, particular regard should be had to the requirement of repeatability referred to in F-III, 3. As for biological material deposited under the terms of Rule 31, repeatability is assured by the possibility of taking samples (Rule 33(1)), and there is thus no need to indicate another process for the production of the biological material.



## Chapter III – Industrial application

### 1. General remarks

"An invention shall be considered as susceptible of industrial application if it can be made or used in any kind of industry, including agriculture". "Industry" should be understood in its broad sense as including any physical activity of "technical character" (see G-I, 2), i.e. an activity which belongs to the useful or practical arts as distinct from the aesthetic arts; it does not necessarily imply the use of a machine or the manufacture of an article and could cover e.g. a process for dispersing fog or for converting energy from one form to another. Thus, Art. 57 excludes from patentability very few "inventions" which are not already excluded by the list in Art. 52(2) (see F-II, 1). One further class of "invention" which would be excluded, however, would be articles or processes alleged to operate in a manner clearly contrary to well-established physical laws, e.g. a perpetual motion machine. Objection could arise under Art. 57 only insofar as the claim specifies the intended function or purpose of the invention, but if, say, a perpetual motion machine is claimed merely as an article having a particular specified construction then objection should be made under Art. 83 (see F-III, 3).

*Art. 57*

### 2. Method of testing

Methods of testing generally should be regarded as inventions susceptible of industrial application and therefore patentable if the test is applicable to the improvement or control of a product, apparatus or process which is itself susceptible of industrial application. In particular, the utilisation of test animals for test purposes in industry, e.g. for testing industrial products (for example for ascertaining the absence of pyrogenetic or allergic effects) or phenomena (for example for determining water or air pollution) would be patentable.

### 3. Industrial application vs. exclusion under Art. 52(2)

It should be noted that "susceptibility of industrial application" is not a requirement that overrides the restriction of Art. 52(2), e.g. an administrative method of stock control is not patentable, having regard to Art. 52(2)(c), even though it could be applied to the factory store-room for spare parts. On the other hand, although an invention must be "susceptible of industrial application" and the description must indicate, where this is not apparent, the way in which the invention is thus susceptible (see F-II, 4.9), the claims need not necessarily be restricted to the industrial application(s).

### 4. Sequences and partial sequences of genes

In general it is required that the description of a European patent application should, where this is not self-evident, indicate the way in which the invention is capable of exploitation in industry. The invention claimed must have such a sound and concrete technical basis that the skilled person can recognise that its contribution to the art could lead to practical exploitation in industry (see T 898/05). In relation to

*Rule 42(1)(f)*  
*Rule 29(3)*

sequences and partial sequences of genes, this general requirement is given specific form in that the industrial application of a sequence or a partial sequence of a gene must be disclosed in the patent application. A mere nucleic acid sequence without indication of a function is not a patentable invention (EU Dir. 98/44/EC, rec. 23). In cases where a sequence or partial sequence of a gene is used to produce a protein or a part of a protein, it is necessary to specify which protein or part of a protein is produced and what function this protein or part of a protein performs. Alternatively, when a nucleotide sequence is not used to produce a protein or part of a protein, the function to be indicated could e.g. be that the sequence exhibits a certain transcription promoter activity.

## Chapter IV – State of the art

### 1. General remarks and definition

An invention is "considered to be new if it does not form part of the state of the art". The "state of the art" is defined as "everything made available to the public by means of a written or oral description, by use, or in any other way, before the date of filing of the European patent application". The width of this definition should be noted. There are no restrictions whatever as to the geographical location where or the language or manner in which the relevant information was made available to the public; also no age limit is stipulated for the documents or other sources of the information. There are, however, certain specific exclusions (see G-V). However, since the "state of the art" available to the examiner will mainly consist of the documents listed in the search report, this chapter G-IV deals with the question of public availability only in relation to written description (either alone or in combination with an earlier oral description or use).

*Art. 54(1) and (2)*

The principles to be applied in determining whether other kinds of prior art (which could be introduced into the proceedings e.g. by a third party under Art. 115) have been made available to the public are set out in G-IV, 7.1 to 7.4.

For the examination of the novelty of claimed subject-matter, see G-VI.

*Art. 52(1)*

A written description, i.e. a document, should be regarded as made available to the public if, at the relevant date, it was possible for members of the public to gain knowledge of the content of the document and there was no bar of confidentiality restricting the use or dissemination of such knowledge. For instance, German utility models ("Gebrauchsmuster") are already publicly available as of their date of entry in the Register of utility models ("Eintragungstag"), which precedes the date of announcement in the Patent Bulletin ("Bekanntmachung im Patentblatt"). The search report also cites documents in which doubts with regard to the fact of public availability (for "in-house state of the art", see F-II, 4.3) and doubts concerning the precise date of publication (see B-VI, 5.6 and G-IV, 7.5) of a document have not, or not fully, been removed (see B-VI, 5.6 and G-IV, 7.5).

If the applicant contests the public availability or assumed date of publication of the cited document, the examiner should consider whether to investigate the matter further. If the applicant shows sound reasons for doubting whether the document forms part of the "state of the art" in relation to his application and any further investigation does not produce evidence sufficient to remove that doubt, the examiner should not pursue the matter further. The only other problem likely to arise for the examiner is where:

- (i) a document reproduces an oral description (e.g. a public lecture) or gives an account of a prior use (e.g. display at a public exhibition); and
- (ii) only the oral description or lecture was publicly available before the "date of filing" of the European application, the document itself being published on or after this date.

In such cases, the examiner should start with the assumption that the document gives a true account of the earlier lecture, display or other event and should therefore regard the earlier event as forming part of the "state of the art". If, however, the applicant gives sound reasons for contesting the truth of the account given in the document then again the examiner should not pursue the matter further.

## **2. Enabling disclosures**

Subject-matter can only be regarded as having been made available to the public, and therefore as comprised in the state of the art pursuant to Art. 54(1), if the information given to the skilled person is sufficient to enable him, at the relevant date (see G-VI, 3), to practise the technical teaching which is the subject of the disclosure, taking into account also the general knowledge at that time in the field to be expected of him (see T 26/85, T 206/83 and T 491/99).

Where a prior art document discloses subject-matter which is relevant to the novelty and/or inventive step of the claimed invention, the disclosure of that document must be such that the skilled person can reproduce that subject-matter using common general knowledge (see G-VII, 3.1). Subject-matter does not necessarily belong to the common general knowledge simply because it has been disclosed in the state of the art: in particular, if the information can only be obtained after a comprehensive search, it cannot be considered to belong to the common general knowledge and cannot be used to complete the disclosure (see T 206/83).

For example, a document discloses a chemical compound (identified by name or by structural formula), indicating that the compound may be produced by a process defined in the document itself. The document, however, does not indicate how to obtain the starting materials and/or reagents used in the process. If the skilled person moreover cannot obtain these starting materials or reagents on the basis of common general knowledge (e.g. from text books), the

document is insufficiently disclosed with respect to that compound. Hence, it is not considered to belong to the state of the art according to Art. 54(2) (at least in as far as it relates to that compound) and consequently it does not prejudice the patentability of the claimed invention.

If, on the other hand, the skilled person knows how to obtain the starting materials and reagents (e.g. they are commercially available, or are well-known and appear in reference text books), the document is sufficiently disclosed with respect to the compound and therefore belongs to the state of the art according to Art. 54(2). The examiner can then validly rely upon this document to raise objections against the claimed invention.

### 3. Date of filing or priority date as effective date

It should be noted that "date of filing" in Art. 54(2) and (3) is to be interpreted as meaning the date of priority in appropriate cases (see F-VI, 1.2). It should be remembered that different claims, or different alternatives claimed in one claim, may have different effective dates, i.e. the date of filing or (one of) the claimed priority date(s). The question of novelty must be considered against each claim (or part of a claim where a claim specifies a number of alternatives) and the state of the art in relation to one claim or one part of a claim may include matter, e.g. an intermediate document (see B-X, 9.2.4), which cannot be cited against another claim or another alternative in the same claim because it has an earlier effective date.

*Art. 89*

The priority right of the application being examined or the patent being opposed may also be lost as a result of failure to provide a translation of the priority when requested in accordance with Rule 53(3) (see A-III, 6.8 and sub-sections).

Of course, if all the matter in the state of the art was made available to the public before the date of the earliest priority document, the examiner need not (and should not) concern himself with the allocation of effective dates.

If the applicant files missing parts of the description, or drawings (see A-II, 5.1), late under Rule 56, the accorded date of the application is the date of filing of these missing elements under Rule 56(2) (see A-II, 5.3), unless they are completely contained in the priority document and the requirements given in Rule 56(3) are satisfied (see A-II, 5.4), in which case the original filing date is maintained. The date of the application as a whole is thus either the date of filing of the missing elements or the original filing date.

*Rule 56*

== Claims filed in response to a communication under Rule 58 do not result in a change in the filing date of the application (see A-III, 15), as they are considered as amendments to the application as filed (see H-IV, 2.3.3).

*Rule 58*

#### 4. Documents in a non-official language

If the applicant

- (i) disputes the relevance of a document in a non-official language cited in the search report (for procedure at the search stage, see B-X, 9.1.2 and 9.1.3), and
- (ii) gives specific reasons,

the examiner should consider whether, in the light of these reasons and of the other prior art available to him, he is justified in pursuing the matter. If so, he should obtain a translation of the document (or merely the relevant part of it if that can be easily identified). If he remains of the view that the document is relevant, he should send a copy of the translation to the applicant with the next official communication.

##### 4.1 Machine translations

In order to overcome the language barrier constituted by a document in an unfamiliar non-official language, it might be appropriate for the examiner to rely on a machine translation of said document (see T 991/01), which should be sent to the applicant (see B-X, 9.1.3). If only part of the translated document is relevant, the particular passage relied upon should be identified (see B-XI, 3.2). A translation has to serve the purpose of rendering the meaning of the text in a familiar language (see B-X, 9.1.3). Therefore mere grammatical or syntactical errors which have no impact on the possibility of understanding the content do not hinder its qualification as a translation (see T 287/98).

A general statement that machine translations as such cannot be trusted is not sufficient to invalidate the probatory value of the translation. If a party objects to the use of a specific machine translation, that party bears the burden of adducing evidence (in the form of, for instance, an improved translation of the whole or salient parts of the document) showing the extent to which the quality of the machine translation is defective and should therefore not be relied upon.

When the party provides substantiated reasoning for questioning the objections raised based on the translated text, the examiner will have to take these reasons into account, similarly to when the publication date is questioned (see G-IV, 7.5.3).

#### 5. Conflict with other European applications

##### 5.1 State of the art pursuant to Art. 54(3)

The state of the art also comprises the content of other European applications filed or validly claiming a priority date earlier than – but published under Art. 93 on or after – the date of filing or valid date of priority of the application being examined. Such earlier applications are part of the state of the art only when considering novelty and not when

*Art. 54(3)*

*Art. 56*

*Art. 89*

*Art. 85*

considering inventive step. The "date of filing" referred to in Art. 54(2) and (3) is thus to be interpreted as meaning the date of priority in appropriate cases (see F-VI, 1.2). By the "content" of a European application is meant the whole disclosure, i.e. the description, drawings and claims, including:

- (i) any matter explicitly disclaimed (with the exception of disclaimers for unworkable embodiments);
- (ii) any matter for which an allowable reference (see F-III, 8, penultimate paragraph) to other documents is made; and
- (iii) prior art insofar as explicitly described.

However, the "content" does not include any priority document (the purpose of such document being merely to determine to what extent the priority date is valid for the disclosure of the European application (see F-VI, 1.2)) nor, in view of Art. 85, the abstract (see F-II, 2).

It is important to note that it is the content of the earlier application as filed which is to be considered when applying Art. 54(3). Where an application is filed in a non-official language as permitted by Art. 14(2) (see A-VII, 1.1), it may happen that matter is erroneously omitted from the translation in the language of the proceedings and not published under Art. 93 in that language. Even in this case, it is the content of the original text which is relevant for the purposes of Art. 54(3).

### **5.1.1 Requirements**

Whether a published European application can be a conflicting application under Art. 54(3) is determined firstly by its filing date and the date of its publication; the former must be before the filing or valid priority date of the application under examination, the latter must be on or after that date. If the published European application claims priority, the priority date replaces the filing date (Art. 89) for that subject-matter in the application which corresponds to the priority application. If a priority claim was abandoned or otherwise lost with effect from a date prior to publication, the filing date and not the priority date is relevant, irrespective of whether or not the priority claim might have conferred a valid priority right.

Further it is required that the conflicting application was still pending at its publication date (see J 5/81). If the application was withdrawn or otherwise lost before the date of publication, but published because the preparations for publication had been completed, the publication has no effect under Art. 54(3), but only under Art. 54(2). Art. 54(3) must be interpreted as referring to the publication of a "valid" application, i.e. a European patent application in existence at its publication date.

Changes taking effect after the date of publication (e.g. withdrawal of a designation or withdrawal of the priority claim or loss of the priority right

for other reasons) do not affect the application of Art. 54(3) (see H-III, 4.2 for transitional provisions concerning Art. 54(4) EPC 1973 and A-III, 11.1 and 11.3 for transitional arrangements concerning non-payment of designation fees for applications filed before 1 April 2009).

### **5.1.2 Accorded date of filing still subject to review**

The prior art considered by the examiner might comprise documents (European or international patent applications) for which the accorded date of filing may still be under review before the EPO. This might be the case, for instance, when:

- (i) a European patent application contains parts of the description and/or drawings filed under Rule 56, or
- (ii) an international patent application contains elements or parts of the description, drawings or claims filed under Rule 20.5 or 20.6 PCT.

The examiner should check whether a final decision on the accorded date of filing has already been taken before considering the documents as being state of the art under Art. 54(3). If the date of filing has not yet been established, the examiner should temporarily deal with the documents (if relevant for assessing the patentability of the claimed subject-matter) as if their accorded date of filing were correct, revisiting the issue at a later point in time.

## **5.2 Euro-PCT applications**

The above principles also apply to PCT applications designating EP, but with an important difference. Art. 153, in conjunction with Rule 165, makes it clear that a PCT application is not included in the state of the art for the purposes of Art. 54(3) unless the PCT applicant has paid the required filing fee under Rule 159(1)(c) and has supplied the PCT application to the EPO in English, French or German (this means that a translation is required where the PCT application was published in Japanese, Chinese, Spanish, Russian, Korean, Portuguese or Arabic).

## **5.3 Commonly designated States**

See H-III, 4.2 for the transitional applicability of Art. 54(4) EPC 1973 to applications which are pending on 13 December 2007 and patents which have already been granted on that date.

## **5.4 Double patenting**

The EPC does not deal explicitly with the case of co-pending European applications of the same effective date filed by the same applicant. However, it is an accepted principle in most patent systems that two patents cannot be granted to the same applicant for one invention. The Enlarged Board of Appeal has accepted obiter dictum that the principle of the prohibition on double patenting is based on the notion that an applicant has no legitimate interest in proceedings leading to the grant of a second patent for the same subject-matter if he already possesses

*Art. 153*  
*Rule 165*



one granted patent for that subject-matter (see G 1/05, and G 1/06). It is permissible to allow an applicant to proceed with two applications having the same description which do not claim the same subject-matter (see also T 2461/10). The applicant may, for example, be interested in obtaining a first quicker protection for a preferred embodiment and pursue the general teaching in a divisional application (see G 2/10). However, in the rare case in which there are two or more European applications from the same applicant definitively designating the same State or States (by confirming the designation through payment of the relevant designation fee) and the claims of those applications have the same filing or priority date and relate to the same invention, the applicant should be told that he must either amend one or more of the applications in such a manner that the subject-matter of the claims of the applications is not identical, or choose which one of those applications he wishes to proceed to grant. If he does not do so, once one of the applications is granted, the other(s) will be refused under Art. 97(2) in conjunction with Art. 125. If the claims of those applications are merely partially overlapping, no objection should be raised (see T 877/06). Should two applications of the same effective date be received from two different applicants, each must be allowed to proceed as though the other did not exist.

## **6. Conflict with national rights of earlier date**

Where a national right of an earlier date exists in a Contracting State designated in the application, there are several possibilities of amendment open to the applicant. First, he may simply withdraw that designation from his application for the Contracting State of the national right of earlier date. Second, for such State, he may file claims which are different from the claims for the other designated States. Third, the applicant can limit his existing set of claims in such a manner that the national right of earlier date is no longer relevant.

*Rule 138*

Amendment of the application to take account of prior national rights should be neither required nor suggested (see also H-III, 4.5). However, if the claims have been amended, then amendment of the description and drawings should be required if necessary to avoid confusion.

## **7. State of the art made available to the public "by use or in any other way"**

### **7.1 Types of use and instances of state of the art made available in any other way**

Use may be constituted by producing, offering, marketing or otherwise exploiting a product, or by offering or marketing a process or its application or by applying the process. Marketing may be effected, for example, by sale or exchange.

The state of the art may also be made available to the public in other ways, as for example by demonstrating an object or process in specialist training courses or on television.

Availability to the public in any other way also includes all possibilities which technological progress may subsequently offer of making available the aspect of the state of the art concerned.

Instances of public prior use or availability in any other way will typically be raised in opposition proceedings. While they may arise in examination, they are so rare that the following guidelines are addressed to opposition divisions.

## **7.2 Matters to be determined by the Opposition Division as regards use**

When dealing with an allegation that an object or process has been used in such a way that it is comprised in the state of the art, the Opposition Division will have to determine the following details:

- (i) the date on which the alleged use occurred, i.e. whether there was any instance of use before the relevant date (prior use);
- (ii) what has been used, in order to determine the degree of similarity between the object used and the subject-matter of the European patent; and
- (iii) all the circumstances relating to the use, in order to determine whether and to what extent it was made available to the public, as for example the place of use and the form of use. These factors are important in that, for example, the details of a demonstration of a manufacturing process in a factory or of the delivery and sale of a product may well provide information as regards the possibility of the subject-matter having become available to the public.

On the basis of the submissions and the evidence already submitted, e.g. documents confirming sale, or affidavits related to the prior use, the Opposition Division will first establish the relevance of the alleged prior use. If on the basis of this assessment it is of the opinion that the prior use is sufficiently substantiated and relevant, it may decide on the opposition using the submissions and the evidence, if the patentee does not contest the prior use. If the patentee does contest it or certain circumstances of it, the Division will need to take further evidence, if offered (e.g. hearing witnesses or performing an inspection) for those facts which are relevant to the case and which cannot yet be considered proven on the basis of the evidence already submitted. Evidence is always taken under participation of the parties, normally in oral proceedings. For details concerning means of evidence see E-III, 1.2.

### **7.2.1 General principles**

Subject-matter should be regarded as made available to the public by use or in any other way if, at the relevant date, it was possible for members of the public to gain knowledge of the subject-matter and there was no bar of confidentiality restricting the use or dissemination

of such knowledge (see also G-IV, 1 with reference to written descriptions). This may, for example, arise if an object is unconditionally sold to a member of the public, since the buyer thereby acquires unlimited possession of any knowledge which may be obtained from the object. Even where in such cases the specific features of the object may not be ascertained from an external examination, but only by further analysis, those features are nevertheless to be considered as having been made available to the public. This is irrespective of whether or not particular reasons can be identified for analysing the composition or internal structure of the object. These specific features only relate to the intrinsic features. Extrinsic characteristics, which are only revealed when the product is exposed to interaction with specifically chosen outside conditions, e.g. reactants or the like, in order to provide a particular effect or result or to discover potential results or capabilities, therefore point beyond the product *per se* as they are dependent on deliberate choices being made. Typical examples are the first or further application as a pharmaceutical product of a known substance or composition (see Art. 54(4) and (5)) and the use of a known compound for a particular purpose, based on a new technical effect (see G 2/88). Thus, such characteristics cannot be considered as already having been made available to the public (see G 1/92).

If, on the other hand, an object could be seen in a given place (a factory, for example) to which members of the public not bound to secrecy, including persons with sufficient technical knowledge to ascertain the specific features of the object, had access, all knowledge which an expert was able to gain from a purely external examination is to be regarded as having been made available to the public. In such cases, however, all concealed features which could be ascertained only by dismantling or destroying the object will not be deemed to have been made available to the public.

### **7.2.2 Agreement on secrecy**

The basic principle to be adopted is that subject-matter has not been made available to the public by use or in any other way if there is an express or tacit agreement on secrecy which has not been broken, or if the circumstances of the case are such that such secrecy derives from a relationship of good faith or trust. Good faith and trust are factors which may occur in contractual or commercial relationships. Reference should be made to the particular case of a non-prejudicial disclosure arising from an evident abuse in relation to the applicant, in accordance with Art. 55(1)(a) (see below, G-IV, 7.3.2; G-V).

### **7.2.3 Use on non-public property**

As a general rule, use on non-public property, for example in factories and barracks, is not considered as use made available to the public, because company employees and soldiers are usually bound to secrecy, save in cases where the objects or processes used are exhibited, explained or shown to the public in such places, or where specialists not bound to secrecy are able to recognise their essential

features from the outside. Clearly the above-mentioned "non-public property" does not refer to the premises of a third party to whom the object in question was unconditionally sold or the place where the public could see the object in question or ascertain features of it (see the examples in G-IV, 7.2.1 above).

#### **7.2.4 Example of the accessibility of objects used**

A press for producing light building (hard fibre) boards was installed in a factory shed. Although the door bore the notice "Unauthorised persons not admitted", customers (in particular dealers in building materials and clients who were interested in purchasing light building boards) were given the opportunity of seeing the press although no form of demonstration or explanation was given. An obligation to secrecy was not imposed as, according to witnesses, the company did not consider such visitors as a possible source of competition. These visitors were not genuine specialists, i.e. they did not manufacture such boards or presses, but were not entirely laymen either. In view of the simple construction of the press, the essential features of the invention concerned were bound to be evident to anyone observing it. There was therefore a possibility that these customers, and in particular the dealers in building materials, would recognise these essential features of the press and, as they were not bound to secrecy, they would be free to communicate this information to others.

#### **7.2.5 Example of the inaccessibility of a process**

The subject of the patent concerns a process for the manufacture of a product. As proof that this process had been made available to the public by use, a similar already known product was asserted to have been produced by the process claimed. However, it could not be clearly ascertained, even after an exhaustive examination, by which process it had been produced.

### **7.3 State of the art made available by means of oral description**

#### **7.3.1 Cases of oral description**

*Art. 54(2)*

The state of the art is made available to the public by oral description when facts are unconditionally brought to the knowledge of members of the public in the course of a conversation or a lecture or by means of radio, television or sound reproduction equipment (tapes and records).

#### **7.3.2 Non-prejudicial oral description**

*Art. 55(1)(a)*

The state of the art will not be affected by oral descriptions made by and to persons who were bound to, and preserved, secrecy, nor by an oral disclosure which was made no earlier than six months before the filing of the European patent application and which derives directly or indirectly from an evident abuse in relation to the applicant or his legal predecessor. In determining whether evident abuse has occurred, note G-V, 3.

### **7.3.3 Matters to be determined by the Opposition Division in cases of oral description**

Once again, in such cases the following details will have to be determined:

- (i) when the oral description took place;
- (ii) what was described orally; and
- (iii) whether the oral description was made available to the public; this will also depend on the type of oral description (conversation, lecture) and on the place at which the description was given (public meeting, factory hall; see also G-IV, 7.2(iii)).

### **7.4 State of the art made available to the public in writing or by any other means**

For this state of the art, details equivalent to those defined in G-IV, 7.3.3 have to be determined if they are not clear from the written or other disclosure itself or if they are contested by a party.

If information is made available by means of a written description and use or by means of a written and oral description, but only the use or the oral description is made available before the relevant date, then in accordance with G-IV, 1, the subsequently published written description may be deemed to give a true account of that oral description or use, unless the proprietor of the patent can give good reason why this should not be the case. In this case, the opponent must adduce proof to the contrary in respect of the reasons given by the proprietor of the patent. Caution should be exercised when considering the type of evidence presented to substantiate the content of an oral description. For example, a report of a lecture written by the lecturer himself may not be an accurate account of what was in fact conveyed to the public. Similarly, a script from which the lecturer purportedly read may not actually have been completely and comprehensibly read (see T 1212/97).

### **7.5 Internet disclosures**

As a matter of principle, disclosures on the internet form part of the state of the art according to Art. 54(2). Information disclosed on the internet or in online databases is considered to be publicly available as of the date the information was publicly posted. Internet websites often contain highly relevant technical information. Certain information may even be available only on the internet from such websites. This includes, for example, online manuals and tutorials for software products (such as video games) or other products with a short life cycle. Hence for the sake of a valid patent it is often crucial to cite publications only obtainable from such internet websites.

#### **7.5.1 Establishing the publication date**

Establishing a publication date has two aspects. It must be assessed separately whether a given date is indicated correctly and whether the

content in question was indeed made available to the public as of that date.

The nature of the internet can make it difficult to establish the actual date on which information was made available to the public: for instance, not all web pages mention when they were published. Also, websites are easily updated, yet most do not provide any archive of previously displayed material, nor do they display records which enable members of the public - including examiners - to establish precisely what was published and when.

Neither restricting access to a limited circle of people (e.g. by password protection) nor requiring payment for access (analogous to purchasing a book or subscribing to a journal) prevent a web page from forming part of the state of the art. It is sufficient if the web page is in principle available without any bar of confidentiality.

Finally, it is theoretically possible to manipulate the date and content of an internet disclosure (as it is with traditional documents). However, in view of the sheer size and redundancy of the content available on the internet, it is considered very unlikely that an internet disclosure discovered by an examiner has been manipulated. Consequently, unless there are specific indications to the contrary, the date can be accepted as being correct.

#### **7.5.2 Standard of proof**

When an internet document is cited against an application or patent, the same facts are to be established as for any other piece of evidence, including standard paper publications (see G-IV, 1). This evaluation is made according to the principle of "free evaluation of evidence" (see T 482/89, and T 750/94). That means that each piece of evidence is given an appropriate weight according to its probative value, which is evaluated in view of the particular circumstances of each case. The standard for assessing these circumstances is the balance of probabilities. According to this standard, it is not sufficient that the alleged fact (e.g. the publication date) is merely probable; the examining division must be convinced that it is correct. It does mean, however, that proof beyond reasonable doubt ("up to the hilt") of the alleged fact is not required.

The publication dates of internet disclosures submitted by a party to opposition proceedings are assessed according to the same principles as are applied in examination proceedings, i.e. they should be assessed in view of the specific circumstances of the case. In particular, the timing of the submission as well as the interests of the party submitting the disclosure should also be taken into account.

In many cases, internet disclosures contain an explicit publication date which is generally considered reliable. Such dates are accepted at face value, and the burden of proof will be on the applicant to show otherwise. Circumstantial evidence may be required to establish or

confirm the publication date (see G-IV, 7.5.4). If the examiner comes to the conclusion that - on the balance of probabilities - it has been established that a particular document was available to the public at a particular date, this date is used as publication date for the purpose of examination.

### **7.5.3 Burden of proof**

It is a general principle that, when raising objections, the burden of proof lies initially with the examiner. This means that objections must be reasoned and substantiated, and must show that, on the balance of probabilities, the objection is well-founded. If this is done, it is then up to the applicant to prove otherwise - the burden of proof shifts to the applicant.

If an applicant provides reasons for questioning the alleged publication date of an internet disclosure, the examiner will have to take these reasons into account. If the examiner is no longer convinced that the disclosure forms part of the state of the art, he will either have to present further evidence to maintain the disputed publication date or will not use this disclosure further as prior art against the application.

The later the examiner sets out to obtain such evidence, the more difficult it may become. The examiner should use his judgment to decide whether it is worth spending a short amount of time at the search stage to find further evidence in support of the publication date.

If an applicant refutes the publication date of an internet disclosure with no reasoning or merely with generic statements about the reliability of internet disclosures, this argument will be given minimal weight and is therefore unlikely to sway the examiner's opinion.

While the dates and content of internet disclosures can be taken at face value, there are of course differing degrees of reliability. The more reliable a disclosure, the harder it will be for the applicant to prove that it is incorrect. The following sections look at the reliability of various popular types of internet disclosure.

#### **7.5.3.1 Technical journals**

Of particular importance for examiners are online technical journals from scientific publishers (e.g. IEEE, Springer, Derwent). The reliability of these journals is the same as that of traditional paper journals, i.e. very high.

It should be noted that the internet publication of a particular issue of a journal may be earlier than the date of publication of the corresponding paper version. Furthermore, some journals pre-publish on the internet manuscripts which have been submitted to them, but which have not yet been published, and in some cases before they have even been approved for paper publication (for example, the "Geophysics" journal). If the journal then does not approve the manuscript for publication, this pre-publication of the manuscript may be the only

disclosure of its content. Examiners should also remember that the pre-published manuscript may differ from the final, published version.

Where the given publication date of an online journal publication is too vague (e.g. only the month and year is known), and the most pessimistic possibility (the last day of the month) is too late, the examiner may request the exact publication date. Such a request may be made directly through a contact form that the publisher may offer on the internet, or via the EPO library.

### **7.5.3.2 Other "print equivalent" publications**

Many sources other than scientific publishers are generally deemed to provide reliable publication dates. These include for example publishers of newspapers or periodicals, or television or radio stations. Academic institutions (such as academic societies or universities), international organisations (such as the European Space Agency ESA), public organisations (such as ministries or public research agencies) or standardisation bodies also typically fall into this category.

Some universities host so-called eprint archives to which authors submit reports on research results in electronic form before they are submitted or accepted for publication by a conference or journal. In fact, some of these reports are never published anywhere else. The most prominent such archive is known as arXiv.org ([www.arxiv.org](http://www.arxiv.org), hosted by the Cornell University Library), but several others exist, e.g. the Cryptology eprint archive ([eprint.iacr.org](http://eprint.iacr.org), hosted by the International Association for Cryptology Research). Some such archives crawl the internet to automatically retrieve publications which are publicly available from researchers' web pages, such as Citeseer or ChemXseer ([citeseer.ist.psu.edu](http://citeseer.ist.psu.edu) and [chemxseer.ist.psu.edu](http://chemxseer.ist.psu.edu), both hosted by Pennsylvania State University).

Companies, organisations or individuals use the internet to publish documents that had previously been published on paper. These include manuals for software products such as video games, handbooks for products such as mobile phones, product catalogues or price lists and white papers on products or product families. Evidently, most of these documents address the public - e.g. actual or potential customers - and are thus meant for publication. Hence the date given can be taken as a date of publication.

### **7.5.3.3 Non-traditional publications**

The internet is also used to exchange and publish information in ways which did not exist before, via, for example, Usenet discussion groups, blogs, e-mail archives of mailing lists or wiki pages. Documents obtained from such sources also constitute prior art, although it may be more involved to establish their publication date, and their reliability may vary.

The content of a transmitted e-mail cannot be considered to be public merely for the reason that it could have been intercepted (T 2/09).



Computer-generated timestamps (usually seen, for example, on blogs, Usenet or the version history available from wiki pages) can be considered as reliable publication dates. While such dates could have been generated by an imprecise computer clock, this should be weighed against the fact that in general many internet services rely on accurate timing and will often stop functioning if time and date are incorrect. In the absence of indications to the contrary, the frequently used "last modified" date can be treated as the publication date.

#### **7.5.4 Disclosures which have no date or an unreliable date**

Where an internet disclosure is relevant for examination but does not give any explicit indication of the publication date in the text of the disclosure, or if an applicant has shown that a given date is unreliable, the examiner may try to obtain further evidence to establish or confirm the publication date. Specifically, he may consider using the following information:

- (a) Information relating to a web page available from an internet archiving service. The most prominent such service is the Internet Archive accessible through the so-called "Wayback Machine" ([www.archive.org](http://www.archive.org)). The fact that the Internet Archive is incomplete does not detract from the credibility of the data it does archive. It is also noted that legal disclaimers relating to the accuracy of any supplied information are routinely used on websites (even respected sources of information such as Espacenet or IEEE), and these disclaimers should not be taken to reflect negatively on the websites' actual accuracy.
- (b) Timestamp information relating to the history of modifications applied to a file or web page (for example, as available for wiki pages such as Wikipedia and in version control systems as used for distributed software development).
- (c) Computer-generated timestamp information as available from file directories or other repositories, or as automatically appended to content (e.g. forum messages and blogs).
- (d) Indexing dates given to the web page by search engines (e.g. from the Google cache). These will be later than the actual publication date of the disclosure, since the search engines take some time to index a new website.
- (e) Information relating to the publication date embedded in the internet disclosure itself. Date information is sometimes hidden in the programming used to create the website but is not visible in the web page as it appears in the browser. Examiners may, for example, consider the use of computer forensic tools to retrieve such dates. In order to allow a fair evaluation of the accuracy of the date by both the applicant and the examiner, these dates should be used only if the examiner knows how they were obtained and can communicate this to the applicant.

- (f) Information about replication of the disclosure at several sites (mirror sites) or in several versions.

It may also be possible to make enquiries with the owner or the author of the website when trying to establish the publication date to a sufficient degree of certainty. The probative value of statements so obtained will have to be assessed separately.

If no date can be obtained (other than the date of retrieval by the examiner, which will be too late for the application in question), the disclosure cannot be used as prior art during examination. If the examiner considers that a publication, although undated, is highly relevant to the invention and can therefore be considered to be of interest to the applicant or third parties, he may choose to cite the publication in the search report as an "L" document. The search report and the written opinion should explain why this document was cited. Citing the disclosure will also make it citable against future applications, using the date of retrieval as the date of publication.

#### **7.5.5 Problematic cases**

Web pages are sometimes divided into frames the content of which is drawn from different sources. Each of these frames may have its own publication date which may have to be checked. In an archiving system, for instance, it may happen that one frame contains the archived information with an old publishing date whereas other frames contain commercials generated at the time of retrieval. The examiner should ensure that he uses the right publication date, i.e. that the cited publication date refers to the intended content.

When a document retrieved from the Internet Archive contains links, there is no guarantee that the links point to documents archived on the same date. It may even happen that the link does not point to an archived page at all but to the current version of the web page. This may in particular be the case for linked images, which are often not archived. It may also happen that archived links do not work at all.

Some internet addresses (URLs) are not persistent, i.e. they are designed to work only during a single session. Long URLs with seemingly random numbers and letters are indicative of these. The presence of such a URL does not prevent the disclosure being used as prior art, but it does mean that the URL will not work for other people (e.g. the applicant when he receives the search report). For non-persistent URLs, or if, for other reasons, it is considered prudent, the examiner should indicate how he arrived at that specific URL from the main home page of the respective website (i.e. which links were followed, or which search terms were used).

#### **7.5.6 Technical details and general remarks**

When printing a web page, care should be taken that the complete URL is clearly legible. The same applies to the relevant publication date on a web page.

It should be borne in mind that publication dates may be given in different formats, especially in either the European format dd/mm/yyyy, the US format mm/dd/yyyy or the ISO format yyyy/mm/dd. Unless the format is explicitly indicated, it will be impossible to distinguish between the European format and the US format for days 1-12 of each month.

If a publication date is close to the relevant priority date, the time zone of publication may be crucial to interpret a publication date.

The examiner should always indicate the date on which the web page was retrieved. When citing internet disclosures, he should explain the prior art status of the document, e.g. how and where he obtained the publication date (for example, that the eight digits in the URL represent the date of archiving in the format yyyymmdd), and any other relevant information (for example, where two or more related documents are cited, how they are related, indicating for instance that following link 'xyz' on the first document leads to the second document).

#### **7.6 Standards and standard preparatory documents**

Standards define sets of characteristics or qualities for products, processes, services or materials (e.g. the properties of an interface) and are usually developed by Standards Development Organisations (SDOs) by consensus amongst the relevant economic stakeholders.

Final standards themselves in principle form part of the state of the art under Art. 54(2), although there are important exceptions. One of these relates to private standards consortia (e.g. in the field of CD-ROM, DVD and Blu-ray discs), which do not publish the final standards but make them available to the interested circles subject to acceptance of a non-disclosure agreement (categorically forbidding the recipients of the documents to disclose their content).

Before an SDO reaches agreement on the establishment or further development of a standard, various types of preparatory documents are submitted and discussed. These preparatory documents should be treated like any other written or oral disclosures, i.e. in order to qualify as prior art they must have been made available to the public prior to the filing or priority date without any bar of confidentiality. Thus if a standard preparatory document is cited against an application during search or examination, the same facts are to be established as for any other piece of evidence (see G-IV, 1 and T 738/04).

The existence of an explicit confidentiality obligation must be determined case by case on the basis of the documents allegedly setting forth this obligation (see T 273/02 and T 738/04). These may be general guidelines, directives or principles of the SDO concerned, licensing terms or a Memorandum of Understanding resulting from interaction between the SDOs and their members. In case of a general confidentiality clause, i.e. one that is not indicated on or in the relevant preparatory document itself, it must be established that the general confidentiality obligation actually extended to the document in question

until the relevant point in time. This does not however require the document itself to be explicitly marked as confidential (see T 273/02).

If the preparatory documents are available in the EPO's in-house databases or at freely accessible sources (for example, on the internet), the examiner is allowed to cite them in the search report and to refer to them during the procedure. The public availability of the documents, if at all necessary, may be further investigated during examination and opposition in accordance with the principles set out above.

While documents in the EPO's in-house databases are regarded as being available to the public, no general indication can be given for documents obtained from other sources.

Norms and standards are comparable with trademarks in that their content can vary with time. Therefore, they have to be identified properly by their version number and publication date (see also F-III, 7, F-IV, 4.8, and H-IV, 2.3.9).

#### **8. Cross-references between prior art documents**

If a document (the "primary" document) refers explicitly to another document (the "secondary" document) as providing more detailed information on certain features, the teaching of the latter is to be regarded as incorporated into the primary document if the document was available to the public on the publication date of the primary document (see T 153/85) (for the state of the art pursuant to Art. 54(3), see G-IV, 5.1 and F-III, 8, penultimate paragraph). The relevant date for novelty purposes, however, is always the date of the primary document (see G-IV, 3).

#### **9. Errors in prior art documents**

Errors may exist in prior art documents. If, using common general knowledge (see G-VII, 3.1), the skilled person can

- (i) see at once that the disclosure of a relevant prior art document contains errors, and
- (ii) identify what the only possible correction should be,

then the errors in the disclosure do not affect its relevance as prior art. The document can thus be considered to contain the correction when assessing its relevance to patentability (see T 591/90).

For possible errors concerning compound records in online databases, see B-VI, 6.5.

## Chapter V – Non-prejudicial disclosures

### 1. General

There are two specific instances (and these are the only two) in which a prior disclosure of the invention is not taken into consideration as part of the state of the art, viz. where the disclosure was due to, or in consequence of: *Art. 55(1)*

- (i) an evident abuse in relation to the applicant or his legal predecessor – e.g. the invention was derived from the applicant and disclosed against his wish; or *Art. 55(1)(a)*
- (ii) the display of the invention by the applicant or his legal predecessor at an officially recognised international exhibition as defined in Art. 55(1)(b). *Art. 55(1)(b)*

### 2. Time limit

An essential condition, in both instances G-V, 1(i) and (ii), is that the disclosure in point must have taken place not earlier than six months preceding the filing of the application. For calculating the six-month period the relevant date is that of the actual filing date of the European patent application, not the priority date (G 3/98, and G 2/99).

### 3. Evident abuse

Regarding instance G V, 1(i), the disclosure might be made in a published document or in any other way. As a particular instance, the disclosure might be made in a European application of earlier priority date. Thus, for example, a person B who has been told of A's invention in confidence, might himself apply for a patent for this invention. If so, the disclosure resulting from the publication of B's application will not prejudice A's rights provided that A has already made an application, or applies within six months of such publication. In any event, having regard to Art. 61, B may not be entitled to proceed with his application (see G-VI, 2).

For "evident abuse" to be established, there must be, on the part of the person disclosing the invention, either actual intent to cause harm or actual or constructive knowledge that harm would or could ensue from this disclosure (see T 585/92).

### 4. International exhibition

In instance G-V, 1(ii), the application must be filed within six months of the disclosure of the invention at the exhibition if the display is not to prejudice the application. Furthermore, the applicant must state, at the time of filing the application, that the invention has been so displayed, and must also file a supporting certificate within four months, giving the particulars required by Rule 25 (see A-IV, 3). The exhibitions recognised are published in the Official Journal. *Art. 55(2)*  
*Rule 25*



## Chapter VI – Novelty

### 1. State of the art pursuant to Art. 54(2)

An invention is considered to be new if it does not form part of the state of the art. For a definition of "state of the art", see G-IV, 1. It should be noted that in considering novelty (as distinct from inventive step, see G-VII, 8), it is not permissible to combine separate items of prior art together. It is also not permissible to combine separate items belonging to different embodiments described in one and the same document, unless such combination has specifically been suggested (see T 305/87).

The concept of "seriously contemplating" (see G-VI, 8(iii)) may be used to assess novelty in the case of overlapping ranges of claimed subject-matter and the prior art (see T 666/89). This concept is fundamentally different from the concept used for assessing inventive step, namely whether the skilled person "would have tried, with reasonable expectation of success", to bridge the technical gap between a particular piece of prior art and a claim whose inventiveness is in question (see G-VII, 5.3), because in order to establish anticipation, there cannot be such a gap.

Furthermore, any matter explicitly disclaimed (with the exception of disclaimers which exclude unworkable embodiments) and prior art acknowledged in a document, insofar as explicitly described therein, are to be regarded as incorporated in the document.

It is further permissible to use a dictionary or similar document of reference in order to interpret a special term used in a document.

### 2. Implicit features or well-known equivalents

A document takes away the novelty of any claimed subject-matter derivable directly and unambiguously from that document including any features implicit to a person skilled in the art in what is expressly mentioned in the document, e.g. a disclosure of the use of rubber in circumstances where clearly its elastic properties are used even if this is not explicitly stated takes away the novelty of the use of an elastic material. The limitation to subject-matter "derivable directly and unambiguously" from the document is important. Thus, when considering novelty, it is not correct to interpret the teaching of a document as embracing well-known equivalents which are not disclosed in the documents; this is a matter of obviousness.

### 3. Relevant date of a prior document

In determining novelty, a prior document should be read as it would have been read by a person skilled in the art on the relevant date of the document. By "relevant" date is meant the publication date in the case of a previously published document and the date of filing (or priority date, where appropriate) in the case of a document according to Art. 54(3) (see G-IV, 5.1).

#### **4. Enabling disclosure of a prior document**

Subject-matter described in a document can only be regarded as having been made available to the public, and therefore as comprised in the state of the art pursuant to Art. 54(1), if the information given therein to the skilled person is sufficient to enable him, at the relevant date of the document (see G-VI, 3), to practise the technical teaching which is the subject of the document, taking into account also the general knowledge at that time in the field to be expected of him (see T 26/85, T 206/83 and T 491/99).

Similarly, it should be noted that a chemical compound, the name or formula of which is mentioned in a prior-art document, is not thereby considered as known, unless the information in the document, together, where appropriate, with knowledge generally available on the relevant date of the document, enables it to be prepared and separated or, for instance in the case of a product of nature, only to be separated.

#### **5. Generic disclosure and specific examples**

In considering novelty, it should be borne in mind that a generic disclosure does not usually take away the novelty of any specific example falling within the terms of that disclosure, but that a specific disclosure does take away the novelty of a generic claim embracing that disclosure, e.g. a disclosure of copper takes away the novelty of metal as a generic concept, but not the novelty of any metal other than copper, and one of rivets takes away the novelty of fastening means as a generic concept, but not the novelty of any fastening other than rivets.

#### **6. Implicit disclosure and parameters**

In the case of a prior document, the lack of novelty may be apparent from what is explicitly stated in the document itself. Alternatively, it may be implicit in the sense that, in carrying out the teaching of the prior document, the skilled person would inevitably arrive at a result falling within the terms of the claim. An objection of lack of novelty of this kind should be raised by the examiner only where there can be no reasonable doubt as to the practical effect of the prior teaching (for a second non-medical use, however, see G-VI, 7). Situations of this kind may also occur when the claims define the invention, or a feature thereof, by parameters (see F-IV, 4.11). It may happen that in the relevant prior art a different parameter, or no parameter at all, is mentioned. If the known and the claimed products are identical in all other respects (which is to be expected if, for example, the starting products and the manufacturing processes are identical), then in the first place an objection of lack of novelty arises. The burden of proof for an alleged distinguishing feature lies with the applicant. No benefit of doubt can be accorded if the applicant does not provide evidence in support of the allegations (see T 1764/06). If, on the other hand, the applicant is able to show, e.g. by appropriate comparison tests, that differences do exist with respect to the parameters, it is questionable whether the application discloses all the features essential to



manufacture products having the parameters specified in the claims (Art. 83).

## 7. Examination of novelty

In determining novelty of the subject-matter of claims, the examiner should have regard to the guidance given in F-IV, 4.5 to 4.21. He should remember that, particularly for claims directed to a physical entity, non-distinctive characteristics of a particular intended use should be disregarded (see F-IV, 4.13). For example, a claim to a substance X for use as a catalyst would not be considered to be novel over the same substance known as a dye, unless the use referred to implies a particular form of the substance (e.g. the presence of certain additives) which distinguishes it from the known form of the substance. That is to say, characteristics not explicitly stated, but implied by the particular use, should be taken into account (see the example of a "mold for molten steel" in F-IV, 4.13). For claims to a first medical use, see G-II, 4.2.

A known compound is not rendered novel merely because it is available with a different degree of purity if the purity can be achieved by conventional means (see T 360/07).

### 7.1 Second or further medical use of known pharmaceutical products

Where a substance or composition is already known to have been used in a "first medical use", it may still be patentable under Art. 54(5) for any second or further use in a method according to Art. 53(c), provided that said use is novel and inventive.

Art. 54(4) and (5) thus provide for an exception from the general principle that product claims can only be obtained for (absolutely) novel products. However, this does not mean that product claims for the first and further medical uses need not fulfil all other requirements of patentability, especially that of inventive step (see T 128/82).

A claim in the form "Use of substance or composition X for the treatment of disease Y..." will be regarded as relating to a method for treatment explicitly excluded from patentability under Art. 53(c) and therefore will not be accepted. A claim in the form "Substance X for use as a medicament" is acceptable, even if X is a known substance, but its use in medicine is not known. Likewise, it is acceptable to have a claim in the form "Substance X for use in the treatment of disease Y", provided that such a claim involves an inventive step over any prior art disclosing the use of X as a medicament.

---

If an application discloses for the first time a number of distinct surgical, therapeutic or diagnostic uses for a known substance or composition, normally in the one application independent claims each directed to the substance or composition for one of the various uses may be allowed; i.e. an a priori objection of lack of unity of invention should not, as a general rule, be raised (see F-V, 7).

Art. 82

A claim in the form "Use of a substance or composition X for the manufacture of a medicament for therapeutic application Z" is allowable for either a first or "subsequent" (second or further) such application ("Swiss-type" claim), if this application is new and inventive (see G 5/83) and has a filing or earliest priority date before 29 January 2011. For applications filed on or after that date, if the invention is characterised by a second (or further) therapeutic use of a medicament, such an invention cannot be expressed as a "Swiss-type" claim (see Notice from the EPO in OJ EPO 2010, 514).

The effect of the different claim formulations on patentability is summarised in the table below:

<i>Examples</i>			
#	Claim	Patentable?	Article
A	Use of product X for the treatment of asthma	No	53(c)
B	1. Product X for use as a medicament [X known as e.g. herbicide] 2. Product according to claim 1 for use in the treatment of asthma	Yes (even if X is a known product, but its use in medicine is not known)	54(4)
C	Product X for use in the treatment of cancer*	Yes (even if case B is prior art, provided that such a claim is inventive over B and any other prior art)	54(5)
D	Product X for use in the treatment of leukaemia*	Yes (even if cases B and C are prior art, provided that D is inventive over B and C and any other prior art because leukaemia is a specific type of cancer)	54(5)

\* Note: The corresponding Swiss-type claims for cases C and D (required under EPC 1973) would be "The use of Product X for the manufacture of a medicament for the treatment of cancer/leukaemia".

In cases where an applicant simultaneously discloses more than one "subsequent" therapeutic use, claims of the above type directed to these different uses are allowable in the one application, but only if they form a single general inventive concept (Art. 82). Regarding use claims of the above type, it should also be noted that a mere pharmaceutical effect does not necessarily imply a therapeutical application. For instance, the selective occupation of a specific

receptor by a given substance cannot be considered in itself as a therapeutic application; indeed, the discovery that a substance selectively binds a receptor, even if representing an important piece of scientific knowledge, still needs to find an application in the form of a defined, real treatment of a pathological condition in order to make a technical contribution to the art and to be considered as an invention eligible for patent protection (see T 241/95). See also F-IV, 4.22, for the functional definition of a pathological condition.

### 7.1.1 Products that may be claimed for a further medical use

The scope of protection of use-related product claims under Art. 54(5) is limited to the substance or composition in the context of its medical use, which confers novelty and non-obviousness, if any, on the claimed product.

This principle applies only to substances and compositions and cannot be extended to other products. A claim directed to a device for an intended medical use (e.g. pacemaker or implantable chemical sensor for use in ...) must be construed as claiming a device which is suitable for that medical use (F-IV, 4.13).

### 7.1.2 Therapeutic uses pursuant to Art. 54(5)

The treatment of a disease with a substance or composition which is already known to be used for treating said disease, where the only difference from the known treatment is in the dosage regime, is a specific further medical use within the meaning of Art. 54(5) (see G 2/08). Thus, therapeutic uses of a substance/composition may be based not only on the treatment of a different disease but also on the treatment of the same disease by a different therapeutic method differing for example in the dosage, administration regime, group of subjects or route of administration (G 2/08).

A claim directed to the further therapeutic use of a substance/composition should indicate the illness/disease to be treated, the nature of the therapeutic compound used for that purpose and, if relevant for establishing novelty and inventive step, the subject to be treated. If the further therapeutic use relates to a different therapy of the same disease using the same substance/composition, the claim should also define all technical features of the therapy giving rise to the desired technical effect (G 2/08).

An independent claim directed to a further therapeutic use of a substance/composition which is based on the use of said product in the treatment of a different disease should be formulated as follows:

Substance X or Composition comprising X	for use	in a method for the treatment of Y, or in the therapy of Y, or in a method of treating Y, or in a method of therapy of Y, or as a medicament defined by its function, (e.g. as an anti-inflammatory medicament)
--	---------	--

The presence of the term "for use" is mandatory, to closely adhere to the wording of Art. 54(5).

If the further therapeutic use is based on the use of the same product in a different treatment of the same disease, the independent claim should be formulated as follows:

Substance X for use or Composition comprising X for use	in a method for the treatment of Y, or in the therapy of Y, or in a method of treating Y, or in a method of therapy of Y, or as a medicament defined by its function (e.g. as an anti-inflammatory medicament)	characterised in that/ wherein	other features (e.g. the substance /composition is administered topically, three times daily...)
---	---	-----------------------------------	--

Purpose-related product claims which do not define exclusively (see claim 4 in the table below) a medical use excluded from patentability under Art. 53(c) should be construed as claims directed to a product *per se* which is suitable for the claimed use.

The table below shows some examples of claims which do not define a further medical use within the meaning of Art. 53(c) ...

		... because ...
1. Substance X or Composition comprising X in/for	a method for the treatment of Y, or the therapy of Y, or a method of treating Y, or a method of therapy of Y, or the (topical) treatment of Y, or the (topical) therapy of Y	without the term "for use" it is not evident if the claim is directed to the product suitable for the specified use or if the claim is limited by the medical use

2. (Anti-inflammatory) medicament, or Pharmaceutical comprising substance X, or Composition comprising X	for topical treatment	the claim indicates neither a therapeutic role nor a therapeutic application of the claimed product. Moreover, without the term "for use" it is not evident if the claim is directed to the product suitable for the specified use or if the claim is limited by the medical use
3. Substance X or Composition comprising X	as an anti-inflammatory agent	without the term "for use" it is not evident if the claim is directed to the product suitable for the specified use or if the claim is limited by the medical use
4. Substance X or Composition comprising X	for use as an antifungal /antibacterial agent	the claim does not define a specific medical use of the claimed product. It encompasses non-medical uses, because antifungal/ antibacterial agents are also used in e.g. agriculture for treating plants

If the prior art discloses either the product *per se* in a form which could be considered suitable for the claimed use, or its first medical application, claims 1 to 4 would lack novelty. The novelty objection could be overcome by reformulating the claim as described above (first table of G-VI, 7.1.2).

These amendments may be proposed by the Examining Division in the Rule 71(3) communication without the need to consult the applicant beforehand (see C-V, 1.1, point (f)).

### 7.1.3 Diagnostic uses pursuant to Art. 54(5)

A suitable formulation of a diagnostic claim according to Art. 54(5) may read:

Substance X or Composition comprising X	for use in a method of diagnosis	"in vivo"	of disease Y
---	----------------------------------	-----------	--------------

The wording "in vivo" limits the scope of the claim to diagnostic methods which are excluded from patentability pursuant to Art. 53(c).

Purpose-related product claims which do not define a diagnostic use excluded from patentability under Art. 53(c) should be construed as claims directed to a product *per se* which is suitable for the claimed use.

The following table shows some examples of claims which do not define a diagnostic use within the meaning of Art. 53(c):

1. Substance X or Composition comprising X	for use in the diagnosis of disease Y, or for use in the "in vitro"/"ex vivo" diagnosis of disease Y
2. Substance X or Composition comprising X	for use as a contrast agent for imaging blood flow

Claims 1 and 2 would lack novelty over prior art disclosing either the product *per se* in a form which could be considered suitable for the claimed use, or its first medical application.

Claim 1 could be reformulated as "Use of [...] in the "in vitro/ex vivo" diagnosis of disease Y". If the application as filed discloses, either explicitly or implicitly, that the claimed diagnostic methods are to be carried out "in vivo", the wording of claim 1 could also be limited to encompass only "in vivo" methods, as described above.

Claim 2 could be reformulated as "Use of [...] as contrast agent for imaging blood flow".

Claims 1 and 2 could also be reformulated as method claims, e.g. "A method for in vitro/ex vivo diagnosing disease Y using substance X [...]" or "A method for diagnosing disease Y in a sample by using substance X [...]" or "A method of imaging blood flow using substance X [...]".

These amendments may be proposed by the Examining Division in the Rule 71(3) communication without the need to consult the applicant beforehand (see C-V, 1.1, point (f)).

#### **7.1.4 Surgical uses pursuant to Art. 54(5)**

A claim defining a second surgical use may read "Substance X for use in a method of intracardiac catheterisation as a protector of blood vessel walls".

Purpose-related product claims which do not define a surgical use excluded from patentability under Art. 53(c) should be construed as claims directed to a product *per se* which is suitable for the claimed use.

The following table shows an example of a claim which does not define a surgical use within the meaning of Art. 53(c):

1. Substance X or Composition comprising X	for use in a method for hair removal by laser radiation
---	--

The claim would lack novelty over prior art disclosing either the product *per se* in a form which could be considered suitable for the claimed use, or its first medical application.

The claim could be reformulated as "Use of [...] for hair removal by laser radiation" or as "Method for removing hair by laser radiation by using substance X [...]".

This amendment may be proposed by the Examining Division in the Rule 71(3) communication without the need to consult the applicant beforehand (see C-V, 1.1, point (f)).

#### 7.1.5 Dependent claims pursuant to Art. 54(5)

The wording of the dependent claims must clearly reflect their dependency on the independent claim. A suitable formulation may read:

Substance X or Composition comprising X	for use in the therapy of disease Y according to claim # or for use according to claim #	characterised in that/ wherein	other features (e.g. it is provided as water-soluble granulates)
--	---	--------------------------------------	--

In the following example, the dependent claim is not correctly formulated according to Art. 54(5).

Claim 1: Composition comprising X for use in the treatment of Y.

Claim 2: Composition according to claim 1, comprising 5 mg X.

The category of claim 2 is unclear and the dependency is doubtful. The claim appears to depend on a claim directed to a product *per se*.

The claim would also lack novelty over prior art disclosing a composition comprising 5 mg X, or a first medical application thereof.

The claim should be reformulated as indicated above by inserting "for use" between "Composition" and "according". This amendment may be proposed by the Examining Division in the Rule 71(3) communication without the need to consult the applicant beforehand (see C-V, 1.1, point (f)).

## 7.2 Second non-medical use

A claim to the use of a known compound for a particular purpose (second non-medical use) which is based on a technical effect should be interpreted as including that technical effect as a functional technical feature. Accordingly, said claim is not open to objection under Art. 54(1), provided that such technical feature has not previously been made available to the public (G 2/88, and G 6/88). The novelty of the use of the known compound for the known production of a known product cannot be deduced from a new property of the produced product. In such a case, the use of a compound for the production of a product has to be interpreted as a process for production of the product with the compound. It can be regarded as novel only if the process of production as such is novel (see T 1855/06). For claims to a second or further medical use, see G-II, 4.2.

## 8. Selection inventions

Selection inventions deal with the selection of individual elements, sub-sets, or sub-ranges, which have not been explicitly mentioned, within a larger known set or range.

- (i) In determining the novelty of a selection, it has to be decided, whether the selected elements are disclosed in an individualised (concrete) form in the prior art (see T 12/81). A selection from a single list of specifically disclosed elements does not confer novelty. However, if a selection from two or more lists of a certain length has to be made in order to arrive at a specific combination of features then the resulting combination of features, not specifically disclosed in the prior art, confers novelty (the "two-lists principle"). Examples of such selections from two or more lists are the selection of:
  - (a) individual chemical compounds from a known generic formula whereby the compound selected results from the selection of specific substituents from two or more "lists" of substituents given in the known generic formula. The same applies to specific mixtures resulting from the selection of individual components from lists of components making up the prior art mixture;
  - (b) starting materials for the manufacture of a final product;
  - (c) sub-ranges of several parameters from corresponding known ranges.
- (ii) A sub-range selected from a broader numerical range of the prior art is considered novel, if each of the following three criteria is satisfied (see T 198/84 and T 279/89):
  - (a) the selected sub-range is narrow compared to the known range;



- (b) the selected sub-range is sufficiently far removed from any specific examples disclosed in the prior art and from the end-points of the known range;
- (c) the selected range is not an arbitrary specimen of the prior art, i.e. not a mere embodiment of the prior art, but another invention (purposive selection, new technical teaching).

An effect occurring only in the claimed sub-range cannot in itself confer novelty on that sub-range. However, such a technical effect occurring in the selected sub-range, but not in the whole of the known range, can confirm that criterion (c) is met, i.e. that the invention is novel and not merely a specimen of the prior art. The meaning of "narrow" and "sufficiently far removed" has to be decided on a case-by-case basis. The new technical effect occurring within the selected range may also be the same effect as that attained with the broader known range, but to a greater extent.

- (iii) In the case of overlapping ranges (e.g. numerical ranges, chemical formulae) of claimed subject-matter and the prior art the same principles apply for the assessment of novelty as in other cases, e.g. selection inventions (see T 666/89). It has to be decided which subject-matter has been made available to the public by a prior art disclosure and thus forms part of the state of the art. In this context, it is not only examples, but the whole content of the prior art document which has to be taken into consideration. As to overlapping ranges or numerical ranges of physical parameters, novelty is destroyed by an explicitly mentioned end-point of the known range, explicitly mentioned intermediate values or a specific example of the prior art in the overlap. It is not sufficient to exclude specific novelty destroying values known from the prior art range, it must also be considered whether the skilled person, in the light of the technical facts and taking into account the general knowledge in the field to be expected from him, would seriously contemplate applying the technical teaching of the prior art document in the range of overlap. If it can be fairly assumed that he would do so, it must be concluded that no novelty exists. In T 26/85, the skilled person could not seriously contemplate working in the area of overlap, since the prior art surprisingly contained a reasoned statement clearly dissuading him from choosing said range, although the latter was claimed in said prior art. The criteria mentioned in (ii) above can be applied analogously for assessing the novelty of overlapping numerical ranges (see T 17/85). As far as overlapping chemical formulae are concerned, novelty is acknowledged if the claimed subject-matter is distinguished from the prior art in the range of overlap by a new technical element (new technical teaching), see T 12/90, point 2.6 of the reasons, for example a specifically

selected chemical residue which is covered in general terms by the prior art in the overlapping area, but which is not individualised in the prior art document. If this is not the case, then it must be considered whether the skilled person would seriously contemplate working in the range of overlap and/or would accept that the area of overlap is directly and unambiguously disclosed in an implicit manner in the prior art (see for example T 536/95). If the answer is yes, then novelty is lacking.

### **8.1 Error margins in numerical values**

The skilled person knows that numerical values relating to measurements are subject to measurement errors which place limits on their accuracy. For this reason, the general convention in the scientific and technical literature is applied: the last decimal place of a numerical value indicates its degree of accuracy. Where no other error margins are given, the maximum margin should be ascertained by applying the rounding-off convention to the last decimal place (see T 175/97), e.g. for a measurement of 3.5 cm, the error margin is 3.45-3.54. When interpreting ranges of values in patent specifications, the skilled person proceeds on the same basis.

### **9. Novelty of "reach-through" claims**

"Reach-through" claims are defined as claims attempting to obtain protection for a chemical product (and also uses thereof, compositions thereof, etc.) by defining that product functionally in terms of its action (e.g. agonist, antagonist) on a biological target such as an enzyme or receptor (see F-III, 9). In many such cases, the applicant functionally defines chemical compounds in this way by reference to a newly identified biological target. However, compounds which bind to and exercise this action on that biological target are not necessarily novel compounds simply because the biological target which they act on is new. Indeed in many cases, the applicant himself provides test results in the application whereby known compounds are shown to exert this action on the new biological target, thus demonstrating that compounds falling within the functional definition of the "reach-through" claim are known in the state of the art and so establishing that a reach-through claim relating to compounds defined in this way lacks novelty.

## Chapter VII – Inventive step

### 1. General

An invention is considered as involving an inventive step if, having regard to the state of the art, it is not obvious to a person skilled in the art. Novelty (see G-IV, 5) and inventive step are different criteria. The question – "is there inventive step?" – only arises if the invention is novel. Art. 56

### 2. State of the art; date of filing

The "state of the art" for the purposes of considering inventive step is as defined in Art. 54(2) (see G-IV, 1). It is to be understood as concerning such kind of information as is relevant to some field of technology (see T 172/03). It does not include later published European applications referred to in Art. 54(3). As mentioned in G-IV, 3, "date of filing" in Art. 54(2), means date of priority where appropriate (see F-VI). The state of the art may reside in the relevant common general knowledge, which need not necessarily be in writing and needs substantiation only if challenged (see T 939/92).

### 3. Person skilled in the art

The "person skilled in the art" should be presumed to be a skilled practitioner in the relevant field of technology, who is possessed of average knowledge and ability and is aware of what was common general knowledge in the art at the relevant date (see T 4/98, T 143/94 and T 426/88). He should also be presumed to have had access to everything in the "state of the art", in particular the documents cited in the search report, and to have had at his disposal the means and capacity for routine work and experimentation which are normal for the field of technology in question. If the problem prompts the person skilled in the art to seek its solution in another technical field, the specialist in that field is the person qualified to solve the problem. The skilled person is involved in constant development in his technical field (see T 774/89 and T 817/95). He may be expected to look for suggestions in neighbouring and general technical fields (see T 176/84 and T 195/84) or even in remote technical fields, if prompted to do so (see T 560/89). Assessment of whether the solution involves an inventive step must therefore be based on that specialist's knowledge and ability (see T 32/81). There may be instances where it is more appropriate to think in terms of a group of persons, e.g. a research or production team, rather than a single person (see T 164/92 and T 986/96). It should be borne in mind that the skilled person has the same level of skill for assessing inventive step and sufficient disclosure (see T 60/89, T 694/92 and T 373/94).

### **3.1 Common general knowledge of the skilled person**

Common general knowledge can come from various sources and does not necessarily depend on the publication of a specific document on a specific date. An assertion that something is common general knowledge need only be backed by documentary evidence (for example, a textbook) if this is contested (see G-IV, 2).

A single publication (e.g. a patent document, but also the content of a technical journal) cannot normally be considered as common general knowledge (see T 475/88). In special cases, articles in technical journals can be representative of common general knowledge (see T 595/90). This applies in particular to articles providing a broad review or survey of a topic (see T 309/88). For the skilled person addressing the problem of bringing together certain starting materials, the conclusions of research on these materials carried out by only a very few manufacturers form part of the relevant general technical knowledge, even if the studies in question have only been published in technical journals (see T 676/94). Another exception is that it can also be the information contained in patent specifications or scientific publications, if the invention lies in a field of research which is so new that the relevant technical knowledge is not yet available from textbooks (see T 51/87).

Basic textbooks and monographs can be considered as representing common general knowledge (see T 171/84); if they contain references which direct the reader to further articles dealing with specific problems, these articles too may be counted as part of such knowledge (see T 206/83). Here it should be remembered that information does not become common general knowledge because it has been published in a particular textbook, reference work, etc.; on the contrary, it appears in books of this kind because it is already common general knowledge (see T 766/91). This means that the information in such a publication must have already become part of common general knowledge some time before the date of publication.

### **4. Obviousness**

Thus the question to consider, in relation to any claim defining the invention, is whether before the filing or priority date valid for that claim, having regard to the art known at the time, it would have been obvious to the person skilled in the art to arrive at something falling within the terms of the claim. If so, the claim is not allowable for lack of inventive step. The term "obvious" means that which does not go beyond the normal progress of technology but merely follows plainly or logically from the prior art, i.e. something which does not involve the exercise of any skill or ability beyond that to be expected of the person skilled in the art. In considering inventive step, as distinct from novelty (see G-VI, 3), it is fair to construe any published document in the light of knowledge up to and including the day before the filing or priority date valid for the claimed invention and to have regard to all the knowledge generally available to the person skilled in the art up to and including that day.

## 5. Problem-and-solution approach

In order to assess inventive step in an objective and predictable manner, the so-called "**problem-and-solution approach**" should be applied. Thus deviation from this approach should be exceptional.

In the problem-and-solution approach, there are three main stages:

- (i) determining the "closest prior art",
- (ii) establishing the "objective technical problem" to be solved, and
- (iii) considering whether or not the claimed invention, starting from the closest prior art and the objective technical problem, would have been obvious to the skilled person.

### 5.1 Determination of the closest prior art

The closest prior art is that which in one single reference discloses the combination of features which constitutes the most promising starting point for a development leading to the invention. In selecting the closest prior art, the first consideration is that it should be directed to a similar purpose or effect as the invention or at least belong to the same or a closely related technical field as the claimed invention. In practice, the closest prior art is generally that which corresponds to a similar use and requires the minimum of structural and functional modifications to arrive at the claimed invention (see T 606/89).

In some cases there are several equally valid starting points for the assessment of inventive step, e.g. if the skilled person has a choice of several workable solutions, i.e. solutions starting from different documents, which might lead to the invention. If a patent is to be granted, it may be necessary to apply the problem-and-solution approach to each of these starting points in turn, i.e. in respect of all these workable solutions. In the event of refusal, however, it is sufficient to show, on the basis of one relevant piece of prior art in respect of at least one of these solutions, that the claimed subject-matter lacks an inventive step. In such a situation, there is no need to discuss which document is "closest" to the invention; the only relevant question is whether the document used is a feasible starting point for assessing inventive step (see T 967/97, T 558/00, T 21/08, T 308/09 and T 1289/09). This is valid even if the problem identified in a problem-solution reasoning may be different from the one identified by the applicant/patentee.

The closest prior art must be assessed from the skilled person's point of view on the day before the filing or priority date valid for the claimed invention.

In identifying the closest prior art, account should be taken of what the applicant himself acknowledges in his description and claims to be known. Any such acknowledgement of known art should be regarded

by the examiner as being correct, unless the applicant states he has made a mistake (see C-IV, 7.2(vii)).

## 5.2 Formulation of the objective technical problem

In the second stage, one establishes in an objective way the **technical problem** to be solved. To do this one studies the application (or the patent), the closest prior art and the difference (also called "the **distinguishing feature(s)**" of the claimed invention) in terms of features (either structural or functional) between the claimed invention and the closest prior art, identifies the technical effect resulting from the distinguishing features, and then formulates the technical problem.

Features which cannot be seen to make any contribution, either independently or in combination with other features, to the technical character of an invention are not relevant for assessing inventive step (see T 641/00). Such a situation can occur for instance if a feature only contributes to the solution of a non-technical problem, for instance a problem in a field excluded from patentability (see T 931/95). For the treatment of claims comprising technical and non-technical aspects see G-VII, 5.4.

In the context of the problem-and-solution approach, the technical problem means the aim and task of modifying or adapting the closest prior art to provide the technical effects that the invention provides over the closest prior art. The technical problem thus defined is often referred to as the "**objective technical problem**".

The objective technical problem derived in this way may not be what the applicant presented as "the problem" in his application. The latter may require reformulation, since the objective technical problem is based on objectively established facts, in particular appearing in the prior art revealed in the course of the proceedings, which may be different from the prior art of which the applicant was actually aware at the time the application was filed. In particular, the prior art cited in the search report may put the invention in an entirely different perspective from that apparent from reading the application only. Reformulation might lead to the objective technical problem being less ambitious than originally envisaged by the application. An example of such a case would be where the originally stated problem is the provision of a product, process or method demonstrating some improvement, but where there is no evidence that the claimed subject-matter is thereby improved over the closest prior art uncovered in the search; rather, there is only evidence with respect to more distantly related prior art (or possibly none at all). In this case, the problem has to be reformulated as the provision of an alternative product, process or method. The obviousness of the claimed solution to that reformulated problem must then be assessed in the light of the cited prior art (see T 87/08).

The extent to which such reformulation of the technical problem is possible has to be assessed on the merits of each particular case. As a matter of principle any effect provided by the invention may be used as

a basis for the reformulation of the technical problem, as long as said effect is derivable from the application as filed (see T 386/89). It is also possible to rely on new effects submitted subsequently during the proceedings by the applicant, provided that the skilled person would recognise these effects as implied by or related to the technical problem initially suggested (see G-VII, 11 and T 184/82).

It is noted that the objective technical problem must be so formulated as not to contain pointers to the technical solution, since including part of a technical solution offered by an invention in the statement of the problem must, when the state of the art is assessed in terms of that problem, necessarily result in an *ex post facto* view being taken of inventive activity (see T 229/85). Where the claim refers to an aim to be achieved in a non-technical field, however, this aim may legitimately appear in the formulation of the problem as part of the framework of the technical problem to be solved, in particular as a constraint that has to be met (see T 641/00, T 172/03 and G-VII, 5.4.1).

The expression "technical problem" should be interpreted broadly; it does not necessarily imply that the technical solution is an improvement to the prior art. Thus the problem could be simply to seek an alternative to a known device or process which provides the same or similar effects or is more cost-effective. A technical problem may be regarded as being solved only if it is credible that substantially all claimed embodiments exhibit the technical effects upon which the invention is based. Criteria for deciding whether lack of reproducibility of the claimed invention should be treated under Art. 56 or 83 are explained in F-III, 12.

Sometimes, the objective technical problem must be regarded as an aggregation of a plurality of "**partial problems**". This is the case where there is no technical effect achieved by all the distinguishing features taken in combination, but rather a plurality of partial problems is independently solved by different sets of distinguishing features (see G-VII, 6 and T 389/86).

### 5.3 Could-would approach

In the third stage the question to be answered is whether there is any teaching in the prior art as a whole that **would** (not simply could, but would) have prompted the skilled person, faced with the objective technical problem, to modify or adapt the closest prior art while taking account of that teaching, thereby arriving at something falling within the terms of the claims, and thus achieving what the invention achieves (see G-VII, 4).

In other words, the point is not whether the skilled person could have arrived at the invention by adapting or modifying the closest prior art, but whether he **would have done** so because the prior art incited him to do so in the hope of solving the objective technical problem or in expectation of some improvement or advantage (see T 2/83). Even an implicit prompting or implicitly recognisable incentive is sufficient to

show that the skilled person would have combined the elements from the prior art (see T 257/98 and T 35/04). This must have been the case for the skilled person before the filing or priority date valid for the claim under examination.

When an invention requires various steps to arrive at the complete solution of the technical problem, it should nevertheless be regarded as obvious if the technical problem to be solved leads the skilled person to the solution in a step-by-step manner and each individual step is obvious in the light of what has already been accomplished and of the residual task still to be solved (see T 623/97 and T 558/00).

#### 5.4 Claims comprising technical and non-technical aspects

It is legitimate to have a mix of technical and "non-technical" features appearing in a claim, and the non-technical features may even form a major part of the claimed subject-matter.

Inventive step, however, can be based only on technical features, which thus have to be clearly defined in the claim. Non-technical features, to the extent that they do not interact with the technical subject-matter of the claim for solving a technical problem, i.e. non-technical features "as such", do not provide a technical contribution to the prior art and are thus ignored in assessing inventive step.

The problem-solution approach is in principle applied as follows to this type of claim, in particular for computer-implemented inventions:

- (i) The non-technical aspects of the claim(s) are identified; a requirements specification (see G-VII, 5.4.1) is derived from the non-technical aspect(s) set out in the claims and the description so that the person skilled in the art of a technical field (e.g. an expert in computer science) is informed of the non-technical concept.
- (ii) The closest prior art is selected on the basis of the technical aspects of the claimed subject-matter and the related description, also taking into account the considerations defined in G-VII, 5.1.
- (iii) The differences from the closest prior art are identified.
  - (a) If there are none (not even non-technical differences), an objection under Art. 54 is raised.
  - (b) If the differences are not technical, an objection under Art. 56 is raised. The reasoning for the objection should be that the subject-matter of a claim cannot be inventive if there is no technical contribution to the art, i.e. if there is no technical problem solved by the claimed subject-matter vis-à-vis the closest prior art.



- (c) If the differences include technical aspects, the following applies: firstly, the objective technical problem is formulated, taking into account the requirements specification as under point (i) above; the solution of the objective technical problem must comprise the technical aspects of the identified differences; secondly, if the solution of the technical problem is obvious to the person skilled in the art, an objection under Art. 56 is raised.

Care should be taken to avoid missing any features that might contribute to the technical character of the claimed subject-matter, in particular when the wording of the claim is paraphrased for the purpose of analysis (T 756/06).

#### **5.4.1 "Requirements specification" in the formulation of the objective technical problem**

Features which do not contribute to the technical character or do not make any contribution, either independently or in combination with other features, to the technical solution of a technical problem are not relevant for assessing inventive step (see T 641/00). Such a situation may arise, for instance, if a feature contributes only to the solution of a non-technical problem, e.g. a problem in a field excluded from patentability.

Where aspects of a claim define an aim to be achieved in a non-technical field and thus do not contribute to the technical character of the invention, this aim may legitimately appear in the formulation of the objective technical problem in the form of a "requirements specification" (i.e. a complete description of the behaviour of the system to be developed) provided to the person skilled in a technical field as part of the framework of the technical problem that is to be solved, in particular as a constraint that has to be met. If no such objective technical problem is found, the claimed subject-matter does not satisfy at least the requirement for an inventive step because there can be no technical contribution to the art, and the claim is to be rejected on this ground.

The objective technical problem must be so formulated as not to contain pointers to the technical solution, since including part of a technical solution offered by an invention in the statement of the problem must, when the state of the art is assessed in terms of that problem, necessarily result in an *ex post facto* view being taken of inventive activity. The requirements specification is not deemed to belong to the prior art; it is merely used in the formulation of the technical problem.

### **6. Combining pieces of prior art**

In the context of the problem-solution approach, it is permissible to combine the disclosure of one or more documents, parts of documents or other pieces of prior art (e.g. a public prior use or unwritten general technical knowledge) with the closest prior art. However, the fact that

more than one disclosure must be combined with the closest prior art in order to arrive at a combination of features may be an indication of the presence of an inventive step, e.g. if the claimed invention is not a mere aggregation of features (see G-VII, 7).

A different situation occurs where the invention is a solution to a plurality of independent "partial problems" (see G-VII, 7 and 5.2). Indeed, in such a case it is necessary to separately assess, for each partial problem, whether the combination of features solving the partial problem is obviously derivable from the prior art. Hence, a different document can be combined with the closest prior art for each partial problem (see T 389/86). For the subject-matter of the claim to be inventive, it suffices however that one of these combinations of features involves an inventive step.

In determining whether it would be obvious to combine two or more distinct disclosures, the examiner should also have regard in particular to the following:

- (i) whether the content of the disclosures (e.g. documents) is such as to make it likely or unlikely that the person skilled in the art, when faced with the problem solved by the invention, would combine them - for example, if two disclosures considered as a whole could not in practice be readily combined because of inherent incompatibility in disclosed features essential to the invention, the combining of these disclosures should not normally be regarded as obvious;
- (ii) whether the disclosures, e.g. documents, come from similar, neighbouring or remote technical fields (see G-VII, 3);
- (iii) the combining of two or more parts of the same disclosure would be obvious if there is a reasonable basis for the skilled person to associate these parts with one another. It would normally be obvious to combine with a prior-art document a well-known textbook or standard dictionary; this is only a special case of the general proposition that it is obvious to combine the teaching of one or more documents with the **common general knowledge** in the art. It would, generally speaking, also be obvious to combine two documents one of which contains a clear and unmistakable reference to the other (for references which are considered an integral part of the disclosure, see G-IV, 5.1 and G-VI, 1). In determining whether it is permissible to combine a document with an item of prior art made public in some other way, e.g. by use, similar considerations apply.

## **7. Combination vs. juxtaposition or aggregation**

The invention claimed must normally be considered as a whole. When a claim consists of a "combination of features", it is not correct to argue that the separate features of the combination taken by themselves are

known or obvious and that "therefore" the whole subject-matter claimed is obvious. However, where the claim is merely an "aggregation or juxtaposition of features" and not a true combination, it is enough to show that the individual features are obvious to prove that the aggregation of features does not involve an inventive step (see G-VII, 5.2, last paragraph). A set of technical features is regarded as a combination of features if the functional interaction between the features achieves a combined technical effect which is different from, e.g. greater than, the sum of the technical effects of the individual features. In other words, the interactions of the individual features must produce a synergistic effect. If no such synergistic effect exists, there is no more than a mere aggregation of features (see T 389/86, and T 204/06).

For example, the technical effect of an individual transistor is essentially that of an electronic switch. However, transistors interconnected to form a microprocessor synergically interact to achieve technical effects, such as data processing, which are over and above the sum of their respective individual technical effects (see also G-VII, Annex, 2).

According to T 9/81, patentability has been accepted for a preparation in the form of a "kit-of-parts" in which the individual active compounds, representing known therapeutic agents, are physically separated, provided that the use of those compounds, either simultaneously, separately or sequentially, produces a new and unexpected joint therapeutic effect which cannot be attained by the compounds independently of each other.

#### **8. "Ex post facto" analysis**

It should be remembered that an invention which at first sight appears obvious might in fact involve an inventive step. Once a new idea has been formulated, it can often be shown theoretically how it might be arrived at, starting from something known, by a series of apparently easy steps. The examiner should be wary of *ex post facto* analysis of this kind. When combining documents cited in the search report, he should always bear in mind that the documents produced in the search have, of necessity, been obtained with foreknowledge of what matter constitutes the alleged invention. In all cases he should attempt to visualise the overall state of the art confronting the skilled person before the applicant's contribution, and he should seek to make a "real-life" assessment of this and other relevant factors. He should take into account all that is known concerning the background of the invention and give fair weight to relevant arguments or evidence submitted by the applicant. If, for example, an invention is shown to be of considerable technical value, and particularly if it provides a technical advantage which is new and surprising and which is not merely achieved as a bonus effect in a "one-way street" situation (see G-VII, 10.2), and this technical advantage can convincingly be related to one or more of the features included in the claim defining the

invention, the examiner should be hesitant in pursuing an objection that such a claim lacks inventive step.

## 9. Origin of an invention

While the claim should in each case be directed to technical features (and not, for example, merely to an idea), in order to assess whether an inventive step is present it is important for the examiner to bear in mind that an invention may, for example, be based on the following:

- (i) the devising of a solution to a known problem;

*Example:* the problem of permanently marking farm animals such as cows without causing pain to the animals or damage to the hide has existed since farming began. The solution ("freeze-branding") consists in applying the discovery that the hide can be permanently depigmented by freezing.

- (ii) the arrival at an insight into the cause of an observed phenomenon (the practical use of this phenomenon then being obvious);

*Example:* the agreeable flavour of butter is found to be caused by minute quantities of a particular compound. As soon as this insight has been arrived at, the technical application comprising adding this compound to margarine is immediately obvious.

Many inventions are of course based on a combination of the above possibilities - e.g. the arrival at an insight and the technical application of that insight may both involve the use of the inventive faculty.

## 10. Secondary indicators

### 10.1 Predictable disadvantage; non-functional modification; arbitrary choice

It should be noted that if the invention is the result of a foreseeable disadvantageous modification of the closest prior art, which the skilled person could clearly predict and correctly assess, and if this predictable disadvantage is not accompanied by an unexpected technical advantage, then the claimed invention does not involve an inventive step (see T 119/82 and T 155/85). In other words, a mere foreseeable worsening of the prior art does not involve an inventive step. However, if this worsening is accompanied by an unexpected technical advantage, an inventive step might be present. Similar considerations apply to the case where an invention is merely the result of an arbitrary non-functional modification of a prior-art device or of a mere arbitrary choice from a host of possible solutions (see T 72/95 and T 939/92).

### **10.2 Unexpected technical effect; bonus effect**

An unexpected technical effect may be regarded as an indication of inventive step. It must, however, derive from the subject-matter as claimed, not merely from some additional features which are mentioned only in the description. However, if, having regard to the state of the art, it would already have been obvious for a skilled person to arrive at something falling within the terms of a claim, for example due to a lack of alternatives thereby creating a "one-way street" situation, the unexpected effect is merely a bonus effect which does not confer inventiveness on the claimed subject-matter (see T 231/97 and T 192/82).

### **10.3 Long-felt need; commercial success**

Where the invention solves a technical problem which workers in the art have been attempting to solve for a long time, or otherwise fulfils a long-felt need, this may be regarded as an indication of inventive step.

Commercial success alone is not to be regarded as indicative of inventive step, but evidence of immediate commercial success when coupled with evidence of a long-felt want is of relevance provided the examiner is satisfied that the success derives from the technical features of the invention and not from other influences (e.g. selling techniques or advertising).

## **11. Arguments and evidence submitted by the applicant**

The relevant arguments and evidence to be considered by the examiner for assessing inventive step may either be taken from the originally-filed patent application or submitted by the applicant during the subsequent proceedings (see G-VII, 5.2, and H-V, 2.2 and 2.4).

Care must be taken, however, whenever new effects in support of inventive step are referred to. Such new effects can only be taken into account if they are implied by or at least related to the technical problem initially suggested in the originally filed application (see also G-VII, 5.2, T 386/89 and T 184/82).

#### *Example of such a new effect:*

The invention as filed relates to a pharmaceutical composition having a specific activity. At first sight, having regard to the relevant prior art, it would appear that there is a lack of inventive step. Subsequently, the applicant submits new evidence which shows that the claimed composition exhibits an unexpected advantage in terms of low toxicity. In this case, it is allowable to reformulate the technical problem by including the aspect of toxicity, since pharmaceutical activity and toxicity are related in the sense that the skilled person would always contemplate the two aspects together.

The reformulation of the technical problem may or may not give rise to amendment or insertion of the statement of the technical problem in the description. Any such amendment is only allowable if it satisfies the

conditions listed in H-V, 2.4. In the above example of a pharmaceutical composition, neither the reformulated problem nor the information on toxicity could be introduced into the description without infringing Art. 123(2).

## **12. Selection inventions**

The subject-matter of selection inventions differs from the closest prior art in that it represents selected sub-sets or sub-ranges. If this selection is connected to a particular technical effect, and if no hints exist leading the skilled person to the selection, then an inventive step is accepted (this technical effect occurring within the selected range may also be the same effect as attained with the broader known range, but to an unexpected degree). The criterion of "seriously contemplating" mentioned in connection with the test for novelty of overlapping ranges should not be confused with the assessment of inventive step. For inventive step, it has to be considered whether the skilled person would have made the selection or would have chosen the overlapping range in the hope of solving the underlying technical problem or in expectation of some improvement or advantage. If the answer is negative, then the claimed matter involves an inventive step.

The unexpected technical effect must apply to the entire range as claimed. If it occurs in only part of the claimed range, the claimed subject-matter does not solve the specific problem to which the effect relates, but only the more general problem of obtaining, for example, "a further product X" or "a further process Y" (see T 939/92).

## **13. Dependent claims; claims in different categories**

If the subject-matter of an independent claim is new and non-obvious, there is no need to investigate the novelty and non-obviousness of the subject-matter of any claims dependent thereon, except in situations where the subject-matter of a dependent claim has a later effective date than the independent claim and intermediate documents are to be considered (see F-VI, 2.4.3).

Similarly, if the subject-matter of a claim to a product is new and non-obvious there is no need to investigate the novelty and non-obviousness of the subject-matter of any claims for a process which inevitably results in the manufacture of that product or of any claims for a use of that product. In particular, analogy processes, i.e. processes which themselves would otherwise not involve an inventive step, are nevertheless patentable insofar as they provide a novel and inventive product (see T 119/82). It should, however, be noted that in cases where the product, process and use claims have different effective dates, a separate examination as to novelty and inventive step may still be necessary in view of intermediate documents.

**14. Examples**

The annex to this chapter gives examples of circumstances where an invention may be regarded as obvious or where it may involve an inventive step. It is to be stressed that these examples are only for illustrative purposes and that the applicable principle in each case is "was it obvious to a person skilled in the art?" (see G-VII, 5). Examiners should avoid attempts to fit a particular case into one of these examples if it is not clearly applicable. Also, the list is not exhaustive.

## Annex

### Examples relating to the requirement of inventive step – indicators

#### 1. Application of known measures?

1.1 Inventions involving the application of **known measures** in an obvious way and in respect of which an inventive step is therefore to be ruled out:

- (i) The teaching of a prior document is incomplete and at least one of the possible ways of "**filling the gap**" which would naturally or readily occur to the skilled person results in the invention.

*Example:* The invention relates to a building structure made from aluminium. A prior document discloses the same structure and says that it is of light-weight material but fails to mention the use of aluminium.

- (ii) The invention differs from the known art merely in the use of **well-known equivalents** (mechanical, electrical or chemical).

*Example:* The invention relates to a pump which differs from a known pump solely in that its motive power is provided by a hydraulic motor instead of an electric motor.

- (iii) The invention consists merely in a new use of a well-known material employing the **known properties** of that material.

*Example:* Washing composition containing as detergent a known compound having the known property of lowering the surface tension of water, this property being known to be an essential one for detergents.

- (iv) The invention consists in the substitution in a known device of a recently developed material whose properties make it plainly suitable for that use ("**analogous substitution**").

*Example:* An electric cable comprises a polyethylene sheath bonded to a metallic shield by an adhesive. The invention lies in the use of a particular newly developed adhesive known to be suitable for polymer-metal bonding.

- (v) The invention consists merely in the use of a known technique in a closely analogous situation ("**analogous use**").

*Example:* The invention resides in the application of a pulse control technique to the electric motor driving the auxiliary mechanisms of an industrial truck, such as a fork-lift truck, the use of this technique to control the electric propulsion motor of the truck being already known.



1.2 Inventions involving the application of **known measures** in a **non-obvious** way and in respect of which an inventive step is therefore to be recognised:

- (i) A known working method or means when used for a **different purpose** involves a new, **surprising effect**.

*Example:* It is known that high-frequency power can be used in **inductive** butt welding. It should therefore be obvious that high-frequency power could also be used in **conductive** butt welding with similar effect. However, if high-frequency power were used for the continuous conductive butt welding of coiled strip but without removing scale (such scale removal normally being necessary during conductive welding in order to avoid arcing between the welding contact and the strip), there is the unexpected additional effect that scale removal is found to be unnecessary because at high frequency the current is supplied in a predominantly capacitive manner via the scale which forms a dielectric. In that case, an inventive step would exist.

- (ii) A new use of a known device or material involves **overcoming technical difficulties** not resolvable by routine techniques.

*Example:* The invention relates to a device for supporting and controlling the rise and fall of gas holders, enabling the previously employed external guiding framework to be dispensed with. A similar device was known for supporting floating docks or pontoons but practical difficulties not encountered in the known applications needed to be overcome in applying the device to a gas holder.

## 2. Obvious combination of features?

2.1 Obvious and consequently **non-inventive combination** of features:

The invention consists merely in the **juxtaposition** or association of known devices or processes functioning in their normal way and not producing any non-obvious working inter-relationship.

*Example:* Machine for producing sausages consists of a known mincing machine and a known filling machine disposed side by side.

2.2 Not obvious and consequently **inventive combination** of features:

The combined features mutually support each other in their effects to such an extent that a new technical result is achieved. It is irrelevant whether each individual feature is fully or partly known by itself. However, if the combination of features is a bonus effect, e.g. as the result of a "one-way street" situation, the combination might lack an inventive step.

*Example:* A mixture of medicines consists of a painkiller (analgesic) and a tranquilliser (sedative). It was found that through the addition of the tranquilliser, which intrinsically appeared to have no painkilling effect, the analgesic effect of the painkiller was intensified in a way which could not have been predicted from the known properties of the active substances.

### 3. Obvious selection?

3.1 Obvious and consequently **non-inventive selection** among a number of known possibilities:

- (i) The invention consists merely in choosing from a number of **equally likely alternatives**.

*Example:* The invention relates to a known chemical process in which it is known to supply heat electrically to the reaction mixture. There are a number of well-known alternative ways of so supplying the heat, and the invention resides merely in the choice of one alternative.

- (ii) The invention resides in the choice of particular dimensions, temperature ranges or other parameters from a limited range of possibilities, and it is clear that these parameters could be arrived at by routine trial and error or by the application of **normal design procedures**.

*Example:* The invention relates to a process for carrying out a known reaction and is characterised by a specified rate of flow of an inert gas. The prescribed rates are merely those which would necessarily be arrived at by the skilled practitioner.

- (iii) The invention can be arrived at merely by a **simple extrapolation** in a straightforward way from the known art.

*Example:* The invention is characterised by the use of a specified minimum content of a substance X in a preparation Y in order to improve its thermal stability, and this characterising feature can be derived merely by extrapolation on a straight-line graph, obtainable from the known art, relating thermal stability to the content of substance X.

- (iv) The invention consists merely in **selecting** particular chemical compounds or compositions (including alloys) **from a broad field**.

*Example:* The prior art includes disclosure of a chemical compound characterised by a specified structure including a substituent group designated "R". This substituent "R" is defined so as to embrace entire ranges of broadly-defined radical groups such as all alkyl or aryl radicals either unsubstituted or

substituted by halogen and/or hydroxy, although for practical reasons only a very small number of specific examples are given. The invention consists in the selection of a particular radical or particular group of radicals from amongst those referred to as the substituent "R" (the selected radical or group of radicals not being specifically disclosed in the prior-art document since the question would then be one of lack of novelty rather than obviousness). The resulting compounds:

- (a) are neither described as having nor shown to possess any advantageous properties not possessed by the prior art examples; or
  - (b) are described as possessing advantageous properties compared with the compounds specifically referred to in the prior art, but these properties are ones which the person skilled in the art would expect such compounds to possess, so that he is likely to be led to make this selection.
- (v) The invention follows inevitably from developments in the prior art, in such a way that there was no choice between several possibilities (the "**one-way street**" situation).

*Example:* From the prior art it is known that when you reach a particular compound in a series of known chemical compounds, expressed in terms of the number of carbon atoms, there is a consistently increasing insecticidal effect as you move up the series. With regard to insecticidal effect, the next member of the series after the member previously known then lies in a "one-way street". If this member of the series, in addition to exhibiting the expected enhanced insecticidal effect, proves also to have the unexpected effect of being selective, i.e. of killing some insects but not others, it nevertheless remains obvious.

3.2 Not obvious and consequently **inventive selection** among a number of known possibilities:

- (i) The invention involves **special selection** in a process of particular operating conditions (e.g. temperature and pressure) within a known range, such selection producing **unexpected effects** in the operation of the process or the properties of the resulting product.

*Example:* In a process where substance A and substance B are transformed at high temperature into substance C, it was known that there is in general a constantly increased yield of substance C as the temperature increases in the range between 50 and 130 °C. It is now found that in the temperature range from 63 to 65 °C, which previously had not been explored, the yield of substance C was considerably higher than expected.

- (ii) The invention consists in selecting **particular** chemical compounds or compositions (including alloys) from a broad field, such compounds or compositions having **unexpected advantages**.

*Example:* In the example of a substituted chemical compound given at G-VII, Annex, 3.1(iv) above, the invention again resides in the selection of the substituent radical "R" from the total field of possibilities defined in the prior disclosure. In this case, however, not only does the selection embrace a particular area of the possible field, and result in compounds that can be shown to possess advantageous properties (see G-VII, 10 and H-V, 2.2) but there are no indications which would lead the person skilled in the art to this particular selection rather than any other in order to achieve the advantageous properties.

#### 4. Overcoming a technical prejudice?

As a general rule, there is an inventive step if the prior art leads the person skilled in the art away from the procedure proposed by the invention. This applies in particular when the skilled person would not even consider carrying out experiments to determine whether these were alternatives to the known way of overcoming a real or imagined technical obstacle.

*Example:* Drinks containing carbon dioxide are, after being sterilised, bottled while hot in sterilised bottles. The general opinion is that immediately after withdrawal of the bottle from the filling device the bottled drink must be automatically shielded from the outside air so as to prevent the bottled drink from spurting out. A process involving the same steps but in which no precautions are taken to shield the drink from the outside air (because none are in fact necessary) would therefore be inventive.

# **Part H**

## **Amendments and Corrections**



# Contents

## **Chapter I – The right to amend I-1**

## **Chapter II – Admissibility of amendments – general rules II-1**

<b>1.</b>	<b>Introduction</b>	<b>II-1</b>
<b>2.</b>	<b>Admissibility during examination procedure</b>	<b>II-1</b>
2.1	Before receipt of the search report - Rule 137(1)	II-1
2.2	After receipt of the search report - Rule 137(2)	II-1
2.3	After receipt of the first communication - Rule 137(3)	II-2
2.4	At an advanced stage of the proceedings	II-3
2.5	Amendments filed in reply to a Rule 71(3) communication	II-3
2.5.1	Criteria for admitting such amendments	II-3
2.5.2	Amendments filed in reply to Rule 71(3) invitation admitted	II-4
2.5.3	Amendments filed in reply to Rule 71(3) invitation rejected	II-4
2.5.4	Exceptional case where amendments must be admitted	II-4
2.5.5	Rule 137(4) applies to amendments filed at this stage	II-5
2.6	Further requests for amendment after approval	II-5
2.7	Late-filed requests after summons to oral proceedings in examination	II-6
2.7.1	Concept of "clear allowability"	II-6
2.7.2	Additional criteria for admissibility of requests	II-6
<b>3.</b>	<b>Admissibility in opposition procedure</b>	<b>II-7</b>
3.1	Amendments in reply to the notice of opposition	II-7
3.2	Amendments not related to the grounds of opposition	II-7
3.3	Amendments occasioned by national rights	II-8
3.4	Insistence on unallowable amendments	II-8

3.5	Late-filed requests in opposition proceedings	II-9
<b>4.</b>	<b>Amendments in limitation procedure</b>	<b>II-9</b>
<b>5.</b>	<b>Amendments required by Rule 62a and/or Rule 63</b>	<b>II-9</b>
<b>6.</b>	<b>Amendments directed to unsearched matter - Rule 137(5)</b>	<b>II-9</b>
6.1	Rule 62a and/or Rule 63 cases	II-10
6.2	Subject-matter taken from the description	II-10
<b>7.</b>	<b>Amendments in case of non-unity</b>	<b>II-11</b>
7.1	Restriction to a single, searched invention	II-11
7.2	Restriction to an unsearched invention	II-11
7.3	No restriction to a single invention or claims amended	II-12
7.4	Euro-PCT cases	II-13
7.4.1	Where the EPO does not perform a supplementary search	II-13
7.4.2	Where the EPO performs a supplementary search	II-13

### **Chapter III – Admissibility of amendments – other procedural matters** **III-1**

<b>1.</b>	<b>Introduction</b>	<b>III-1</b>
<b>2.</b>	<b>Procedure for amendments to documents</b>	<b>III-1</b>
2.1	Indication of amendments and their basis under Rule 137(4)	III-1
2.1.1	Rule 137(4) communication and response thereto	III-2
2.1.2	Amendments withdrawn or superseded in the Rule 137(4) period	III-3
2.1.3	Rule 137(4) and oral proceedings	III-4
2.1.4	Transitional provisions relating to Rule 137(4)	III-4
2.2	Amendment by submitting missing documents or by filing replacement pages	III-4
2.3	Amendments using copies	III-5
2.4	Amendments made by the EPO at the request of a party	III-5





2.5	Withdrawal of amendments/abandonment of subject matter	III-6
<b>3.</b>	<b>Auxiliary requests</b>	<b>III-6</b>
3.1	General principles	III-7
3.1.1	Sequence of requests	III-7
3.1.2	Obligation to give reasons	III-7
3.1.3	Neither main nor auxiliary requests allowable	III-7
3.1.4	Indication of amendments made in main and/or auxiliary requests in examination proceedings	III-7
3.2	In the search phase	III-8
3.3	In examination proceedings	III-8
3.3.1	Admissibility of auxiliary requests	III-8
3.3.1.1	Criteria for admissibility of auxiliary requests	III-8
3.3.1.2	Timeliness and structure of auxiliary requests	III-8
3.3.2	Preparing the decision	III-8
3.3.3	Complete text for auxiliary request not yet available	III-9
3.3.4	Complete text for auxiliary request available	III-9
3.3.5	Applicant does not approve the text proposed for grant	III-9
3.4	In opposition proceedings	III-9
3.4.1	Written procedure	III-10
3.4.2	Oral proceedings	III-10
3.5	In limitation proceedings	III-11
3.5.1	General principles	III-11
3.5.2	Written procedure	III-11
3.5.3	Oral proceedings	III-12
<b>4.</b>	<b>Different texts in respect of different Contracting States</b>	<b>III-12</b>
4.1	Dealing with different texts in examination	III-12
4.2	Different text in respect of the state of the art according to Art. 54(3) and Art. 54(4) under EPC 1973	III-13
4.2.1	Art. 54(3) and (4) EPC 1973 in opposition proceedings	III-13
4.3	Different text where a partial transfer of right has taken place pursuant to Art. 61 or Rule 78	III-14
4.3.1	Different text where a partial transfer of right takes place pursuant to Art. 61 in examination proceedings	III-14
4.3.2	Different texts where a transfer of the patent in respect of certain designated states takes place in opposition proceedings	III-14

4.3.3	Opposition cases with different texts where a partial transfer of rights by virtue of a final decision pursuant to Art. 61 and Rule 18(1) and Rule 18(2) took place in examination proceedings	III-14
4.4	Different text where a reservation has been entered in accordance with Art. 167(2)(a) EPC 1973	III-14
4.5	Different text where national rights of earlier date exist	III-14
<b>5.</b>	<b>Calculation of claims fees</b>	<b>III-15</b>

## **Chapter IV – Allowability of amendments – Art. 123(2) and (3) IV-1**

<b>1.</b>	<b>Introduction</b>	<b>IV-1</b>
<b>2.</b>	<b>Allowability of amendments under Art. 123(2)</b>	<b>IV-1</b>
2.1	Basic principle	IV-1
2.2	Field of application of Art. 123(2)	IV-1
2.3	Content of the application as "originally" filed – general rules	IV-2
2.3.1	Features described in a document cross-referenced in the description	IV-2
2.3.2	Missing parts of the description or missing drawings filed after the date of filing	IV-3
2.3.3	Claims filed after the date of filing	IV-3
2.3.4	Sequence listings filed after the date of filing	IV-3
2.3.5	Priority documents	IV-4
2.3.6	Cases in limitation proceedings where the application documents as filed are no longer available	IV-4
2.3.7	Citation of prior art in the description after the filing date	IV-5
2.3.8	Clarification of inconsistencies	IV-5
2.3.9	Trademarks	IV-5
2.4	Content of the application as "originally" filed – special applications	IV-5
2.4.1	Applications filed by reference to an earlier application	IV-5
2.4.2	Divisional applications	IV-5
2.4.3	Applications resulting from a decision under Art. 61	IV-6
2.4.4	International applications	IV-6
2.5	Assessment of "added subject-matter" – examples	IV-6

<b>3.</b>	<b>Allowability of amendments under Art. 123(3)</b>	<b>IV-7</b>
3.1	Basic principles	IV-7
3.2	Field of application	IV-7
3.3	Protection conferred by the patent as granted	IV-7
3.4	Version of the granted patent to be considered	IV-7
3.5	Assessment of impermissible extension of the protection conferred	IV-8
3.6	Conflicts between Art. 123(2) and Art. 123(3)	IV-8
3.7	Conflicts between Art. 123(3) and other requirements of the EPC	IV-9
<b>4.</b>	<b>Compliance of amendments with other EPC requirements</b>	<b>IV-9</b>
4.1	General principles	IV-9
4.2	In examination proceedings	IV-9
4.3	In opposition proceedings	IV-10
4.4	In limitation proceedings	IV-10
4.4.1	Art. 84	IV-10
4.4.2	Examination of the description and/or drawings	IV-10
4.4.3	Points to be disregarded	IV-11
	<b>Chapter V – Allowability of amendments – examples</b>	<b>V-1</b>
<b>1.</b>	<b>Introduction</b>	<b>V-1</b>
<b>2.</b>	<b>Amendments in the description</b>	<b>V-1</b>
2.1	Clarification of a technical effect	V-1
2.2	Introduction of further examples and new effects	V-1
2.3	Supplementary technical information	V-1
2.4	Revision of stated technical problem	V-2
2.5	Reference document	V-2
2.6	Alteration, excision or addition of text in the description	V-2

---

<b>3.</b>	<b>Amendments in claims</b>	<b>V-2</b>
3.1	Replacement or removal of a feature from a claim	V-2
3.2	Inclusion of additional features	V-3
3.2.1	Intermediate generalisations	V-3
3.3	Deletion of part of the claimed subject-matter	V-5
3.4	Broadening of claims	V-5
3.5	Disclaimer disclosed in the application as originally filed	V-6
<b>4.</b>	<b>Disclaimers not disclosed in the application as originally filed</b>	<b>V-6</b>
4.1	The subject-matter to be excluded is not disclosed in the application as originally filed (so-called undisclosed disclaimers)	V-6
4.2	The subject-matter to be excluded is disclosed in the application as originally filed	V-8
<b>5.</b>	<b>Amendments to drawings</b>	<b>V-8</b>
<b>6.</b>	<b>Amendments derived from drawings</b>	<b>V-9</b>
<b>7.</b>	<b>Changes in claim category</b>	<b>V-9</b>
7.1	Product claim to use claim	V-9
7.2	Product claim to method claim	V-9
7.3	Method claim to product claim	V-10
7.4	Method claim to use claim	V-10
<b>8.</b>	<b>Changes in the title</b>	<b>V-10</b>
<b>Chapter VI – Correction of errors</b>		<b>VI-1</b>
<b>1.</b>	<b>Introduction</b>	<b>VI-1</b>
<b>2.</b>	<b>Errors in bibliographic data</b>	<b>VI-1</b>
<b>3.</b>	<b>Errors in publication</b>	<b>VI-1</b>
<b>4.</b>	<b>Corrections of errors in application and patent documents during proceedings</b>	<b>VI-1</b>
4.1	Admissibility of corrections	VI-1

---

4.2	Allowability of corrections	VI-1
4.2.1	Correction of description, claims and drawings	VI-2
4.2.2	Missing parts of description and missing drawings filed as corrections under Rule 139	VI-2
4.3	Examples	VI-3
<b>5.</b>	<b>Correction of errors in decisions and related application and patent documents</b>	<b>VI-4</b>
5.1	Admissibility of corrections	VI-4
5.2	Allowability of correction of bibliographic data	VI-4
5.3	Correction of the translations of the claims	VI-5



## Chapter I – The right to amend

A European patent application or European patent may be amended in examination, opposition and limitation proceedings. With regard to amendments filed in such proceedings, there are a number of important aspects to consider. Firstly, amendments must be admissible, i.e. they must be admitted into the procedure by the competent department of the EPO. Secondly, amendments must be allowable, which means that they must not:

- (i) add to the application or patent subject-matter which was not disclosed in the application as originally filed (Art. 123(2))
- (ii) introduce other deficiencies (such as lack of clarity in the claims - Art. 84)
- (iii) extend the protection conferred by a granted patent (Art. 123(3)).

Chapters H-II and H-III deal with the admissibility of amendments, while Chapters H-IV and H-V deal with their allowability. Chapter H-VI is dedicated to the correction of evident errors in documents submitted to the EPO or in decisions of the Examining or Opposition Divisions.





## Chapter II – Admissibility of amendments – general rules

### 1. Introduction

How the admissibility of amendments is assessed will depend on the type of procedure (examination, opposition or limitation) and on the stage of the proceedings, as detailed in the following sections.

### 2. Admissibility during examination procedure

#### 2.1 Before receipt of the search report - Rule 137(1)

In the case of a European patent application filed directly at the EPO (not via the PCT), it is not possible for the applicant to amend the application before receiving the European search report (Rule 137(1)).

*Rule 137(1)*

In the case of a Euro-PCT application requiring a supplementary European search according to Art. 153(7), the applicant may amend the claims, description and/or drawings before the application is subject to the supplementary search either by maintaining amendments filed in the international phase under Art. 19 PCT and/or Art. 34(2)(b) PCT or by filing amendments on and/or after entry into the European phase under Rule 159(1)(b) and/or Rule 161(2) respectively (see also E-VIII, 3 and B-III, 3.3.2).

For replies to an invitation under Rule 62a or 63, see H-II, 5.

#### 2.2 After receipt of the search report - Rule 137(2)

After receiving the European search report and the search opinion, the applicant must respond to the search opinion (see B-XI, 8) and may, in his reply and of his own volition, amend the description, claims and drawings (see C-II, 3 and subparagraphs, and C-III, 3.2). Likewise, for applications for which no supplementary European search report is prepared (see B-II, 4.3) when entering the European phase from the PCT, the applicant is required to respond to the WO-ISA, IPER or SISR where the ISA and, if applicable, the IPEA or SISA was the EPO (see E-VIII, 3.1 and 3.2). This response to the WO-ISA, IPER or SISR may include amendments made by the applicant of his own volition to the description, claims and drawings. Thereafter, the applicant may amend the application only with the consent of the Examining Division.

*Rule 137(2)*

For applications:

*Rule 71(1)*

- (i) for which no search opinion is prepared (see B-XI, 1.1 and 7),
- (ii) for which a search opinion was prepared, but where the search report was drawn up before 1 April 2010 (in which case Rule 70a does not apply and the applicant is not required to respond to the search opinion), or

- (iii) which enter the European phase from the PCT, where the EPO was the ISA, IPEA or SISA and prepared a written opinion, but for which a communication under Rule 161 was already issued before 1 April 2010,

it is after receipt of the first communication from the examiner in examination proceedings that the applicant may "of his own volition, amend once the description, claims and drawings", provided that the amendment and his reply are filed within the time limit for replying to that communication.

### **2.3 After receipt of the first communication - Rule 137(3)**

Subsequent to the applicable event mentioned in H-II, 2.2, the applicant may amend only if the examiner consents to the amendments proposed. Giving the Examining Division this discretion is intended to ensure that the examination procedure is brought to a conclusion in as few actions as possible (see C-IV, 3). In exercising its discretion the Examining Division must consider all relevant factors; in particular, it must balance the applicant's interest in obtaining a patent which is legally valid and the EPO's interest in bringing the examination procedure to a close in an effective way (in accordance with the principles set out in G 7/93). Furthermore, the exercise of discretion under Rule 137(3) needs to be reasoned.

As an exception to Rule 137(3), paragraph (b) of Rule 164(2) provides for a right to amend the application in response to the results of any search under Rule 164(2). This means that the applicant may make amendments of his own volition once in response to the communication under Art. 94(3) to which the search results under Rule 164(2) are annexed (see also H-II, 7.4.1).

If an amendment is admissible, subsequent proceedings are based on the description, claims and drawings as amended. Consent to an amendment does not necessarily imply that the application as amended is free from any objection under the EPC. Distinctions should be drawn between different types of amendments.

#### *Art. 94(3)*

Amendments remedying a deficiency in response to the preceding communication must always be admitted, provided they do not give rise to some new deficiency. Amendments limiting a claim which is already considered allowable should normally be admitted. The same applies to amendments improving the clarity of the description or claims in a manner clearly desirable.

A further factor is the amount of alteration to the application documents involved. Extensive reworking of the description or claims may be a proper response to highly relevant further prior art of which the applicant has only just become aware (e.g. either through further citation by the examiner or through knowledge obtained from another source). Regarding less extensive amendments, the examiner should adopt a reasonable approach, trying to balance fairness to the

applicant against the need to avoid unnecessary delay and excessive and unjustified additional work for the EPO. In exercising his discretion under Rule 137(3), the examiner should bear in mind the length of the proceedings to date and whether the applicant has already had sufficient opportunity for amendments. He should refuse in particular amendments reintroducing deficiencies previously pointed out to and removed by the applicant.

Additional reasons for not admitting amendments according to Rule 137(3) include the non-admittance of:

- ✚ – auxiliary requests in certain circumstances (see H-III, 3.3.1), and
- a request filed in, or in preparation for, oral proceedings (see H-III, 2.1.3),

where this is for reasons of procedural economy (taking into account the applicant's right to comment according to Art. 113(1)), where Rule 137(4) is not complied with in respect of the request in question.

Additional limitations on possible amendments of the application may apply if the European or supplementary European search report was a partial one due to Rule 63 or restricted in accordance with Rule 62a (see H-II, 6 and subparagraphs). *Rule 62a*  
*Rule 63*  
*Rule 137(5)*

#### **2.4 At an advanced stage of the proceedings**

Any request by an applicant to replace the text of the application on the basis of which a patent could be granted by a text that has been extensively revised should be refused, unless the applicant gives good reasons for proposing the changes only at this stage in the proceedings. This applies particularly in cases where the Examining Division has indicated that a version of the claims proposed by the applicant is grantable and that the applicant has only to bring the description into line with that version. *Rule 137(3)*

#### **2.5 Amendments filed in reply to a Rule 71(3) communication**

If, in reply to the communication under Rule 71(3) and within the specified period, the applicant files a request for amendments under Rule 137(3) and/or a correction of errors under Rule 139, the procedure is as defined in C-V, 4. This applies regardless of whether the request is an explicit request for amendment or is drafted as an approval which is conditional on the filed amendments and/or corrections. *Rule 71(6)*

##### **2.5.1 Criteria for admitting such amendments**

Decision G 7/93 dealt with the criteria to be applied when examining the admissibility of late-filed amendments in examination. The particular case to which that decision relates arose when the rules were differently formulated, and in a situation where the applicant had already given his consent to the version proposed by the Examining

Division. However, what was said by the Enlarged Board in that case can be considered generally applicable to new requests put forward at a late stage of the proceedings, i.e. when the applicant has already had at least one opportunity to amend the application and the Examining Division has already completed substantive examination of the application (see T 1064/04).

*Rule 71(3)*  
*Rule 137(3)*

In particular, applying the principles of G 7/93 to amendments filed in response to the communication under Rule 71(3) (see C-V, 1 to 3) means that this communication does not constitute an opportunity for the applicant to call into question the outcome of the earlier procedure. In deciding whether to admit such amendments, a balance must be struck between the applicant's interest in obtaining a patent which is valid in all of the designated states and the EPO's interest in bringing the examination procedure to a close by the issue of a decision to grant the patent. At this stage of the proceedings, the substantive examination has already been completed and the applicant has had the opportunity to amend the application and therefore normally only those amendments which do not appreciably delay the preparations for grant of the patent will be admitted under Rule 137(3). It is, however, appropriate to admit separate sets of claims for one or more designated States that made a reservation under Art. 167(2) EPC 1973 (see H-III, 4.4) or for which prior national rights exist (see H-III, 4.5).

*Rule 71(6)*

#### **2.5.2 Amendments filed in reply to Rule 71(3) invitation admitted**

If the Examining Division gives its consent under Rule 137(3) to these amendments and/or the correction and considers them allowable without issuing a further communication under Art. 94(3), it issues a second communication under Rule 71(3) based on the amended/corrected text (see C-V, 4.6), after which it then proceeds to the grant of the patent pursuant to Art. 97(1).

*Rule 71a(2)*

#### **2.5.3 Amendments filed in reply to Rule 71(3) invitation rejected**

Where amendments or corrections are not admitted, or where they are admitted but not considered allowable, examination will be resumed (see C-V, 4.7).

*Rule 137(3)*

#### **2.5.4 Exceptional case where amendments must be admitted**

It should be noted that if no communication under Art. 94(3) has preceded the communication under Rule 71(3) and the application was one of the exceptional cases (i), (ii) or (iii) mentioned in H-II, 2.2, the applicant may amend the description, claims and drawings of his own volition (see C-III, 2.1, for the conditions any amendment must satisfy). If the Examining Division finds that these amendments are allowable, a second communication according to Rule 71(3) is issued based on the text as amended (see C-V, 4.6). However, if the Examining Division is of the opinion that the amendments are not allowable (a finding of inadmissibility with regard to these amendments not being possible), the examination procedure should normally be resumed in accordance with C-V, 4.7.

### **2.5.5 Rule 137(4) applies to amendments filed at this stage**

Any amendments filed in reply to the communication under Rule 71(3) must satisfy the requirements of Rule 137(4) by identifying the amendments and indicating the basis for them in the application as filed (see H-III, 2.1). If these requirements are not met and the application is of one of the types mentioned in H-III, 2.1.4, the Examining Division may send a Rule 137(4) communication before proceeding further (see H-III, 2.1.1). If the applicant replies to this communication in time, the Examining Division will then decide if it consents to the amendments and will proceed accordingly as indicated in C-V, 4.

### **2.6 Further requests for amendment after approval**

Once the applicant has approved the text communicated to him pursuant to Rule 71(3), by paying the fees and filing the translation of the claims, further requests for amendment will only exceptionally be admitted under the discretionary power of the Examining Division given by Rule 137(3). A clear example of an admissible request is where the applicant files separate sets of claims for designated States that made reservations under Art. 167(2) EPC 1973 (see H-III, 4.4) or for which prior national rights exist (see H-III, 4.5). Similarly, it is appropriate to admit minor amendments which do not require re-opening of the substantive examination and which do not appreciably delay the issue of the decision to grant (see G 7/93).

*Rule 71(5)*

*Rule 137(3)*

If amendments are filed and do not comply with the requirements of Rule 137(4), the examiner may send a communication under Rule 137(4) (see H-III, 2.1.1).

When exercising its discretion under Rule 137(3) an Examining Division must consider and balance the applicant's interest in obtaining a patent which is legally valid in all of the designated states and the EPO's interest in bringing the examination procedure to a close by the issue of a decision to grant the patent. The criteria for exercising its discretion under Rule 137(3) at this late stage are whether the request can be decided on in a reasonable period of time, and whether the amendments are allowable. If either of these criteria is not satisfied, the request for amendments should be refused by the Division in the exercise of its discretion according to Rule 137(3).

Refusal of amendments must be reasoned, and both Art. 113(1) and Art. 116(1) must be observed (see C-V, 4.7.1). It must be shown that the conditions defined in G 7/93 are not met. This means that arguments must be given as to why the amendments are not minor in nature but in fact necessitate resuming substantive examination while considerably delaying the issue of a decision to grant the patent.

However, once the decision to grant is handed over to the EPO's internal postal service for transmittal to the applicant, the Examining Division is bound by it (see G 12/91) and can only amend it to the limited extent provided for in Rule 140 (see H-VI, 5.1). In examination

*Rule 140*

procedure, this corresponds to the date on which the centrally generated Form 2006, "*Decision to grant a European patent pursuant to Art. 97(1) EPC*", is forwarded to the postal service. This date is shown at the bottom right-hand corner of Form 2006. The Examining Division is no longer competent to decide on a request for amendments or corrections under Rule 139 if the filing of the request and the completion of the proceedings occur on the same date (T 798/95).

## **2.7 Late-filed requests after summons to oral proceedings in examination**

### **2.7.1 Concept of "clear allowability"**

In examination procedure, the Division will apply the criterion of "clear allowability" in exercising its discretion under Rule 137(3) for treating requests filed late during the proceedings without proper justification (T 153/85).

Late-filed claims will not be admitted into the proceedings if they are not clearly allowable, i.e. they clearly do not satisfy the requirements of the EPC, because for example they clearly violate the requirements of Art. 123(2).

The "clear allowability" criterion is also applied to patent proprietors' late-filed requests in opposition proceedings (T 98/96).

### **2.7.2 Additional criteria for admissibility of requests**

If the applicant files a reasonable number of requests related to amendments before the final date set in accordance with Rule 116(2), such requests should be admitted into the proceedings (see also H-III, 3).

If these requests or additional requests are filed after the above final date, they are late-filed and will be subject to the "clear allowability" criterion (see H-II, 2.7.1). Thus, the Division should first consider the requests before deciding on their admissibility. The mere fact that they are filed late is not *per se* a reason for not admitting them. This issue will normally be dealt with during oral proceedings.

If, after discussions, the Division comes to the conclusion that the late-filed requests are not clearly allowable, it should not admit them under Rule 116(2) and 137(3) on the grounds that they do not contain subject-matter which is clearly allowable, i.e. because this subject-matter clearly does not meet requirements of the EPC (where the applicant does not attend the oral proceedings, see H-III, 3.3.2 and E-II, 8.3.3). In the decision, reasoning is also to be given as to why the specific requirement(s) is(are) clearly not met.

As far as the criterion for admitting late-filed amendments is concerned, the Examining Division's first step should be to consider whether the claims are clearly not allowable, for example because they

clearly violate the requirements of Art. 123(2). If the claims do not contain subject-matter which is clearly not allowable (i.e. they pass this first step in the examination of their admissibility), they should be admitted if they are then subsequently also found to satisfy the following criteria (T 1273/04):

- the amendments are clearly permissible under Art. 123(2), Art. 84, Rule 137(5) and, where applicable, Rule 139;
- the newly defined subject-matter constitutes a convergent development of the subject-matter which has been the subject of examination;
- the subject-matter of the amended claims is clearly new.

However, it should be borne in mind that a request filed in response to a change of the subject of the proceedings, e.g. when a further document is cited for the first time during the oral proceedings, has to be admitted under Rule 116(1) (T 951/97).

### **3. Admissibility in opposition procedure**

#### **3.1 Amendments in reply to the notice of opposition**

Any amendments made in opposition proceedings must be occasioned by the grounds for opposition specified in Art. 100. That is to say, amendments are admissible only if they are required in order to meet a ground for opposition. However, the ground for opposition does not actually have to have been invoked by the opponent. For example, in opposition proceedings admissibly opened on grounds of non-patentability, the patent proprietor can also submit amendments to remove added subject-matter. Opposition proceedings cannot be used merely to tidy up and improve the disclosure in the patent specification (see T 127/85). The mere addition of new claims to the claims as granted is inadmissible because such amendments cannot be said to meet a ground of opposition. However, the replacement of one independent claim as granted by multiple, e.g. two, independent claims each directed to a respective specific embodiment covered by the independent claim as granted is admissible if such a replacement is occasioned by grounds of opposition specified in Art. 100 (see T 223/97).

*Rule 80*

#### **3.2 Amendments not related to the grounds of opposition**

If the proprietor proposes amendments to the patent in reply to the grounds of opposition and the Opposition Division intends to maintain the patent in amended form, pursuant to those grounds, other amendments, not related to the grounds of opposition (e.g. corrections, clarifications), may be allowed provided that the patent thus amended still fulfils the requirements of the EPC and that the amendments are considered necessary and appropriate. In particular, if one part of a claim has been amended, it may be necessary or appropriate to amend other parts of the claim as well.

Moreover, where a "clarification" can be considered as a limitation of the claim, it would be admissible under Rule 80 and could form the basis for maintaining the patent in amended form, provided the other requirements of the EPC are also met by the amended text (with the exception of unity of invention - G 1/91). If the Division is of the opinion that such a limiting clarification is not necessary, it should consider that the practice of interpreting a claim in a contracting state may be quite different from that of the EPO, and hence the patentee may see a need for such a limiting clarification.

Such amendments, however, should not be proposed by the Opposition Division and they can only be taken into consideration up to the pronouncement of the decision (in oral proceedings) or until the date the decision is handed over to the EPO's internal postal service for transmittal to the parties (in written proceedings) (see G 12/91).

If an allowable request exists for maintenance of the opposed patent either as granted or in amended form, the following amendments should not be allowed:

- (a) filing of further claims (see T 829/93 and T 223/97);
- (b) comprehensive redrafting of the dependent claims;
- (c) comprehensive redrafting of the description.

In the absence of any amendments submitted by the patent proprietor with a view to meeting the grounds for opposition, there is no possibility to make any other amendments.

### **3.3 Amendments occasioned by national rights**

Apart from the above (H-II, 3.1 and 3.2), amendments occasioned by national rights of earlier date are admissible pursuant to Rule 138 (see also G-IV, 6, with the exception of withdrawing the designation, see H-III, 4.5).

### **3.4 Insistence on unallowable amendments**

If the patent proprietor requests amendments going beyond those permissible under Rule 80 (see H-II, 3.1 and 3.2), he should be invited to withdraw them. If he then maintains his request, it should not be admitted (for the reasoning see for example T 127/85, Headnote, and T 406/86, Headnote 1).

If, in addition to the request containing unnecessary amendments, there is an auxiliary request which meets the requirements of the Convention and in particular does not comprise amendments not complying with Rule 80, the decision must include the grounds for not admitting the higher ranking first request(s).

It may occur that there is only one request which would be allowable, but it comprises amendments which clearly do not comply with



Rule 80. If the amendments cannot be admitted, the Division should explain the situation to the patentee so that revocation of the patent solely under Rule 80 can be avoided.

### 3.5 Late-filed requests in opposition proceedings

With respect to how late-filed requests are dealt with in opposition proceedings, reference is made to E-V, 2.1 (general examples), and E-V, 2.2 (examples concerning oral proceedings).



## 4. Amendments in limitation procedure

For admissibility of amendments in the limitation procedure, reference is made to D-X.

### 5. Amendments required by Rule 62a and/or Rule 63

Where the search was limited to certain subject-matter by application of Rule 63 (see B-VIII, 3.1 and 3.2), the claims must be amended in such a way as to remove the unsearched subject-matter and the description adapted accordingly.

*Rule 63(3)*

Where the search was limited to certain claims by application of Rule 62a (see B-VIII, 4.1 and 4.2), the claims must be amended in such a way as to remove the unsearched independent claims and the description adapted accordingly. To this end, the claims may be amended, for example, by deleting an unsearched independent claim or, where this complies with Art. 123(2) and Art. 84, by making an unsearched independent claim dependent on another independent claim of the same category which *has* been searched.

*Rule 62a(2)*

In both of these cases, a specific amendment is necessary, unless the applicant can convincingly argue that the invitation sent under Rule 62a(1) and/or Rule 63(1) was not justified.

Such amendments may, however, be made only in examination proceedings or, preferably, in reply to the search opinion (see F-IV, 3.3). Since the applicant may not amend the claims before receipt of the search report (Rule 137(1)), any claims filed in reply to an invitation under Rule 62a or Rule 63 will be taken only as an indication of what the applicant wants the EPO to search and dealt with accordingly (see B-VIII, 3.2 and 4.2). The applicant will then have to confirm maintenance of these amendments formally on entry into the examination phase (see A-V, 2.2).

### 6. Amendments directed to unsearched matter - Rule 137(5)

Rule 137(5) sets out two further conditions for amendments to claims, namely that amended claims may not relate to (i) unsearched subject-matter which does not combine with the originally claimed invention or group of inventions to form a single general inventive concept and (ii) subject-matter not searched in accordance with Rule 62a and Rule 63 (see, however, H-II, 5).

### 6.1 Rule 62a and/or Rule 63 cases

*Rule 137(5)*

Amended claims may not relate to subject-matter not searched in accordance with Rule 62a or Rule 63. Consequently, the presence of this subject-matter in the description cannot be used as a basis for its re-introduction into the claims.

### 6.2 Subject-matter taken from the description

*Rule 137(5)*

Within the framework of Art. 123(2) and 82, Rule 137(5) should be construed as permitting any limitation of searched subject-matter which is unitary with the originally claimed subject-matter, irrespective of whether the technical feature(s) used for the limitation has/have been searched.

Thus, the addition to a claim of a technical feature which further defines an element that was already a feature of the original main claim or makes a contribution to the effect(s) of the features of the originally claimed invention(s) and which was expressly not searched but was disclosed in the context of the invention in the application as filed (usually in the description) will not result in an amended claim lacking a single general inventive concept with respect to the originally claimed invention(s). Consequently no objection under Rule 137(5) should be raised in these circumstances, even though an additional search may be required (see C-IV, 7.2).

If amended claims are directed to subject-matter which has not been searched because it only appeared in the description (and the Search Division did not find it appropriate to extend the search to this subject-matter, see B-III, 3.5) and which does not combine with the originally claimed and searched invention or group of inventions to form a single general inventive concept, such amendments are not admissible.

An objection under Rule 137(5) will normally arise if the applicant attempts to replace a technical feature contained in a claim with a different technical feature taken from the description.

An objection under Rule 137(5) would also arise if a technical feature taken from the description which has an effect unrelated to the effect(s) of the features of the originally claimed invention(s) were added to a claim. Such a situation could arise when the subject-matter originally claimed has to be amended in view of a novelty or inventive step objection resulting from a broad claim formulation and when the original broad claim is restricted by the addition of a technical feature from the description which had an effect not related to the effects of the features already present in the original set of claims, such that there is lack of unity between the new limited claim and the claims originally present.

If an objection under Rule 137(5) is to be raised, the applicant should be informed that he may continue to pursue such subject-matter only in the form of a divisional application under Art. 76.

The situation described above is different from amendments corresponding to an invention originally claimed but not searched under Rule 64 or Rule 164(1) or (2), which are dealt with in H-II, 7.2.

For Euro-PCT applications where the EPO acted as ISA or as SISA, the Examining Division has to issue an invitation under Rule 164(2) for non-searched inventions contained in the application documents which are to serve as the basis for examination upon expiry of the six-month time limit set in the communication under Rule 161 or 162, even if these inventions were imported from the description (see C-III, 2.3).

However, applicants should bear in mind that the examining procedure should be brought to a conclusion in as few actions as possible. So the Examining Division may exercise its right not to admit further amendments under Rule 137(3) (see H-II, 2.3).

*Rule 137(3)*

## **7. Amendments in case of non-unity**

### **7.1 Restriction to a single, searched invention**

In reply to an objection of lack of unity, the applicant must restrict the claims to a single invention which has been searched. The examination can then be continued as for a unitary application but limited to that invention (see C-III, 3.1 and 3.2). However, if in response to a negative opinion concerning that invention the applicant later amends the claims to switch to a different searched invention, the Division will exercise its discretion under Rule 137(3) and refuse to admit the amendments since only one invention in each application can be examined for conformity with the requirements of the EPC (see G 2/92 and T 158/12).

### **7.2 Restriction to an unsearched invention**

If not all of the claimed inventions have been searched, in accordance with G 2/92 the applicant must restrict the claims to one of the searched inventions. If however in reply to the search opinion the applicant then restricts the claims to one of the originally claimed inventions which has not been searched, the examiner will write a first communication repeating the lack-of-unity objection raised in the search opinion. Any arguments of the applicant should be duly considered and dealt with in the communication.

If the application is restricted to an unsearched but originally claimed invention, it can be refused under Rule 64 in line with G 2/92 (subject to the applicant's rights under Art. 113(1) and Art. 116(1)).

Rule 137(5) cannot be invoked. It does not apply when the applicant has not paid the search fee in respect of a non-unitary invention relating to the originally filed claims.

If the application is a Euro-PCT application (see also H-II, 7.4) the examiner should, depending on the case:

- either object under Rule 164(2)(c) to the restriction of the claims to an invention searched neither (on grounds of lack of unity) by the EPO as (Supplementary) International Searching Authority nor as part of a search under Rule 164(2)(a),
- or object under Rule 164(1) in line with G 2/92 in the context of a supplementary search in the European phase (see B-II, 4.3.2, B-VII, 2.3 and E-VIII, 4.2).

In both cases, if the applicant declines to limit the claims to a searched invention, the application is refused under Rule 164 in accordance with G 2/92.

### **7.3 No restriction to a single invention or claims amended**

If in response to the search opinion the applicant does not restrict the application to a single invention searched, the objection of lack of unity raised at the search stage will be reviewed and if the examiner considers that it remains valid, a first communication repeating the lack-of-unity objection raised in the search opinion will be issued.

In Rule 164(2) cases, a lack of unity objection is addressed in the communication under Rule 164(2)(b) (see also H-II, 7.4.1).

If the applicant does not restrict the application at all, or does restrict it, but still maintains two or more inventions, the application can be refused under Art. 82 (subject to the applicant's rights under Art. 113(1) and 116(1)).

If the claims still cover an unsearched invention, an objection under Rule 64 would also apply, in line with decision G 2/92 as discussed in H-II, 7.2.

If the claims have not been simply restricted, but have instead, or additionally, been amended, such amendments can often result in the previously raised lack-of-unity objection no longer being valid, or in the arguments on which the objection was based no longer being complete. Such amendments would thus result in the objection having to be either withdrawn or at least newly argued.

Sometimes lack of unity of invention arises only during substantive examination, for example following an amendment of one or more claims so as to overcome an objection of lack of inventive step. In such situations the examiner should raise an objection, but only in very clear cases.

## 7.4 Euro-PCT cases

### 7.4.1 Where the EPO does not perform a supplementary search

Where the EPO does not perform a supplementary search, the application must be limited to an invention searched either in the international phase by the EPO or in the European phase in a search under Rule 164(2)(a). The above principles (H-II, 7.1 to 7.3) then apply *mutatis mutandis* (see also E-VIII, 4.2).

In Rule 164(2) cases, a further communication according to Art. 94(3) and Rules 71(1) and (2) repeating a lack of unity objection is not necessary, as a communication according to Art. 94(3) and Rules 71(1) and (2) addressing (also) unity of invention has already been issued under Rule 164(2)(b) (see also H-II, 2.3, and 7.2).

### 7.4.2 Where the EPO performs a supplementary search

Where the EPO performs a supplementary search on an application which is considered to lack unity, the applicant will be invited to pay additional fees, and the supplementary search report will be established for those inventions for which a search fee has been paid. The application must then be limited to one of the inventions searched in the supplementary search. The above principles (H-II, 7.1 to 7.3) then apply *mutatis mutandis* (see also E-VIII, 4.2).



## Chapter III – Admissibility of amendments – other procedural matters

### 1. Introduction

This chapter deals with procedural matters and formal requirements relating to the admissibility of amendments. An important requirement dealt with is the applicant's obligation to identify amendments and indicate the basis for them in the application as filed (Rule 137(4)). The chapter also deals with the format of and procedure for making amendments, as well as issues relating to auxiliary requests and how to deal with different texts for different contracting states.

### 2. Procedure for amendments to documents

#### 2.1 Indication of amendments and their basis under Rule 137(4)

When filing amendments, the applicant must identify them and indicate the basis for them in the application as filed. This requirement should be understood as an opportunity for the applicant to provide convincing arguments to the division as to why the amendment(s) is/are directly and unambiguously derivable from the application as filed. These arguments will be taken into account by the division for the assessment of Art. 123(2). They are particularly important for the outcome of the division's assessment where literal support for the amendment(s) is not present in the application as filed.

*Rule 137(4)*

The requirement that the basis for amendments be indicated is met if, on consulting those parts of the application indicated, it is not necessary to look further in order to assess the amendment's compliance with Art. 123(2). Non-specific indications such as "see the description as filed" or "see the claims as filed" or "see the examples as filed" are generally not considered sufficient. This requirement also applies in cases where the applicant requests the Examining Division to amend his application (see H-III, 2.4).

Whether the requirements of Rule 137(4) are met is assessed independently of whether the amendments in question comply with Art. 123(2). For example, the applicant may indicate that a particular amendment is based on a technical feature disclosed only in a schematic drawing. If the feature supposedly forming the basis for the amendment is indeed disclosed in the drawing indicated by the applicant, the requirements of Rule 137(4) are met, irrespective of whether the amendment based on that technical feature is allowable according to Art. 123(2) (see H-IV, 2.5).

Where the application was not filed in an official language of the EPO, in the absence of evidence to the contrary, for the purpose of assessing compliance with Art. 123(2) the EPO assumes that any translation of the application as filed is accurate. Consequently, in order to comply with Rule 137(4) it is sufficient to indicate the basis of an amendment in the translation of the application as filed.

*Rule 7*

**2.1.1 Rule 137(4) communication and response thereto***Rule 137(4)*

If the Examining Division notes a failure to meet either requirement of Rule 137(4), it may issue a communication requesting the correction of this deficiency within a period of one month. The amendments in respect of which such a communication may be sent include, *inter alia*:

- (i) claims filed after the date of filing under Rule 58 (see A-III, 15)
- (ii) amendments filed before entry into the European phase from the PCT under Art. 19 PCT and/or Art. 34 PCT (see E-VIII, 3)
- (iii) amendments filed on entry into the European phase from the PCT under Rule 159(1)(b) (see E-VIII, 3)
- (iv) amendments filed after entry into the European phase from the PCT under Rule 161(1) or Rule 161(2) (see E-VIII, 3)
- (v) amendments filed in response to the search opinion (see B-XI, 8)
- (vi) amendments filed during the examination procedure (see, however, H-III, 2.1.3), including those filed after the communication according to Rule 71(3).

Such a communication can only be sent in respect of amendments which are part of a current request. It cannot relate to amendments which have since been withdrawn or superseded.

*Art. 94(4)*

If the applicant fails to comply with this requirement within the above-mentioned period of one month, the application is deemed to be withdrawn due to the applicant's failure to reply to this communication from the Examining Division. The applicant may request further processing for failure to observe this time limit (see E-VII, 2.1).

If the amendments are filed in response to a communication according to Rule 71(3) and the requirements of Rule 137(4) are not satisfied in respect of them, the Examining Division may send a Rule 137(4) communication. Thereafter, if the applicant replies in time, the Examining Division will then decide whether to admit the amendments (see H-II, 2.5.5).

Where auxiliary requests are filed, a Rule 137(4) communication may also be sent in respect of one or more of the main and/or auxiliary requests. Alternatively, where Rule 137(4) is not complied with in respect of a specific request (main or auxiliary), this request may, for reasons of procedural economy and taking into account the applicant's right to be heard in accordance with Art. 113(1), be deemed inadmissible according to Rule 137(3).



### 2.1.2 Amendments withdrawn or superseded in the Rule 137(4) period

If the applicant replies in time to the Rule 137(4) communication by withdrawing the amendments in respect of which the communication was sent but without identifying those amendments or indicating their basis in the application as filed, then no loss of rights will occur according to Rule 137(4). However, where the withdrawal results in the re-introduction of subject-matter that has already been objected to, the amendment introducing this subject-matter may be deemed to be inadmissible according to Rule 137(3) (see H-II, 2.3).

No further Rule 137(4) communication will be sent in respect of further amendments filed in a timely response to the Rule 137(4) communication. By the expiry of the one-month period, the applicant must have identified and indicated the basis of:

- (i) amendments in respect of which the Rule 137(4) communication was sent and which are not superseded by further amendments filed during the one-month period under Rule 137(4), and
- (ii) amendments filed during that one-month period.

The applicant does not need to comply with Rule 137(4) in respect of amendments which are superseded by further amendments filed in the one-month period. For example:

03.06.2010	Application filed: 10 claims
25.03.2011	Extended European search report drawn up
21.08.2013	Amended claims 1-10 filed in examination proceedings, no basis indicated
03.09.2013	Examining Division sends a Rule 137(4) communication in respect of amended claims 1-10 filed on 21.08.2013
07.10.2013	Amended claims 6-10 filed
14.10.2013 (Monday)	One-month period under Rule 137(4) expires

In the above example, the applicant must, by expiry of the one-month period according to Rule 137(4) on 14.10.2013, indicate the basis for amended claims 1-5 as filed on 21.08.2013 and for amended claims 6-10 as filed on 07.10.2013, and failure to do so results in the application being deemed to be withdrawn according to Art. 94(4). It is not necessary for the applicant to indicate the basis for the superseded amendments to claims 6-10 filed on 21.08.2013. Note in particular that, where the basis for the amendments to claims 6-10 filed on 07.10.2013 is not indicated by 14.10.2013, then no further Rule 137(4) communication is sent in respect of these amendments and the application is deemed to be withdrawn on expiry of the one-month period on 14.10.2013.

### **2.1.3 Rule 137(4) and oral proceedings**

A Rule 137(4) communication will not be sent where the amendments in question are filed during oral proceedings. Nonetheless, it is a requirement of Rule 137(4) that amendments and their basis be identified. If the applicant fails to fulfil this requirement in respect of amendments filed during oral proceedings, the amendments may, for reasons of procedural economy and taking into account the applicant's right to be heard in accordance with Art. 113(1), be rejected as inadmissible by the Examining Division, exercising its discretion under Rule 137(3).

Amendments filed in preparation for oral proceedings in response to the summons thereto according to Rule 116(2) will be dealt with in those oral proceedings as indicated above. However, if the oral proceedings are cancelled or the applicant does not attend and the procedure is continued in writing after the oral proceedings are held in his absence, a Rule 137(4) communication may be sent by the Examining Division in respect of those amendments.

### **2.1.4 Transitional provisions relating to Rule 137(4)**

The above procedure applies to the following applications (see Art. 2(2) of the Decision of the Administrative Council of 25 March 2009, OJ EPO 2009, 299):

- (i) European applications for which the search report is drawn up on or after 1 April 2010,
- (ii) Euro-PCT applications for which the supplementary European search report is drawn up on or after 1 April 2010, and
- (iii) Euro-PCT applications for which the international search report is drawn up by the EPO acting as International Searching Authority on or after 1 April 2010 (Art. 153(6)).

## **2.2 Amendment by submitting missing documents or by filing replacement pages**

The content of a European patent application or patent may be amended within the limits laid down in Art. 123(2) and (3). (For the conditions governing amendments, see also A-V, 2, H-II, H-IV, H-V, and D-V, 6) This will normally be done by submitting missing documents or by filing replacement pages. Where replacement pages are filed the applicant or patent proprietor should, in the interests of procedural efficiency, identify clearly all amendments made, and indicate on which passages of the original application these amendments are based.

Amendments should preferably be identified using functions available in a text editor to clearly indicate deletions and insertions in the amended text. Pages with such indications should be submitted in addition to clean copies. Alternatively, handwritten form is appropriate

to fulfil the requirements of Rule 137(4), provided that clean copies are free from handwritten amendments.

The basis for amendments should preferably be indicated by including in the letter of reply a list of the amendments made and the precise basis for amendments in the originally filed documents. Where the basis is not explicit, e.g. where a different wording is used or features are taken only from drawings or generalised from a specific embodiment, a short explanation of why Art. 123(2) is fulfilled should be given.

### **2.3 Amendments using copies**

Amendments, particularly to the description or claims, may be made by using copies in accordance with the following procedure:

If he deems it expedient, the examiner or formalities officer may, on a copy of one or more pages of the documents to be amended, put forward suggestions as to how amendments should be made in such a way as to take account of the objections raised. The annotated copies (not the working documents which are to remain in the dossier) will then be forwarded to the applicant or, in opposition proceedings, to the proprietor of the patent and the other parties, in the communication setting out the objections. In this communication, the applicant or proprietor will not only be informed of the deficiencies recorded and invited to adopt a position or submit amendments within a fixed time limit, but will also be invited simultaneously to resubmit the said copy and – as an alternative to submitting replacement pages – to indicate on this copy, separately from the comments of the examiner (typewritten and in such a way as to be well legible after photocopying), any amendments to be made to the pages concerned. Opponents may also be invited to submit their comments in the same way.

The parties may also submit copies of one or more amended pages on their own initiative. The filing of completely retyped documents should normally be objected to, for reasons of procedural economy, as these documents will have to be checked for correspondence with the original documents (see T 113/92). Requests to this effect will, therefore, normally not be admitted under Rule 137(3). Only where the amendments are so extensive as to affect the legibility of the copies, replacement pages must be filed. In this case such pages may also be requested by the examiner on his own initiative.

### **2.4 Amendments made by the EPO at the request of a party**

Where necessary, deficient documents may also be amended at the request of a party by the competent department of the EPO. This could be the procedure for minor amendments, e.g. where it is necessary to insert details which were omitted in the request for grant, and the number of amendments involved is reasonable, or where whole pages or paragraphs are to be deleted. The party concerned should submit a list summarising the amendments to be undertaken by the EPO. It is, however, at the discretion of the examiner to decide whether the

number of changes requested is in fact unreasonable and would take a considerable amount of time to deal with. If so, the examiner will require that the party makes the amendments and submits amended pages. This procedure could also be followed for minor amendments to drawings, e.g. for amending a reference number or deleting one or more whole figures (as regards the removal of references following an amendment to the description, see F-II, 4.8). In the case of complicated amendments to drawings, where it is not immediately clear how the changes are to be made, the party concerned, who as a rule is the applicant or proprietor, must submit replacement pages.

### **2.5 Withdrawal of amendments/abandonment of subject matter**

Any subsequent request to withdraw an amendment is itself a request for further amendment; thus, if this subsequent request occurs after reply to the first communication from the examiner, the corresponding amendment will be admitted only if the examiner consents.

In deleting subject-matter from an application, the applicant should avoid any statement which could be interpreted as abandonment of that subject-matter. Otherwise the subject-matter cannot be reinstated (see J 15/85, confirmed in G 1/05 and G 1/06).

### **3. Auxiliary requests**

In examination, opposition and limitation proceedings, parties may submit a main request followed by one or more auxiliary requests (see also D-IV, 5.3).

#### *Example 1:*

"We request grant of a patent as per the documents originally filed or, alternatively, as per the amended documents now enclosed."

#### *Example 2:*

"We request that the opposition be rejected or, alternatively, that the patent be maintained in amended form as per the enclosed documents."

Such further (auxiliary) requests are made in case the Examining or Opposition Division cannot allow the main (first) request.

If in examination proceedings an applicant files text labelled as an auxiliary request, but also indicates that he is not yet willing to restrict himself to that request, the text should not be considered as a true auxiliary request within the meaning of this chapter, such that it would not be possible to proceed directly to the issue of a communication under Rule 71(3) based on this text (see C-V, 1.1). In such circumstances it would be appropriate to contact the applicant by telephone to establish whether he would be prepared to proceed to grant on the basis of that text. The applicant's agreement or non-agreement that a Rule 71(3) communication can be based on

such an auxiliary request must be mentioned in the minutes of the telephone conversation or, in the case of agreement, in the Rule 71(3) communication (see C-VII, 2.5).

### **3.1 General principles**

If the main request is allowable, the Division will ignore any auxiliary requests.

If the main request is not allowable, the Division will consider the auxiliary requests, in the sequence chosen by the requester.

If an auxiliary request is allowable, the Division will ignore all subsequent requests.

#### **3.1.1 Sequence of requests**

Under Art. 113(2), the EPO decides upon European patent applications or patents only in the text submitted to it, or agreed, by applicants or proprietors. These parties must therefore clearly indicate the text they are proposing or, if they are submitting more than one text, the sequence in which they want the EPO to consider them. Otherwise the Division does not know which version to base its decision on and would ultimately have to refuse the application, revoke the patent or reject the request for limitation for lack of any clear request.

#### **3.1.2 Obligation to give reasons**

In examination, opposition and limitation proceedings, whenever a request by any of the parties is refused, reasons must always be given.

#### **3.1.3 Neither main nor auxiliary requests allowable**

If the Examining or Opposition Division cannot allow the main request or any of the auxiliary requests, it must issue a decision to that effect, taking Art. 113(1) and 116 into account. The decision must include the reasons for rejecting/refusing the main request and each of the auxiliary requests, except where the requests in question have been withdrawn.

#### **3.1.4 Indication of amendments made in main and/or auxiliary requests in examination proceedings**

Where main and auxiliary requests are filed in examination proceedings and the applicant does not identify the amendments and/or does not indicate the basis for them in the application as filed, a communication according to Rule 137(4) may also be sent in respect of one or more of the main and/or auxiliary requests (see H-III, 2.1.1).

Alternatively, where Rule 137(4) is not complied with in respect of a specific request (main or auxiliary), this request may be rejected as inadmissible under Rule 137(3) (see H-III, 2.1.1). When exercising its discretion under Rule 137(3), an Examining Division must consider and balance the applicant's interest in obtaining a patent which is legally valid in all of the designated states and the EPO's interest in a

speedy conclusion of the proceedings. Furthermore, the exercise of discretion under Rule 137(3) needs to be reasoned.

### **3.2 In the search phase**

In the search phase, under Rule 137(1) amendments to the claims are not admissible before the applicant receives the European search report, and therefore no auxiliary requests can be submitted. If auxiliary requests are submitted before the establishment of a supplementary European search report (see H-II, 2.1), only the main request will be taken into account in the search (for exceptions where main and auxiliary requests are both considered at the search stage, see B-VIII, 3.2.2 and 4.2.2).

### **3.3 In examination proceedings**

#### **3.3.1 Admissibility of auxiliary requests**

##### **3.3.1.1 Criteria for admissibility of auxiliary requests**

As set out above, in this case the Examining Division must, when exercising its discretion under Rule 137(3) not to admit one or more auxiliary requests, balance the interests of the applicant and procedural efficiency.

Thus, an auxiliary request which contains minor deficiencies but otherwise complies with the requirements of the EPC should normally be admitted into the procedure.

When deciding on the admissibility of auxiliary requests the principles set out in H-II should be considered for each of the requests, since each request is in fact a set of amended claims.

Auxiliary requests reintroducing subject-matter which has already been considered unallowable and has been removed by the applicant will not be admitted (see also H-II, 2.3). The same may apply to auxiliary requests introducing new deficiencies.

##### **3.3.1.2 Timeliness and structure of auxiliary requests**

For late-filed requests, in addition to the criteria set out in H-II (in particular, H-II, 2.4, 2.5, 2.6 and 2.7), the subject-matter of the new claims should not diverge considerably from the claims already filed. The requests should normally represent a convergent development, i.e. the subject-matter of the auxiliary requests should constitute sequential limitations in the direction of an intended invention and should not make use of different characteristics in order to branch out in different directions (T 1273/04). Filing a large number of unstructured requests or requests involving different variants late in the procedure may lead to the requests not being admitted.

##### **3.3.2 Preparing the decision**

If the Examining Division is able to allow an auxiliary request (but not the main request or any higher-ranking auxiliary requests), it will inform

the applicant accordingly in a communication under Rule 71(2) or in an annex to the communication according to Rule 71(3), giving its reasons for refusing the main and higher-ranking auxiliary requests (see C-V, 1.1).

In oral proceedings, it may be appropriate to ask the applicant whether, in view of an allowable request, he would be prepared to withdraw the unallowable higher-ranking request(s). However, the applicant is not obliged to do so.

If auxiliary requests are submitted after the date set according to Rule 116(1) but the applicant/representative does not attend the oral proceedings, the Examining Division will apply the criteria set out in H-III, 3.3.1, in deciding on the admissibility of the auxiliary requests and may exercise its discretion under Rule 137(3) not to admit one or more of the requests (see H-II, 2.3, and H-III, 3.1.4), and it may do so in the absence of the applicant/representative.

### **3.3.3 Complete text for auxiliary request not yet available**

If a complete text corresponding to the allowable auxiliary request does not yet exist, the applicant must be asked to make the necessary amendments.

In oral proceedings, the Division should always try to have the description brought into line with the version of the claims it considers allowable. If necessary, the oral proceedings should be interrupted for this purpose.

### **3.3.4 Complete text for auxiliary request available**

If a complete text of the application according to the allowable auxiliary request already exists, a communication under Rule 71(3) is issued. In an annex to this communication the Division must give its reasons for refusing the higher-ranking requests (see also C-V, 1.1). Where appropriate, this may be done by reference to earlier communications. If the applicant approves this proposed text, then in accordance with Rule 71(3) he indicates this by filing the translations of the claims and paying the fees for grant and publishing without filing any request for amendment or correction of the proposed text (if such a request is filed, the procedure is as indicated in C-V, 4). If he does so, the application proceeds to grant on the basis of the text of the auxiliary request as proposed in the communication under Rule 71(3) (see C-V, 2).

### **3.3.5 Applicant does not approve the text proposed for grant**

If the applicant does not approve the text according to the auxiliary request as proposed in the communication under Rule 71(3), the procedure is as set out in C-V, 4 (see in particular C-V, 4.7 and 4.6.2).

## **3.4 In opposition proceedings**

In opposition proceedings, if an auxiliary request by the proprietor for maintenance of the patent in amended form is allowable, the Division cannot revoke the patent (see T 234/86).

### **3.4.1 Written procedure**

If the Opposition Division, after examining the parties' submissions, considers it can maintain the patent only in amended form as per an auxiliary request from the proprietor, it must first ensure that the parties have been allowed to comment under Art. 113(1) on the grounds and evidence behind the non-allowance of the higher-ranking request(s) and on the grounds and evidence behind the allowance of the lower-ranking request (where oral proceedings have been requested see also H-III, 3.5.2).

If, despite the existence of an allowable request, the proprietor continues to maintain one or more unallowable higher-ranking requests, an interlocutory decision is issued. This decision must include the finding that the patent and the invention to which it relates, as amended in accordance with the allowable auxiliary request, meet the requirements of the EPC. It must also set out the reasons, based on grounds and evidence already communicated to the parties, for refusing the higher-ranking requests and for allowing the lower-ranking request.

### **3.4.2 Oral proceedings**

If the Opposition Division is able to allow an auxiliary request but not the main or higher-ranking auxiliary requests, the chairman should inform the parties (possibly after interrupting the proceedings) which request is allowable and that the higher-ranking request(s) is/are not allowable (and on which grounds they are not allowable), ensuring beforehand that the parties have already had the opportunity to comment on all grounds and evidence underlying this finding. The chairman will then normally ask the proprietor if he is prepared to convert the allowable auxiliary request into a main request (by abandoning all higher-ranking unallowable requests). The Division cannot, however, insist on the proprietor making such a declaration.

If, despite the existence of an allowable auxiliary request, the proprietor continues to maintain higher-ranking unallowable requests, the Division issues an interlocutory decision to the effect that:

- (a) the main request and possibly one or more auxiliary requests is/are not allowable
- (b) in respect of the allowable auxiliary request, the amended patent and the invention to which it relates satisfy the requirements of the EPC.

If, on the other hand, the proprietor withdraws the higher-ranking requests such that the allowable auxiliary request becomes the main request, the Division will issue an interlocutory decision to the effect that this request satisfies the EPC.



The Division should try as far as possible to ensure that, if it allows an auxiliary request at oral proceedings, the complete final text is available at the end of the proceedings.

### **3.5 In limitation proceedings**

#### **3.5.1 General principles**

The filing of auxiliary requests (e.g. claim versions) together with a main request is possible in limitation proceedings, just as in examination proceedings. However, it should be remembered that there are restrictions with regard to the possibility of filing amendments in limitation proceedings (see D-X, 4.3 and 4.5).

The procedure to be applied, subject to any request for oral proceedings, is slightly different to that applicable in pre-grant proceedings under Rule 71(3), especially in view of the requirements of Art. 113(1) and (2). In particular, in a case where an auxiliary request is allowable and the main request is not, if this were communicated under Rule 95(3), this would no longer leave the requester the option of having his main request rejected with an appealable decision. Thus, the following applies:

- (a) if the main request is allowable, the invitation under Rule 95(3) to file the translations and pay the fees will be issued on that basis;
- (b) if an auxiliary request is allowable, but not the main request (and possibly other higher-ranking requests), the proprietor will be informed of the reasons in a communication under Rule 95(2) and invited to abandon the non-allowable request(s); if he does not do so, the request will be rejected as in (c) below;
- (c) if none of the requests is allowable, initially a communication under Rule 95(2) setting out the reasons and indicating a possible remedy is sent to the requester; if no remedy is undertaken, a decision rejecting the request is issued, and the annex prepared by the Examining Division will need to set out the reasons why none of the requests are allowable.

In cases (b) and (c), the decision may be appealed by the requester.

#### **3.5.2 Written procedure**

If the Examining Division, after examining the request for limitation, considers that the patent can be limited only on the basis of an auxiliary request, it informs the requester accordingly in a communication under Rule 95(2), giving reasons why the main request and any higher-ranking auxiliary requests are not allowable and informing the requester which auxiliary request is considered allowable. Where appropriate, the Division also informs the requester what amendments must be made to the patent specification documents to bring them into line (Art. 105b(1) and Rule 95(2)).

If in response to the communication under Rule 95(2) the requester withdraws his unallowable request(s) and (where applicable) makes any amendments still outstanding, the Examining Division will issue a communication under Rule 95(3) inviting him to pay the prescribed fee and to file the translation of the limited claims of the allowable request (see D-X, 5).

If the requester insists on maintaining an unallowable request, and fails to comply with the Examining Division's request that he file documents corresponding to the allowable auxiliary request, the request for limitation must be rejected (Art. 105b(2) and Rule 95(4)). The decision must give the reasons for not allowing the higher-ranking request(s) and must point out, as regards the allowable auxiliary request, that the requester failed to comply with the Division's request to submit a text enabling the patent to be limited on the basis of the allowable request.

### **3.5.3 Oral proceedings**

If the Examining Division is able to allow an auxiliary request but not the main or higher-ranking requests, the chairman should inform the requester (possibly after interrupting the proceedings) which request is allowable and why the higher-ranking request(s) is/are not. He will then normally ask the requester if he is prepared to convert the allowable auxiliary request into a main request. The Division cannot however insist on the requester making such a declaration.

If, despite the existence of an allowable text, the requester continues to maintain an unallowable higher-ranking request, the request for limitation shall be rejected (Rule 95(4)). The Division will issue a decision giving the reasons for not allowing the higher-preference requests and pointing out, as regards the allowable auxiliary request, that the requester failed to comply with its request to submit a text enabling the patent to be limited on the basis of the allowable request.

## **4. Different texts in respect of different Contracting States**

For limitation proceedings, see D-X, 10.

### **4.1 Dealing with different texts in examination**

A situation may arise in which, as a result of amendment, the application has two or more distinct sets of claims (see H-III, 4.2 to 4.5).

In examining the sets of claims referred to above, it will generally be found expedient to deal with each one quite separately, especially where the difference between them is substantial. The communication to the applicant will thus be divided into two or more parts, and the aim will be to have each set of claims, together with the description and drawings, brought into a state where it is in order to proceed to grant.

If the examiner considers that the description and drawings are so inconsistent with either set of claims as to create confusion, he should require the applicant to amend the description and drawings to remedy

this. If the applicant voluntarily proposes such amendment the examiner should admit it only if he considers it necessary. In particular, different descriptions and drawings will be required only if it is not possible to set out clearly in a common description which subject-matter is to be protected in the different Contracting States.

Hence this type of application will, after amendment, either consist of two or more distinct sets of claims each supported by the same description and drawings, or two or more sets of claims each supported by different descriptions and drawings.

#### **4.2 Different text in respect of the state of the art according to Art. 54(3) and Art. 54(4) under EPC 1973**

If the EPO notes that in respect of one or more of the designated Contracting States the content of an earlier European patent application forms part of the state of the art pursuant to Art. 54(3), two situations could arise:

- (i) the filing date of the application or patent under examination is before the date of entry into force of the EPC 2000. Art. 54(4) EPC 1973 is still transitionally applicable (see Art. 1, Decision of the Administrative Council of 28 June 2001, OJ EPO 2003 Special edition No. 1, 202). Here, if conflicting prior art gives rise to different texts of the claims, different sets of claims for the Contracting States concerned may be filed.
- (ii) the filing date of the application or patent under examination is on or after the date of entry into force of the EPC 2000. As Art. 54(4) EPC 1973 has been deleted, the conflicting prior art belongs to the state of the art for all Contracting States, irrespective of the effected designations. Likewise, it is irrelevant if the designation fee(s) for the earlier European patent application has/have been paid, since there is no provision in the EPC 2000 corresponding to Rule 23a EPC 1973. Consequently, the possibility of having different texts for different Contracting States on the basis of Art. 54(3) no longer exists.

##### **4.2.1 Art. 54(3) and (4) EPC 1973 in opposition proceedings**

The substance of H-III, 4.2, applies *mutatis mutandis* in opposition proceedings. The transitional provisions to the EPC 2000 require that, if the underlying application for a patent was filed before the date of entry into force of the EPC 2000, the conflicting prior art under Art. 54 be treated in accordance with EPC 1973, e.g. taking into account Art. 54(3) and (4) of EPC 1973 with the system of common designations. However for patents for which the underlying application was filed on or after the date of entry into force of the EPC 2000, the provisions of the latter apply, in which the system of common designations for conflicting prior art under Art. 54(3) no longer exists. Accordingly, different texts for different states are not acceptable any more for such patents (see F-II, 4.3 and H-III, 4.2).

Rule 138

### **4.3 Different text where a partial transfer of right has taken place pursuant to Art. 61 or Rule 78**

#### **4.3.1 Different text where a partial transfer of right takes place pursuant to Art. 61 in examination proceedings**

Art. 61(1)(b)  
Rule 17  
Rule 18(1) and (2)

If by a final decision pursuant to Art. 61 it is adjudged that a third party is entitled to the grant of a European patent in respect of only part of the matter disclosed in the European patent application, the original European patent application must contain, "where appropriate", for the designated Contracting States in which the decision was taken or recognised, claims, a description and drawings which are different from those for the other designated Contracting States (see also H-III, 4.1 and C-IX, 2).

#### **4.3.2 Different texts where a transfer of the patent in respect of certain designated states takes place in opposition proceedings**

Rule 78(2)

Where a third party has, in accordance with Art. 99(4), replaced the previous proprietor for one or some of the designated Contracting States (see D-I, 6, third paragraph), the patent as maintained in opposition proceedings may for those States contain claims, a description and drawings which are different from those for the other designated Contracting States, without, of course, going beyond the original disclosure.

#### **4.3.3 Opposition cases with different texts where a partial transfer of rights by virtue of a final decision pursuant to Art. 61 and Rule 18(1) and Rule 18(2) took place in examination proceedings**

The substance of H-III, 4.3.1, applies *mutatis mutandis*.

### **4.4 Different text where a reservation has been entered in accordance with Art. 167(2)(a) EPC 1973**

Art. 167(2)(a)  
EPC 1973

Where a Contracting State has entered reservations in accordance with Art. 167(2)(a) EPC 1973, patent applications and patents seeking protection for chemical, pharmaceutical or food products as such may include different sets of claims for that State and for the other designated States respectively. Such reservations were made by Austria, Greece and Spain. Without prejudice to Art. 167(5) EPC 1973, the reservation for Austria ceased to have effect after 7 October 1987, those for Greece and Spain after 7 October 1992 (for Spain, see Notice from the EPO dated 18 June 2007, OJ EPO 2007, 439).

Normally, a common description should be sufficient for all sets of claims.

### **4.5 Different text where national rights of earlier date exist**

Art. 139(2)

National rights of earlier date are not comprised in the state of the art (Art. 54) for the purposes of the EPO examination for patentability. Consequently, a specific search for national rights of earlier date is not made, although any documents found are mentioned in the search report (see B-VI, 4.2). However, under Art. 139(2), national rights of

earlier date can be invoked, after the grant of the European patent, in national proceedings as a ground for revocation. These rights represent exceptions to the uniformity of European substantive patent law. Where national rights exist, therefore, the applicant has a legitimate interest in submitting separate claims to ensure that the patent granted will not be partly revoked in some Contracting States. The filing of separate claims should, however, neither be required nor suggested.

If an applicant produces evidence in examination proceedings of the existence of pertinent national rights of earlier date in a particular designated State, it is appropriate to allow the submission of separate claims for the Contracting State in question (see H-II, 2.5 and 2.6). The evidence must be in the form of a printed specification or, where applicable, a copy of the utility model or utility certificate or of the application for it (see Art. 140); this is necessary to prevent unjustified deviation from the unity of the European patent.

The effect of the national right of earlier date is determined by the relevant national provisions. The examiner does not have to decide whether the applicant has, by means of separate claims, limited the scope of his application to the extent required. That is the responsibility of the applicant.

The examiner must check that the separate claims do not contravene Art. 123(2) and that they meet the other requirements of the EPC.

In contrast to European rights of earlier date, national rights of earlier date are not comprised in the state of the art, so there is no justification for a separate description. However, at a suitable point in the preamble to the description, preferably in a separate paragraph following the information pursuant to Rule 42(1)(a), a reference to this situation must be made, for example along the following lines:

"With reference to ... (e.g. earlier application No. ... in ...), the applicant has voluntarily limited the scope of the present application, and submitted separate claims for ... (Contracting State)."

## **5. Calculation of claims fees**

The claims fees are calculated in accordance with A-X, 11.2, C-V, 1.4, 4.2 and 4.8.1.



## **Chapter IV – Allowability of amendments – Art. 123(2) and (3)**

### **1. Introduction**

Chapters H-II and H-III deal with the admissibility of amendments, i.e. whether the competent department of the EPO will admit amended application or patent specification documents into the procedure. After an amendment has been admitted into the procedure, the competent department must then decide whether the amendment is allowable, i.e. whether it satisfies the requirements of the EPC. It is important to note that an admissible amendment is not automatically allowable.

### **2. Allowability of amendments under Art. 123(2)**

#### **2.1 Basic principle**

The question of allowability of amendments is legally a question of whether the application as so amended is allowable. An amended application must of course satisfy all the requirements of the EPC including, in particular, inventive step and the other matters listed in B-XI, 3.6 (see also C-III, 2).

If, however, the applicant seeks to amend the description (other than references to the prior art), the drawings or the claims in such a way that subject-matter which extends beyond the content of the application as filed is thereby introduced, the application as so amended cannot be allowed.

#### **2.2 Field of application of Art. 123(2)**

The underlying idea of Art. 123(2) is that an applicant is not allowed to improve his position by adding subject-matter not disclosed in the application as filed, which would give him an unwarranted advantage and could be damaging to the legal security of third parties relying on the content of the original application (see G 1/93). An amendment should be regarded as introducing subject-matter which extends beyond the content of the application as filed, and therefore unallowable, if the overall change in the content of the application (whether by way of addition, alteration or excision) results in the skilled person being presented with information which is not directly and unambiguously derivable from that previously presented by the application, even when account is taken of matter which is implicit to a person skilled in the art. At least where the amendment is by way of addition, the test for its allowability normally corresponds to the test for novelty given in G-VI, 2 (see T 201/83).

### 2.3 Content of the application as "originally" filed – general rules

Under Art. 123(2), it is impermissible to add to a European application subject-matter which is not directly and unambiguously derivable from the disclosure of the invention as filed, also taking into account any features implicit to a person skilled in the art in what is expressly mentioned in the document. Literal support is, however, not required by the wording of Art. 123(2) (see T 667/08).

The term "implicit disclosure" means no more than the clear and unambiguous consequence of what is explicitly mentioned in the application as filed. Thus, the common general knowledge must be taken into account in deciding what is clearly and unambiguously implied by the explicit disclosure of a document. However, the question of what may be rendered obvious by that disclosure in the light of common general knowledge is not relevant to the assessment of what is implicitly disclosed by that document (T 823/96).

When assessing the conformity of the amended claims to the requirements of Art. 123(2), the focus should be placed on what is really disclosed to the skilled person by the documents as filed as directed to a technical audience. In particular, the examiner should avoid disproportionately focusing on the structure of the claims as filed to the detriment of the subject-matter that the skilled person would directly and unambiguously derive from the application as a whole.

#### 2.3.1 Features described in a document cross-referenced in the description

Features which are not disclosed in the description of the invention as originally filed but which are only described in a cross-referenced document which is identified in such description are *prima facie* not within "the content of the application as filed" for the purpose of Art. 123(2). It is only under particular conditions that such features can be introduced by way of amendment into the claims of an application.

Such an amendment would not contravene Art. 123(2) if the description of the invention as originally filed leaves no doubt to a skilled reader (see T 689/90) that:

- (i) protection is or may be sought for such features;
- (ii) such features contribute to solving the technical problem underlying the invention;
- (iii) such features at least implicitly clearly belong to the description of the invention contained in the application as filed (Art. 78(1)(b)) and thus to the content of the application as filed (Art. 123(2)); and
- (iv) such features are precisely defined and identifiable within the disclosure of the reference document.



Moreover, documents not available to the public on the date of filing of the application can only be considered if (see T 737/90):

- (i) a copy of the document was available to the EPO, or to the receiving Office if the application is a Euro-PCT application which was not filed at the EPO as the receiving Office, on or before the date of filing of the application; and
- (ii) the document was made available to the public no later than on the date of publication of the application under Art. 93 (e.g. by being present in the application dossier and therefore made public under Art. 128(4)).

### **2.3.2 Missing parts of the description or missing drawings filed after the date of filing**

The procedure under Rule 56 allows the applicant to file missing drawings or parts of the description subsequently, and to rely on the priority document in order to avoid re-dating of the application to the date of filing of the missing parts. Under Rule 56(3), re-dating is only avoided where the missing parts were "completely contained" in the priority document (see C-III, 1 and A-II, 5). The provisions of Rule 56(3) apply only to the filing stage of the application, without further implications: in particular, it is not permissible at later stages of the procedure to rely on the priority documents to correct or amend the application as filed (in keeping with G 3/89 and G 11/91). For Euro-PCT applications a similar provision exists under Rule 20.6 PCT, whereby a review by the EPO as elected or designated Office is possible under Rule 82*ter* PCT.

*Rule 56*

Missing parts of the description and/or missing drawings allowed under Rule 56(3) are always considered to be part of the application documents "as originally filed".

### **2.3.3 Claims filed after the date of filing**

Claims filed after the date of filing under Rule 58 are never considered to be part of the application documents "as originally filed" and must therefore comply with the requirements of Art. 123(2) (see A-III, 15). For this reason, the examiner has to check that the claims satisfy the requirements of Art. 123(2), according to the same practice and standards as established in examination for amendments filed in other phases of the procedure (see H-V).

*Rule 58*

### **2.3.4 Sequence listings filed after the date of filing**

A standardised sequence listing filed after the date of filing does not form part of the description (Rule 30(2)). Such a standardised sequence listing is not published either as an annex to the application or together with the specification (see the Notice from the EPO dated 18 October 2013 concerning the filing of sequence listings, OJ EPO 2013, 542, IV.2).



Pages and electronic files disclosing sequences or constituting a non-standardised sequence listing which were filed at the date of filing are an integral part of the application as originally filed and are treated like any other parts of the description.

A subsequently filed standardised sequence listing may contain only the sequence information - in a standardised form - already contained in the original application, and in particular the number of sequences and their numbering should be the same as in the original description (above EPO Notice, section I.2.4). To this end the applicant must file a statement confirming that the subsequently filed standardised sequence listing does not include matter which goes beyond the content of the application as originally filed (Article 2(2) of the Decision of the President dated 28 April 2011 on the filing of sequence listings, OJ EPO 2011, 372). In line with this, a subsequently filed standardised sequence listing cannot be used to determine the originally disclosed content of the application, but only for search purposes (above EPO Notice, section I.2.5).

A subsequently filed standardised sequence listing is not to be examined for compliance with the requirements of Art. 123(2), as it is not part of the description.

Without prejudice to Rule 30, a sequence listing forming part of the description may be corrected or amended in accordance with Rule 139 and/or Art. 123(2). In this case a complete new sequence listing in TXT format containing the corrections or amendments is to be filed (Notice from the EPO dated 18 October 2013, OJ EPO 2013, 542, I.2.6).

### **2.3.5 Priority documents**

Under Art. 123(2) it is impermissible to add to a European application matter present only in the priority document for that application (see T 260/85), unless this is done under the provisions of Rule 56(3) (H-IV, 2.3.2). For correction of errors, see H-VI, 4.

### **2.3.6 Cases in limitation proceedings where the application documents as filed are no longer available**

In order to verify that the limitation introduced into the claim(s) meets the requirements of Art. 123(2), the application documents as filed are the ones to be considered. In rare cases where the patent to be limited is of an older date, it may happen that the original file is destroyed, with the result that the original application documents as filed are no longer available (see Rule 147 and the Decision of the President of the EPO dated 12 July 2007, Special edition No. 3, OJ EPO 2007, J.1). Examination of Art. 123(2) has then to be based on the available published application instead of the original application documents, on the assumption that it is identical in content to the application as filed.

### **2.3.7 Citation of prior art in the description after the filing date**

There is normally no objection to an applicant introducing, by amendment, further information regarding prior art which is relevant; indeed this may be required by the examiner (see F-II, 4.3 and F-III, 8). *Art. 123(2)*

### **2.3.8 Clarification of inconsistencies**

The straightforward clarification of an obscurity or the resolution of an inconsistency will normally not be objected to, provided that the clarification does not contravene the requirements of Art. 123(2).

### **2.3.9 Trademarks**

If an amendment is made in order to clarify the meaning of a trademark or to replace a registered trademark with a corresponding technical term, the examiner should be particularly careful to ascertain that the amendment does not conflict with Art. 123(2). The composition of a trademarked product may have changed over time.

## **2.4 Content of the application as "originally" filed – special applications**

### **2.4.1 Applications filed by reference to an earlier application**

According to Rule 40(1)(c), the applicant may file his European application by reference to a previously filed application (A-II, 4.1.3.1). Since claims are no longer required in order for a date of filing to be accorded, the applicant has three options:

- (i) when filing the European application, indicate that the reference to the previously filed application includes the claims
- (ii) at the time of filing, file a new set of claims together with an indication that the description and any drawings are filed by reference to a previously filed application
- (iii) when filing the European application, indicate the reference to a previously filed application and file the claims after the date of filing (Rule 58).

In cases (i) and (ii) the claims will form part of the application as originally filed, whereas in case (iii) the claims filed after the date of filing will not and will thus have to fulfil the requirements of Art. 123(2) (see H-IV, 2.3.3).

### **2.4.2 Divisional applications**

Under Art. 76(1), the subject-matter of a divisional application may not extend beyond the parent application as originally filed. Furthermore, amendments made to the divisional application subsequent to its filing may not extend beyond the content of the divisional application as originally filed (Art. 123(2); for more details see C-IX, 1.4).

### 2.4.3 Applications resulting from a decision under Art. 61

If, as a result of a final decision, it is adjudged that a person other than the applicant is entitled to the grant of a patent, that person may file a new European patent application under Art. 61(1)(b). In this case, the provisions of Art. 76(1) apply *mutatis mutandis* to the new application filed under Art. 61(1)(b).

This means that the new application must not contain any subject-matter extending beyond the earlier (unentitled) application as originally filed. Furthermore, Art. 123(2) means that this new application may not be amended in such a way as to extend its subject-matter beyond its content as originally filed, even where the subject-matter in question is contained in the earlier application (for more details see C-IX, 2.1).

### 2.4.4 International applications

For the purposes of Art. 123(2), the documents as originally filed are those originally filed in the PCT phase (normally published as a WO publication). Therefore amendments made during the PCT phase (including amended, substitute or rectified sheets, even if attached to the WO publication) or upon entry into the regional phase before the EPO must, if maintained in the European phase, fulfil the requirements of Art. 123(2), and all such amendments must be carefully considered.

### 2.5 Assessment of "added subject-matter" – examples

If an application relates to a rubber composition comprising several ingredients and the applicant seeks to introduce the information that a further ingredient may be added, then this amendment should normally be objected to as offending against Art. 123(2).

In the case of a disclosure of both a general and a preferred range, a combination of the preferred disclosed narrower range and one of the part-ranges lying within the disclosed overall range on either side of the narrower range may be derivable from the original disclosure of the application.

In an application which describes and claims an apparatus "mounted on resilient supports", without disclosing any particular kind of resilient support, objection should be raised if the applicant seeks to add the specific information that the supports are, or could be, e.g. helical springs.

If, however, the applicant were able to demonstrate that the drawings, as interpreted by the skilled person, show helical springs, the specific mention of helical springs would be allowable, at least in the context of the specific embodiment where it is disclosed (see also H-V, 3.2.1).

### 3. Allowability of amendments under Art. 123(3)

#### 3.1 Basic principles

The European patent as granted or as amended in opposition, limitation or revocation proceedings determines retroactively the protection conferred by the European patent application, insofar as such protection is not thereby extended. *Art. 69(2)*

Opposition proceedings will frequently give rise to amendments to the claims, following from grounds for opposition raised under Art. 100. Reasoned requests filed independently by the proprietor of the patent for an amendment to the claims, e.g. for limitation of the patent in view of an aspect of the state of the art which has come to his knowledge, may also result in amendments to the claims after examination by the Opposition Division.

In such cases the claims of the European patent may not be amended in such a way as to extend the protection conferred by the patent. *Art. 123(3)*

#### 3.2 Field of application

Art. 123(3) is directly aimed at protecting the interests of third parties by prohibiting any broadening of the claims of a granted patent, even if there should be a basis for such broadening in the application as filed (see G 1/93, Reasons 9).

#### 3.3 Protection conferred by the patent as granted

The extent of protection conferred by a European patent is determined by the claims. Nevertheless, the description and drawings are to be used to interpret the claims. *Art. 69(1)*

The Protocol on the Interpretation of Art. 69, which is, pursuant to Art. 164(1), an integral part of the EPC, specifies how Art. 69 is to be interpreted.

Since, pursuant to Art. 69(1), amendments to the description and drawings will also influence the interpretation of the claims, and may therefore extend the protection conferred, any such amendments extending protection in this way are not allowable (see G 1/93).

#### 3.4 Version of the granted patent to be considered

In order to verify the criteria of Art. 123(3) the examiner needs to compare the text of the amended claims with the claims of the patent as granted or as amended in opposition or earlier limitation proceedings, whichever claims are the most recent in force. This means that for the purposes of Art. 123(3) the amended claims are not necessarily compared to the claims as granted. When modified claims later replace the claims as granted (because of an opposition or earlier limitation(s)), the criterion for Art. 123(3) is applied with regard to the latest of these modified claims.

### 3.5 Assessment of impermissible extension of the protection conferred

In view of the above considerations, all amendments made to claims and any connected amendments to the description and drawings in the course of opposition proceedings, such as a change in the technical features of the invention, must be examined to determine whether such amendments could result in the extension of the subject-matter beyond the content of the application as originally filed (Art. 123(2)) or in the extension of the protection conferred (Art. 123(3)).

If, in view of Art. 84, the application documents have been adapted to amended claims before grant, thereby deleting part of the subject-matter originally disclosed in order to avoid inconsistencies in the patent specification, as a rule, subject-matter deleted for this reason cannot be reinserted either into the patent specification or into the claims as granted without infringing Art. 123(3) (the cut-off effect). An analogous finding applies to subject-matter retained in the patent specification during such adaptation for reasons of comprehensibility, but indicated as not relating to the claimed invention (see T 1149/97).

Special attention should be paid to the requirements of Art. 123(2) and Art. 123(3), which have to be dealt with separately:

- (a) Examination for compliance with Art. 123(2) is conducted in the same way as in examination proceedings.
- (b) Examination for compliance with Art. 123(3), on the other hand, is based on the claims as granted, or as amended in opposition or earlier limitation proceedings, where necessary using the description and drawings to interpret the claims (Art. 69 and the Protocol on the Interpretation of Art. 69).

### 3.6 Conflicts between Art. 123(2) and Art. 123(3)

A possible conflict between the requirements of Art. 123(2) and (3) may occur where, in the procedure before grant, a feature was added to the application which is considered unallowable under Art. 123(2) in opposition proceedings. In that case, Art. 123(2) would require deletion of such a feature whereas Art. 123(3) would not allow deletion, as this would extend the protection conferred by the patent as granted. In such a case the patent will have to be revoked under Art. 100(c). However, where this feature can be **replaced** by a feature for which there is a basis in the application as filed **and** which does not extend the protection conferred by the patent as granted, maintenance in this amended form can be allowed. If the added feature, **without providing a technical contribution to the subject-matter of the claimed invention**, merely limits the protection conferred by the patent as granted by excluding protection for part of the subject-matter of the claimed invention as covered by the application as filed, this feature may be maintained (see G 1/93). The technical significance of a feature in a claim is governed by its contribution to the technical definition of the claimed subject-matter, and that contribution is to be

assessed by the skilled person in the light of the original disclosure (see T 518/99).

### **3.7 Conflicts between Art. 123(3) and other requirements of the EPC**

Other requirements of the EPC may also interact with Art. 123(3) after grant. For instance, if a patent as granted only contains claims that in fact define a "method for treatment of the human or animal body by therapy or surgery practised on the human or animal body" or contain such a method step, and such a patent is opposed under Art. 53(c), then Art. 53(c) and 123(3) may operate in combination so that the patent must inevitably be revoked, in that: *Art. 123(3)*

- the patent cannot be maintained as granted because its claims define subject-matter which is excluded from patentability under Art. 53(c); and
- the patent cannot be maintained in amended form because amendment of the claims as granted by deletion of such "method features" would be contrary to Art. 123(3) (see T 82/93).

## **4. Compliance of amendments with other EPC requirements**

### **4.1 General principles**

The other EPC requirements with which amendments have to comply will depend on whether the amendments are filed in examination, opposition or limitation proceedings (see below).

### **4.2 In examination proceedings**

The question of allowability of amendments is legally a question of whether the application as so amended is allowable. An amended application must of course satisfy all the requirements of the EPC including, in particular, inventive step and the other matters listed in B-XI, 3.6 (see also C-III, 2). Also, however, especially when the claims have been substantially limited, the examiner should bear in mind that the following questions may require special consideration at the amendment stage.

#### **(i) Unity of invention**

Do the amended claims still satisfy the requirements of Art. 82? If the search report seems to reveal lack of novelty or inventive step in the concept common to all the claims, but the amended claims do not necessitate further search, the examiner should consider carefully whether an objection of lack of unity is justified at this stage of the proceedings (see F-V, 8). If, however, the claims lack a common inventive concept and a further search is necessary, objection should be raised.

(ii) Agreement of description and claims

If the claims have been amended, will the description require corresponding amendment to remove serious inconsistency between them? For example, is every embodiment of the invention described still within the scope of one or more claims? (see F-IV, 4.3). Conversely, are all of the amended claims supported by the description? (see F-IV, 6). Also, if the categories of claims have been altered, will the title require corresponding amendment (see H-V, 8)?

### 4.3 In opposition proceedings

The proprietor of the patent should, where this is not obvious, indicate the points in the original application documents or claims of the granted patent from which the amendments may be derived (Art. 100(c) and Art. 123(2)). In addition, he should file observations as regards the patentability of the subject-matter of the patent as amended (with reference to Art. 100(a) and (b)), taking into account the state of the art and objections raised in the opposition notice together, where appropriate, with the evidence presented in support.

Opposition is not an opportunity to re-examine the whole patent; it is the amendments introduced into the patent which must be examined as to whether they comply with the EPC as a whole (see T 227/88, T 301/87 and T 472/88). Therefore the Opposition Division should check that the patent, by the amendments themselves, does not contravene the requirements of the EPC (with the exception of Art. 82, see G 1/91 and D-V, 2). With respect to Art. 84, see D-V, 5. For the form of amended documents, see H-III, 2.2 to 2.4. It should be noted that the formal requirements, in particular Rules 30 to 34 and Rules 42, 43, 46, 48 and 50, must be satisfied (see Rule 86).

### 4.4 In limitation proceedings

Limitation is not an opportunity to re-examine the whole patent; only the amended claims are to be examined with regard to Art. 84, and Art. 123(2) and (3), i.e. what should be considered is whether the requested amendments introduce a deficiency within the meaning of those provisions. Claims as granted or as maintained should not be examined anew.

#### 4.4.1 Art. 84

It should also be verified that the amended claims are in conformity with Art. 84. For the interpretation of clarity under Art. 84 in limitation proceedings, the usual standards apply (see F-IV, 4, 5 and 6). Note in this respect that mere clarifications made to the claims, in particular to dependent claims, cannot be allowed, unless they are necessitated by the limitation(s) introduced elsewhere in the claims.

#### 4.4.2 Examination of the description and/or drawings

Rule 95(2) requires only the amended claims to be examined in limitation proceedings. Nonetheless, if the applicant has not filed



amendments to the description, the examiner should check whether the amended claims are still supported by the description. If this is not the case, in accordance with Rule 95(2) the proprietor should be requested to amend either the description or the claims, in order to comply with Art. 84. In this context it is pointed out that the examiner may not adapt the description of his own motion.

If, however, for the purpose of limitation an amended description and/or drawings are presented together with the claims, these are to be checked, but only for compliance with the requirements of Art. 123(2) and (3) and Art. 84. Note that in this respect amendments made to the description solely in order to improve the patent, or cosmetic changes which are not necessitated by the limited claims, cannot be allowed.

#### **4.4.3 Points to be disregarded**

In limitation proceedings there is no examination as to why a request for limitation was filed or whether the goal of the limitation has been achieved, for example if the amended and limited claims are truly novel vis-à-vis a particular prior art document.

In general there is no need to verify whether the limited claims contravene any of Art. 52 to 57. It may however happen that limitation results in *prima facie* non-compliance with the patentability criteria, e.g. Art. 53, in which case the examiner will communicate this non-compliance to the requester.

#### *Examples:*

A granted claim directed to a generic plant is limited to a specific plant variety, which would be an exception to patentability (Art. 53(b) and G 1/98). A claim granted to a device comprising a controlled explosion system is limited to a claim reciting an anti-personnel mine comprising the controlled explosion system, which would be contrary to Art. 53(a).



## Chapter V – Allowability of amendments – examples

### 1. Introduction

Chapter H-V provides additional guidance and examples relating to a number of typical situations where compliance with Art. 123(2) and/or Art. 123(3) is an issue. However, it must be borne in mind that the allowability of a specific amendment is ultimately to be decided on a case-by-case basis.

### 2. Amendments in the description

#### 2.1 Clarification of a technical effect

Where a technical feature was clearly disclosed in the original application but its effect was not mentioned or not mentioned fully, yet it can be deduced without difficulty by a person skilled in the art from the application as filed, subsequent clarification of that effect in the description does not contravene Art. 123(2).

#### 2.2 Introduction of further examples and new effects

Amendment by the introduction of further examples should always be looked at very carefully in the light of the general considerations outlined in H-IV, 2. The same applies to the introduction of statements of new (i.e. previously not mentioned) effects of the invention such as new technical advantages. For example, if the invention as originally presented related to a process for cleaning woollen clothing consisting of treating the clothing with a particular fluid, the applicant should not be allowed to introduce later into the description a statement that the process also has the advantage of protecting the clothing against moth damage.

*Art. 123(2)*

Under certain circumstances, however, later filed examples or new effects, even if not allowed into the application, may nevertheless be taken into account by the examiner as evidence in support of the patentability of the claimed invention. For instance, an additional example may be accepted as evidence that the invention can be readily applied, on the basis of the information given in the originally filed application, over the whole field claimed (see F-IV, 6.3). Similarly a new effect may be considered as evidence in support of inventive step, provided that this new effect is implied by or at least related to an effect disclosed in the originally filed application (see G-VII, 10).

*Art. 123(2)*

#### 2.3 Supplementary technical information

Any supplementary technical information submitted after the filing date of the application will be added to the part of the file which is open to public inspection, unless excluded from public inspection pursuant to Rule 144(d). From the date on which the information is added to the open part of the file, it forms part of the state of the art within the meaning of Art. 54(2). In order to notify the public of the existence of such information submitted after the application was filed and not

included in the specification, an appropriate mention will be printed on the cover page of the patent specification.

#### **2.4 Revision of stated technical problem**

Care must also be taken to ensure that any amendment to, or subsequent insertion of, a statement of the technical problem solved by the invention meets Art. 123(2). For example it may happen that following restriction of the claims to meet an objection of lack of inventive step, it is desired to revise the stated problem to emphasise an effect attainable by the thus restricted invention but not by the prior art.

It must be remembered that such revision is only permissible if the effect emphasised is one deducible by a person skilled in the art without difficulty from the application as filed (see H-V, 2.1 and 2.2 above).

If the suggested amendment would contravene Art. 123(2), it will be necessary to amend the description in some other way, e.g. by defining the problem in more general terms or by omitting any express statement of the problem altogether.

#### **2.5 Reference document**

Features from a cross-referenced document can, under particular conditions be introduced by way of amendment into the claims of an application (see H-IV, 2.3.1).

#### **2.6 Alteration, excision or addition of text in the description**

Alteration or excision of the text, as well as the addition of further text, may introduce fresh subject-matter. For instance, suppose an invention related to a multi-layer laminated panel, and the description included several examples of different layered arrangements, one of these having an outer layer of polyethylene; amendment of this example either to alter the outer layer to polypropylene or to omit this layer altogether would not normally be allowable. In each case, the panel disclosed by the amendment example would be quite different from that originally disclosed and, hence, the amendment would introduce fresh subject-matter and therefore be unallowable.

### **3. Amendments in claims**

#### **3.1 Replacement or removal of a feature from a claim**

The replacement or removal of a feature from a claim does not violate Art. 123(2) if the skilled person would directly and unambiguously recognise that:

- (i) the feature was not explained as essential in the disclosure;
- (ii) the feature is not, as such, indispensable for the function of the invention in the light of the technical problem the invention serves to solve; and

- (iii) the replacement or removal requires no real modification of other features to compensate for the change.

In case of a replacement by another feature, the replacing feature must of course find support in the original application documents, so as not to contravene Art. 123(2) (see T 331/87).

### 3.2 Inclusion of additional features

A claim may be limited by inclusion of additional features, provided the resulting combination was originally disclosed and does not relate to an invention which was not searched, for example:

- (a) from dependent claims, which were dependent on the claim to be limited
- (b) from the description e.g. the examples
- (c) from drawings (see H-V, 6)
- (d) arising from the conversion of an independent claim to a dependent claim.

#### 3.2.1 Intermediate generalisations

Extracting a specific feature in isolation from an originally disclosed combination of features and using it to delimit claimed subject-matter may be allowed only if there is no structural and functional relationship between the features.

When evaluating whether the limitation of a claim by a feature extracted from a combination of features fulfils the requirements of Art. 123(2), the content of the application as filed must not be considered to be a reservoir from which individual features pertaining to separate embodiments can be combined in order to artificially create a particular combination.

When a feature is taken from a particular embodiment and added to the claim, it has to be established that:

- the feature is not related or inextricably linked to the other features of that embodiment and
- the overall disclosure justifies the generalising isolation of the feature and its introduction into the claim.

These conditions should be understood as an aid to assessing, in the particular case of an intermediate generalisation, if the amendment fulfils the requirements of Art. 123(2). In any case it has to be ensured that the skilled person is not presented with information which is not directly and unambiguously derivable from the originally filed application, even when account is taken of matter which is implicit to a person skilled in the art using his common general knowledge.

*Example 1*

The amended claim relates to a heddle for the harness of a loom. The original claim was limited by introducing features that were disclosed only in connection with a specific embodiment in which the eyelet of the heddle had the shape of a spindle. This shape was not included in the amended claim. In the general part of the description it was also mentioned that the eyelet could also have other shapes such as an elliptic shape. Therefore the Board concluded that the amendment was allowable under Art. 123(2) (T 300/06).

*Example 2*

The subject-matter of new independent claim 4 relating to a method of telepayment was limited with respect to original independent claim 1 by adding only some features of a specific embodiment disclosed in the application as originally filed. This was defined by the Board using the term "intermediate generalisation" or "intermediate restriction". The Board held that omitting features of an embodiment would introduce new information if these features are necessary for carrying out this embodiment. In the present case, the omitted features were considered to have their own recognisable function independent from the functioning of the rest of the system. Since they were neither presented as essential in the original application nor recognised as essential by the skilled person to carry out the invention, the Board considered that the requirements of Art. 123(2) were met (T 461/05).

*Example 3*

Claim 1 relates to a water dispersible and flushable absorbent article. Amended claim 1 specifies that each of the first and second fibrous assemblies is a wet laid tissue. The application as filed referred, in connection with the first fibrous assembly, to a wet laid tissue in combination with other features (tissue is apertured; tissue is provided with fibrils or sufficient inherent porosity).

Since the first fibrous assembly is disclosed in the application as filed as being a wet laid tissue only in combination with other features which are not present in claim 1, the amendments made constitute a generalisation of the originally disclosed technical information and thereby introduce subject-matter extending beyond the content of the application as filed (T 1164/04).

*Example 4*

Original claim 1 relates to a coating composition comprising at least one rosin compound, at least one polymer and an antifoulant.

After amendment a new claim was introduced relating to a method for preparing a coating composition comprising the mixing of at least one rosin compound, at least one polymer and an antifoulant. The only basis for the method is the examples. The Board observed that for

some solutions the amount of added rosin was extremely low whereas for others it was extremely high. The subject-matter of the amended claim was considered to be an unallowable generalisation of the examples, since nothing in the description indicated to the person skilled in the art that the observed variations were not essential to make a coating composition (T 200/04).

#### *Example 5*

Original claim 1 relates to a multi-processing system comprising a shared memory, a directory and a serialisation point. The serialisation point is defined in functional terms. Claim 1 was amended by adding features that were addressed in the description as part of the cache coherence strategy. The Board held that the incorporated features, albeit disclosed as such, had been isolated in an arbitrary manner from the overall disclosure of the cache coherent memory access architecture. At least one feature had been omitted although its function was presented as being essential to achieving cache coherence. Therefore amended claim 1 was not directly and unambiguously derivable from the original application (T 166/04).

### **3.3 Deletion of part of the claimed subject-matter**

It is permissible to delete parts of the claimed subject-matter if the corresponding embodiments were originally described, e.g. as alternatives in the claim or as embodiments explicitly set out in the description.

#### *Example:*

Original application: "A polymer blend XY ... containing, as a filler, graphite, talc, asbestos or silica"  
Prior art: "A polymer blend XY ... containing asbestos".  
Limited claim: "A polymer blend XY ... containing, as a filler, graphite, talc or silica".

However, deletions made from more than one list are normally not allowable (T 12/81).

In some cases it may be possible to limit the claim by a positive indication of what then remains, rather than by stating what is being deleted (as a disclaimer would do).

#### *Example:*

– "... a polyether of molecular weight from 600 to 10 000" restricted to "... above 1 500 to 10 000" (T 433/86).

### **3.4 Broadening of claims**

A statement regarding use or intended purpose in an independent product claim may be deleted only if the application as filed offers a basis for the assumption that the product can also be used in some

other way (and if the statement of purpose does not amount to a functional limitation).

The broadening of a claim by exchanging a particular feature for a more general feature cannot be based on an indication that it would be obvious for a skilled person (see also H-V, 3.2.1).

### **3.5 Disclaimer disclosed in the application as originally filed**

In this case, the original application already indicates that the disclaimed embodiment is not part of the invention.

Negative features help to define the claimed invention in the same way as positive ones, and must be examined on the same basis. In other words, they may confer novelty and, like positive features, should be assessed as to their relevance to inventive step. They must also fulfil the requirements of Art. 84 (clarity, conciseness and support), and their inclusion must not infringe Art. 123(2) (T 170/87, T 365/88).

*Examples:*

- "... said delivery means does not comprise a capacitor element";
- "... with the proviso that blends having a melt index of lower than 0.05 are excluded".

Negative features, like positive ones, may be structural or functional, and may relate to either a physical entity or an activity.

## **4. Disclaimers not disclosed in the application as originally filed**

### **4.1 The subject-matter to be excluded is not disclosed in the application as originally filed (so-called undisclosed disclaimers)**

Limiting the scope of a claim by using a "disclaimer" to exclude a technical feature not disclosed in the application as filed may be allowable under Art. 123(2) in the following cases (see G 1/03 and G 2/03, and F-IV, 4.20):

- (i) restoring novelty over a **disclosure under Art. 54(3)**;
- (ii) restoring novelty over an **accidental anticipation** under Art. 54(2). "An anticipation is accidental if it is so unrelated to and remote from the claimed invention that the person skilled in the art would never have taken it into consideration when making the invention". The status of "accidental" should be ascertained without looking at the available further state of the art. A related document does not become an accidental anticipation merely because there are other disclosures even more closely related. The fact that a document is not considered to be the closest prior art is insufficient for achieving the status of "accidental". An accidental disclosure has nothing to do with the teaching of the claimed invention, since it is not relevant for



examining inventive step. For example, this is the case when the same compounds serve as starting materials in entirely different reactions yielding different end products (see T 298/01). A prior art, the teaching of which leads away from the invention, however, does not constitute an accidental anticipation; the fact that the novelty destroying disclosure is a comparative example is also insufficient for achieving the status of "accidental" (see T 14/01 and T 1146/01);

- (iii) removing subject-matter which, under Art. 52 to Art. 57, is excluded from patentability for **non-technical reasons**. For example, the insertion of "non-human" in order to satisfy the requirements of Art. 53(a) is allowable.

However, the introduction of the undisclosed disclaimer should not lead, for example, to the singling out of compounds or sub-classes of compounds or other so-called intermediate generalisations not specifically mentioned or implicitly disclosed in the application as filed (see G 2/10). More generally, the test applicable under Art. 123(2), as defined by G 2/10 (see H-V, 4.2), also applies to so-called undisclosed disclaimers (see T 1176/09).

An undisclosed disclaimer is **not** allowable if:

- (i) it is made in order to exclude **non-working embodiments** or remedy **insufficient disclosure**;
- (ii) it makes a **technical contribution**.

An undisclosed disclaimer is, **in particular, not** allowable in the following situations:

- (i) the limitation is relevant for assessing inventive step;
- (ii) the disclaimer, which would otherwise be allowable on the basis of a conflicting application alone (Art. 54(3)), renders the invention novel or inventive over a separate prior art document under Art. 54(2), which is a **not accidental** anticipation of the claimed invention;
- (iii) the disclaimer based on a conflicting application removes also a deficiency under Art. 83;

A disclaimer should remove no more than is necessary either to restore novelty or to disclaim subject-matter excluded from patentability for non-technical reasons. A claim containing a disclaimer must meet the clarity and conciseness requirements of Art. 84. In the interest of the patent's transparency, the excluded prior art should be indicated in the description in accordance with Rule 42(1)(b) and the relation between the prior art and the disclaimer should be shown.

#### **4.2 The subject-matter to be excluded is disclosed in the application as originally filed**

The test to be applied is whether the skilled person would, using common general knowledge, regard the remaining claimed subject-matter as explicitly or implicitly, but directly and unambiguously, disclosed in the application as filed (G 2/10, Headnote 1a).

This test is the same as that applied when the allowability of a limitation of a claim by a positively defined feature is to be determined (see H-V, 3.2).

When it comes to determining whether, after the introduction of the disclaimer, the claim infringes Art. 123(2) or whether it is in conformity with it, this cannot be decided solely by establishing that the disclaimed subject-matter is disclosed in the application as filed.

Whether the skilled person is presented with new information depends on how he or she would understand the amended claim, i.e. the subject-matter remaining in the amended claim and on whether, using common general knowledge, he or she would regard that subject-matter as at least implicitly disclosed in the application as filed.

What is required is an assessment of the overall technical circumstances of the individual case under consideration, taking into account the nature and extent of the disclosure in the application as filed, the nature and extent of the disclaimed subject-matter and its relationship with the subject-matter remaining in the claim after the amendment.

In this respect it has to be established whether the disclaiming of subject-matter leads for example to the singling out of compounds or sub-classes of compounds or other so-called intermediate generalisations not specifically mentioned or implicitly disclosed in the application as filed (see G 2/10).

#### **5. Amendments to drawings**

It sometimes occurs that the drawings used for publication of the application are not those originally filed but are subsequently filed drawings, because the latter are more suitable for reproduction (for drawings filed under Rule 56, see A-II, 5 and sub-sections). In this case, the formalities officer in the Receiving Section will check that the subsequently filed drawings are identical to the originals.

However, the ultimate responsibility for ensuring that the subsequently filed drawings do not contain new technical information, which would conflict with Art. 123(2), rests with the Examining Division.

If the examiner considers that these drawings conflict with Art. 123(2), he should require the applicant to submit other drawings which correspond exactly in substance to the drawings originally filed.

It should be noted that it will not normally be possible under Art. 123(2) to add completely new drawings to an application, since in most cases a new drawing cannot be unambiguously derivable from the mere text of the description. For the same reasons amendments to drawings should be carefully checked for compliance with Art. 123(2).

## **6. Amendments derived from drawings**

Care should be taken when amendments are based on details which may only be derived from the schematic drawings of the original application (see also H-IV, 2.5). The manner in which a particular feature is depicted in the drawings may be accidental. In such cases, the skilled person must be able to clearly and unmistakably recognise from the drawings, in the context of the whole description, that the added feature is the deliberate result of the technical considerations directed to the solution of the technical problem involved.

For example, the drawings may depict a vehicle in which approximately two thirds of the height of the engine is located below a plane tangent to the top of the wheels. An amendment which defines that the major portion of the engine is located below the given level would not infringe Art. 123(2) if the skilled person would recognise that such a spatial arrangement of the engine with respect to the wheels is in fact a deliberate measure directed to the solution of the technical problem (see T 398/00).

## **7. Changes in claim category**

An amendment can be in the form of a change in the category of a claim, possibly combined with a change in the technical features of the invention. Firstly it must be clear that this amendment is necessitated by grounds of opposition (see H-II, 3.1). If that is not the case a change of category should be refused.

*Rule 80  
Art. 123(3)*

Even if this condition is fulfilled, the Opposition Division should exercise great caution in allowing a change of claim category, since the protection as conferred by the claims may thus be extended (Art. 123(3)). Examples are given in the following sections.

### **7.1 Product claim to use claim**

If a patent is so amended that a claim to a product (a physical entity) is replaced by a claim to the use of this product, the degree of protection is not extended, provided that the use claim in reality defines the use of a particular physical entity to achieve an effect and does not define such a use to produce a product (see G 2/88).

### **7.2 Product claim to method claim**

If a patent is so amended that a claim to a product is replaced by a claim to a method for producing the product, this change of category is allowable, provided that the method now claimed only results in the product previously claimed. As it is a fundamental principle of European patent law that the protection conferred by a product claim covers all methods for production of the product, the limitation to one of

these methods cannot extend the protection conferred originally (see T 5/90 and T 54/90).

### **7.3 Method claim to product claim**

If a patent is so amended that a claim to a method of operating a device is replaced by a claim directed to the device itself, this change of category is allowable, provided that the original claim contains the claimed features of the device exhaustively, whether in structural or functional terms (see T 378/86 and T 426/89).

If, however, the device as now claimed is for its features no longer dependent on the circumstances of its operation whereas it depended on them under the terms of the prior method claim, then such a change of category should not be allowed (see T 82/93);

By contrast, the change in claim category from a method in which an apparatus is used to the apparatus itself is not allowable (see T 86/90).

### **7.4 Method claim to use claim**

The change from a process for the preparation of a product to the use of the product for a purpose other than previously claimed is not allowable (see T 98/85 and T 194/85).

On the other hand, the change in a claim from a method in which a certain product is used to a claim to the use of that product in performing that same method is allowable (see T 332/94).

## **8. Changes in the title**

The sole purpose of the title is to inform the public about the technical information disclosed in the application. The title has no bearing on the content of the application as filed or on the protection conferred by the patent, once granted. Furthermore, the title is not part of the documents to be approved by an applicant before a patent can be granted.

Thus the ultimate responsibility for the title rests with the Division, and the examiner is free to ignore any request from the applicant for a change in the title (see also A-III, 7).

## Chapter VI – Correction of errors

### 1. Introduction

Patent specifications may contain errors in the bibliographic data, the description, the claims or the drawings. Errors may also occur in printing the specification, in the decision to grant or in other decisions of the EPO.

These errors can be corrected as set out below.

### 2. Errors in bibliographic data

Correction of these errors is the responsibility of the formalities officer unless the error is in the decision (e.g. the decision recites the wrong priority number in the summary of facts and submissions), in which case correction is the responsibility of the Examining/Opposition Division.

### 3. Errors in publication

Errors in publication occur where the content of the printed specification differs from the documents transmitted to the applicant with the communication under Rule 71(3), which form the basis of the decision to grant.

Errors of this kind can be corrected at any time (see also C-V, 10).

A complete republication of the patent specification will take place where appropriate.

### 4. Corrections of errors in application and patent documents during proceedings

*Rule 139*

These are linguistic errors, errors of transcription and mistakes in documents filed with the EPO (see H-VI, 4.2.1).

#### 4.1 Admissibility of corrections

Corrections of this kind are possible only if proceedings are pending before the EPO. Requests for correction under Rule 139 are dealt with by the department responsible for the proceedings.

#### 4.2 Allowability of corrections

Correction of errors is a special form of amendment, and the requirements of Art. 123(2) therefore apply *mutatis mutandis*.

*Rule 139*  
*Art. 123(2)*

If a request for correction does not comply with Rule 139, and the applicant or patent proprietor maintains the request, the proposed change in the text is to be treated as an amendment and must comply with Art. 123(2) and, where applicable, Art. 123(3).

#### **4.2.1 Correction of description, claims and drawings**

Linguistic errors, errors of transcription and other mistakes in any document filed with the EPO may be corrected at any time, as long as proceedings are pending before the EPO. However, where the mistake is in the description, claims or drawings, both the error and the correction must be such that it is immediately evident (at least once attention is directed to the matter):

- (i) that an error has occurred; and
- (ii) what the correction should be.

Regarding (i), the incorrect information must be objectively recognisable for a skilled person, using common general knowledge, from the originally-filed application documents (description, claims and drawings) taken by themselves.

Regarding (ii), the correction should be within the limits of what a skilled person would derive directly and unambiguously, using common general knowledge, and seen objectively and relative to the date of filing, from the originally-filed application documents.

Evidence of what was common general knowledge on the date of filing may be furnished in any suitable form.

The priority documents cannot be used for the purposes mentioned under (i) and (ii) above (see G 3/89 and G 11/91).

Correction under Rule 139, second sentence, is of a strictly declaratory nature and establishes what a skilled person, using common general knowledge, would already derive on the date of filing from the parts of a European patent application, seen as a whole, relating to the disclosure (see G 3/89 and G 11/91 mentioned above). Therefore, the complete replacement of the application documents (i.e. description, claims and drawings) by other documents is not possible (see G 2/95).

However, during examination proceedings it is to be noted that such requests for correction can be considered only until such time as the decision to grant has been handed over to the EPO's internal postal service, for transmittal to the applicant (in written proceedings), or has been pronounced in oral proceedings (see G 12/91).

#### **4.2.2 Missing parts of description and missing drawings filed as corrections under Rule 139**

The applicant may also request that missing parts of the description and/or missing drawings be included in the application documents by way of a correction according to Rule 139. In virtually all cases this will not be possible (see J 1/82).

In **extremely rare cases** the other application documents might allow the skilled person to reconstruct the missing parts of the description and/or missing drawings such that they may be filed by way of a correction according to Rule 139.

By contrast with missing parts of the description and/or missing drawings filed under Rule 56(3), corrections under Rule 139 can never be filed by reference to the priority document (see H-VI, 4.2.1).

### 4.3 Examples

Corrections of clerical or grammatical errors are usually allowed, insofar as it is evident that an error has occurred and what the correction should be.

Some examples of allowable corrections:

- (i) the replacement of "respectfully" by "respectively" in a claim. (T 34/03)
- (ii) the addition of a plural "s" to the word "particle" as the corresponding verb "have" was in the plural form, and the application as originally filed described a particle size distribution. Since particle size distributions can be defined only for a plurality of particles, the correction was held allowable. (T 108/04)

On the other hand, an applicant cannot rely on:

- (i) a mere count of the number of instances of the relevant words in the application as originally filed for obtaining the replacement of one word by another word, for instance the substitution of "included" for "excluded", if it is not clear that an error has occurred and not possible to ascertain that nothing other than "included" was intended by the drafter. (T 337/88)
- (ii) usual practice or industry standards for measuring concentrations of compounds in the relevant technical field, if the application as originally filed merely refers to "%", without clarification as to whether by weight or volume, and the description contains no clear guidance as to whether "%" refers to concentration by % by weight or % by volume or to something different. (T 48/02)
- (iii) common general knowledge in the absence of further evidence, such as an encyclopaedia or basic textbook, to argue for instance that the skilled person would have immediately recognised that an ASTM standard with a six-digit number did not exist before the priority date of a patent. (T 881/02)

## **5. Correction of errors in decisions and related application and patent documents**

### **5.1 Admissibility of corrections**

Correction of errors in decisions must be clearly distinguished from correction of errors in documents filed by the applicant (or patentee) pursuant to Rule 139. For the latter, see A-V, 3 and H-VI, 4.2 and subparagraphs. Correction of errors made by the applicant (or patentee) in application (or patent) documents cannot be arrived at in a roundabout manner through correction of the decision to grant (or maintain in amended form).

#### *Rule 140*

Correction of a decision is admissible only if the text of the decision is manifestly other than intended by the department concerned. Thus only linguistic errors, errors of transcription and obvious mistakes in decisions can be corrected. The correction of a mistake in a decision under Rule 140 has a retrospective effect (see T 212/88). Therefore, when the decision to be corrected is the refusal of the application or the revocation of the patent, the limit date for filing an appeal is not changed by the corrected decision.

Rule 140 is not available to correct errors in documents filed by a patent applicant or proprietor (G 1/10). Correction of such documents is admissible only under Rule 139 until the patent is granted (see H-VI, 4.2.1). After this point in time, only errors in bibliographic data or printing errors in the publication concerning the decision to grant or to maintain the patent in amended form may be corrected (see H-VI, 3 and 5.2).

It is the duty of the applicant or patentee to properly check the documents as proposed for grant or for maintenance in amended form, respectively (see Rules 71(5), 82(2) and 95(2), 95 (3) and G 1/10).

Corrections of decisions are to be made by a decision at the reasoned request of one of the parties or by the EPO of its own motion. If the request for correction is refused, this decision must be reasoned (see T 850/95). These reasons must previously have been communicated to the requester (Art. 113(1)).

The competence to correct errors lies with the body which took the decision. Hence, even during opposition proceedings, the Examining Division is competent for correcting errors in bibliographic data contained in the decision to grant.

### **5.2 Allowability of correction of bibliographic data**

The sole reason for allowing correction of linguistic errors, errors of transcription and obvious mistakes is to ensure that the decision says what the Division actually intended at the time of issue. If the bibliographic data referred to in the decision to grant, to maintain the patent in amended form or to limit the patent is not and obviously cannot be the bibliographic data corresponding to the real intention of



the Division, the bibliographic data erroneously indicated can be corrected under Rule 140.

### **5.3 Correction of the translations of the claims**

According to Art. 70(1), the text of a patent in the language of the proceedings is the authentic text. It therefore follows that the translations of the claims of the patent specification required by Art. 14(6) are for information only. Hence no examination of the translations takes place (C-V, 1.3); in particular, the translations do not form part of the decision to grant the patent. Therefore they cannot be corrected under Rule 140, either.

Hence the only possibilities for the patent proprietor to amend translations are when the patent is maintained in amended form (Rule 82(2)) or, as indicated in Art. 70(4), before a national authority.

Published by the European Patent Office  
Directorate Patent Law 5.2.1  
D-80298 Munich  
Tel.: (+49-89) 2399-5116  
Fax: (+49-89) 2399-5153  
*patentlaw@epo.org*  
*http://www.epo.org*

Printed by:  
Mediengruppe Universal, Munich

Printed in Germany

© European Patent Office  
ISBN 978-3-89605-133-2